

# ASSEMBLY INSTRUCTIONS

## Round Edge 3-Drawer Mobile Cabinet

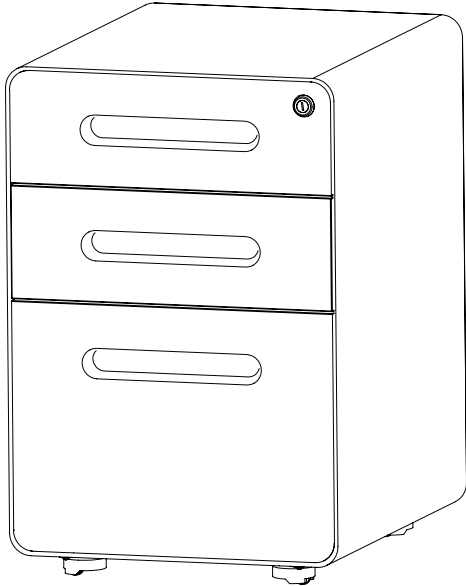

### Tools Required For Assembly

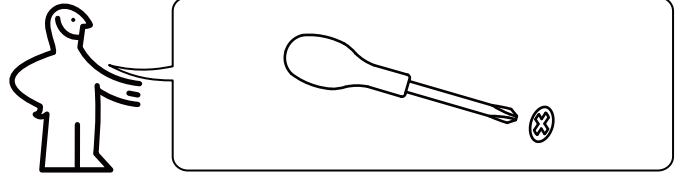

### Assemble Item On a Clean Flat Surface

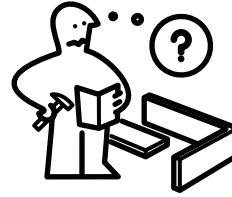
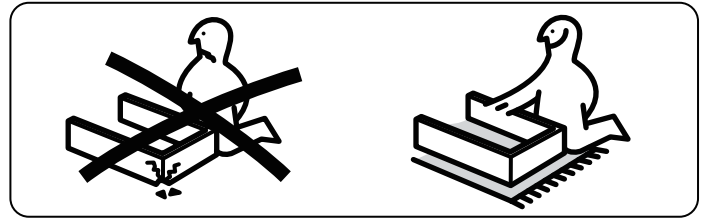

- Please check you have all hardware before assembling.
- Please ensure you have the name of the item and hardware part required and quantity.
- Please contact us by mail, if you have any questions, and we will reply you ASAP.
- Enjoy your new purchase!

### EXPLODED DRAWING:



### REMARK:

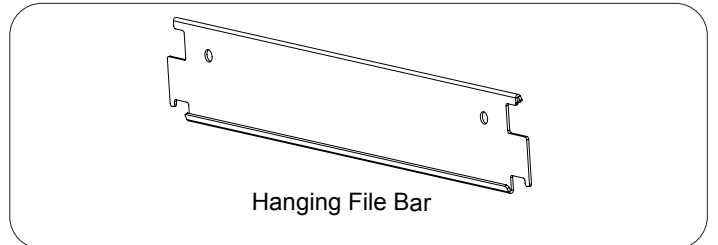

### PARTS:

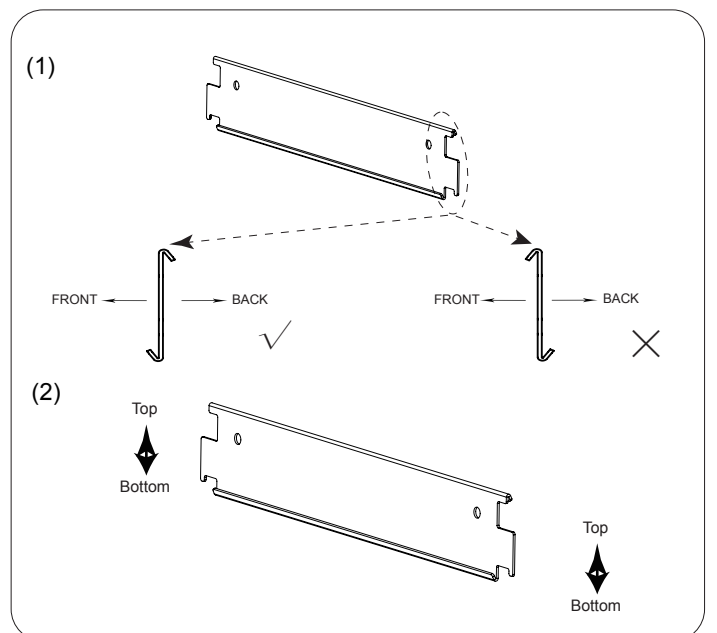
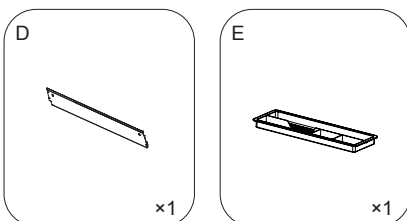
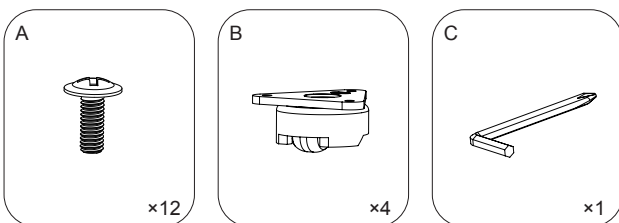

1.

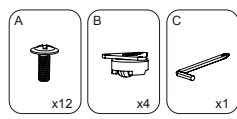
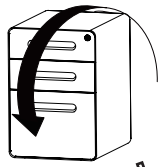

One filing drawer support A4, legal, letter size file folders

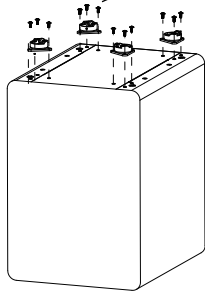
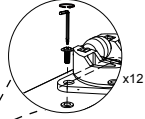

2.

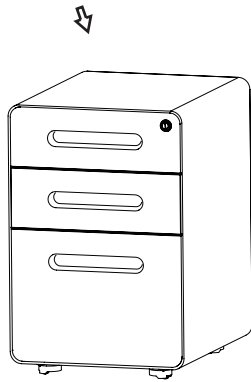
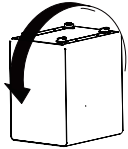

3. The position of hanging bars for A4 size files

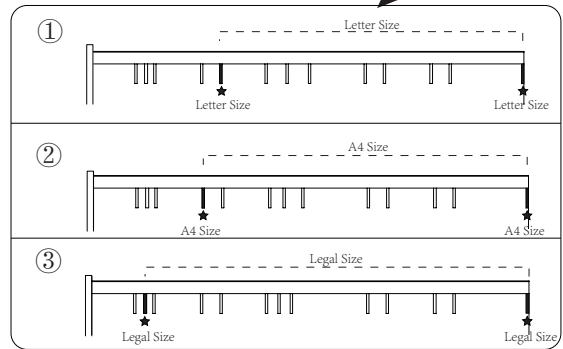
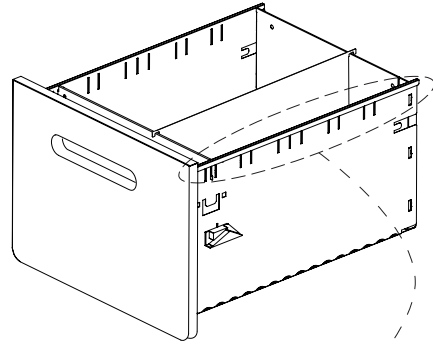
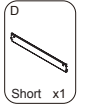

REMARK:

Install or adjust the hanging file bar, please follow the below method

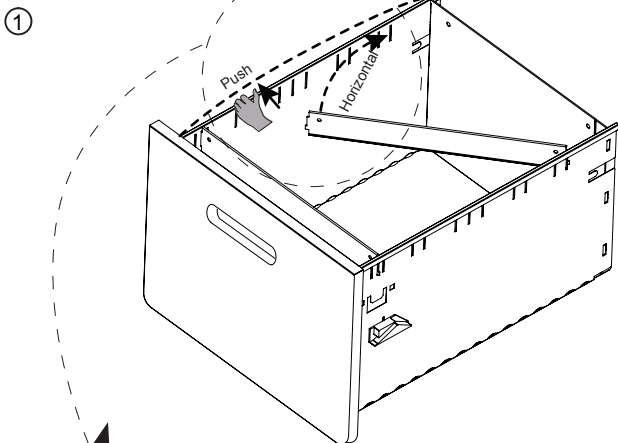

Please do not vertically install the hanging file bar, especially in the front or back of the filing drawer, otherwise it will be difficult to install.

