

INSTALLATION

Installation Overview

Please read the following installation instructions first after purchasing this product or transporting it to another location.

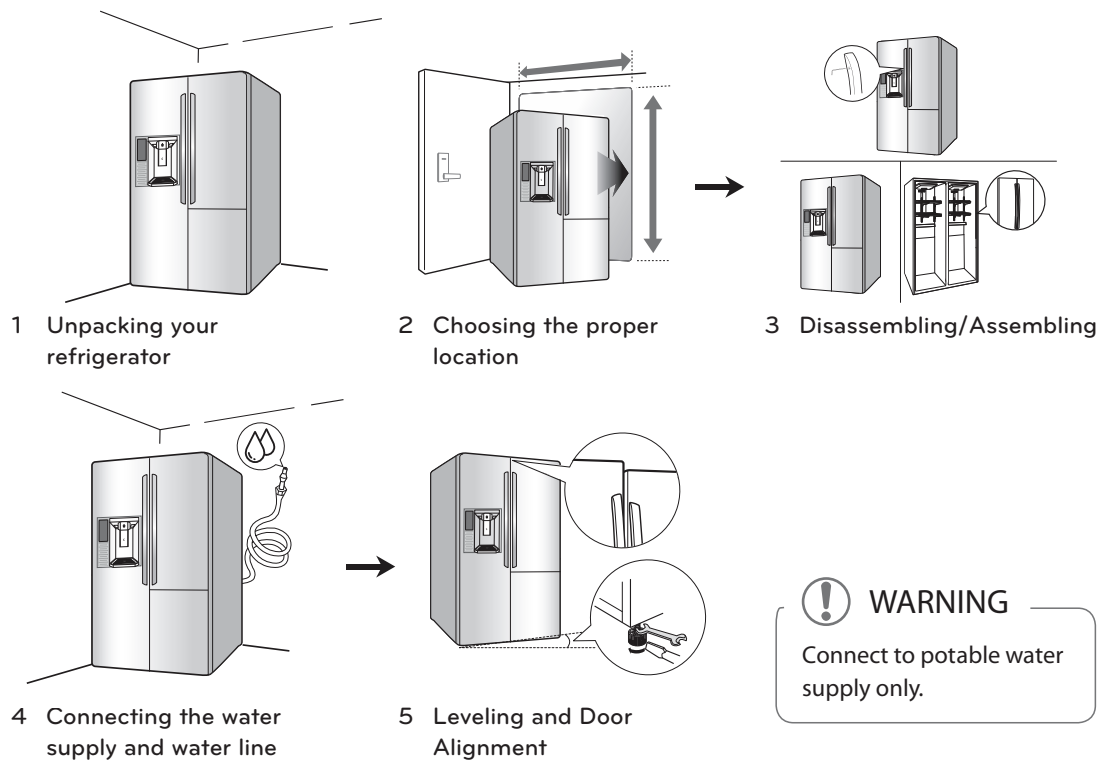

Specifications

The appearance and specifications listed in this manual may vary due to constant product improvements.

Side by Side refrigerator model	
Description	Side by Side refrigerator
Electrical requirements	115 V ~ 60 Hz and fused at 15 A 127 V ~ 60 Hz and fused at 15 A 220 V ~ 50/60 Hz and fused at 10 A (Refer to rating label inside refrigerator compartment).
Min. / Max. Water pressure	20 - 120 psi (138 - 827 kPa) on models without water filter 40 - 120 psi (276 - 827 kPa) on models with filter
Dimensions	35.9 " (W) X 35.9 " (D) X 70.3 " (H), 50.6 " (D w/ door open) 912 mm (W) X 912 mm (D) X 1785 mm (H), 1286 mm (D w/ door open)
Net weight	DID Model: 303.6 lb (138 kg) Basic Model Vertical: 277.8 lb (126 kg) Basic Model Horizontal: 264.3 lb (120 kg)

Unpacking Your Refrigerator



WARNING

- Use two or more people to move and install the refrigerator. Failure to do so can result in back or other injury.
- Your refrigerator is heavy. When moving the refrigerator for cleaning or service, be sure to protect the floor. Always pull the refrigerator straight out when moving it. Do not wiggle or walk the refrigerator when trying to move it, as floor damage could occur.
- Keep flammable materials and vapors, such as gasoline, away from the refrigerator. Failure to do so can result in fire, explosion, or death.

Remove tape and any temporary labels from your refrigerator before using. Do not remove any warning-type labels, the model and serial number label .

To remove any remaining tape or glue, rub the area briskly with your thumb. Tape or glue residue can also be easily removed by rubbing a small amount of liquid dish soap over the adhesive with your fingers. Wipe with warm water and dry.

Do not use sharp instruments, rubbing alcohol, flammable fluids, or abrasive cleaners to remove tape or glue. These products can damage the surface of your refrigerator.

Refrigerator shelves are installed in the shipping position. Please reinstall shelves according to your individual storage needs.

Choosing the Proper Location

- Select a place where a water supply can be easily connected for the automatic icemaker.



NOTE

The water pressure must be between 20 and 120 psi (138 and 827 kPa) on models without a water filter and between 40 and 120 psi (276 and 827 kPa) on models with a water filter.

- The refrigerator should always be plugged into its own individual properly grounded electrical outlet. This provides the best performance and also prevents overloading house wiring circuits which could cause a fire hazard from overheated wires. It is recommended that a separate circuit serving only this appliance be provided.



WARNING

To reduce the risk of electric shock, do not install the refrigerator in a wet or damp area.

Flooring

To avoid noise and vibration, the unit must be leveled and installed on a solidly constructed floor. If required, adjust the leveling legs to compensate for unevenness of the floor. The front should be slightly higher than the rear to aid in door closing. Leveling legs can be turned easily by tipping the cabinet slightly. Turn the leveling legs to the left to raise the unit or to the right to lower it. (See Leveling and Door Alignment.)



NOTE

Installing on carpeting, soft tile surfaces, a platform or weakly supported structure is not recommended.

Ambient Temperature

Install this appliance in an area where the temperature is between 55°F (13°C) and 110°F (43°C). If the temperature around the appliance is too low or high, cooling ability may be adversely affected.

Measuring the Clearances

Too small of a distance from adjacent items may result in lowered freezing capability and increased electricity consumption charges. Allow at least 24 inches (61 cm) in front of the refrigerator to open the doors, and at least 2 inches (5.08 cm) between the back of the refrigerator and the wall as well as on the sides of the refrigerator and adjacent walls or objects.

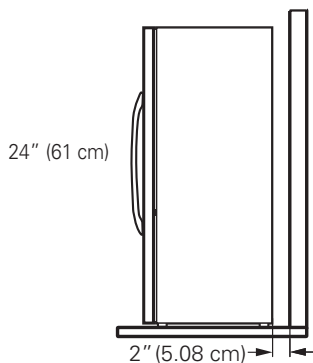

Removing/Assembling the Refrigerator Door Handles

NOTE

When it is necessary to move the refrigerator through a narrow opening, removing the doors is the recommended procedure. If it is necessary to remove the handles, follow the directions below. The appearance of the handle may vary from what is shown in the illustrations

Removing the Handles

- 1 Loosen the set screws with a 3/32 in. Allen wrench and remove the handle.
- 2 Loosen the mounting fasteners that connect to the refrigerator door and handle using a 1/4 in. Allen wrench, remove the mounting fasteners.

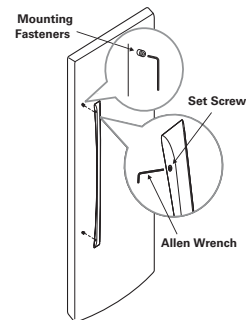

Assembling the Handles

- 1 Assemble the mounting fasteners at both ends of the handle using a 1/4 in. Allen wrench.
- 2 Place the handle on the door by fitting the handle footprints over the mounting fasteners and tightening the set screws with a 3/32 in. Allen wrench.

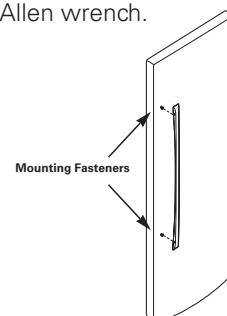

Removing/Assembling the Refrigerator Doors

When it is necessary to move the refrigerator through a narrow opening, removing the doors is the recommended procedure.

WARNING

Electric Shock Hazard

Disconnect electrical supply to refrigerator before installing. Failure to do so could result in death or serious injury.

Before removing freezer door, disconnect water line connectors (one white tube, one blue tube).

NOTE: Do not remove freezer door if either the white or blue tube is still connected. To remove connectors use the support block that is on the upper shelf in the refrigerator.

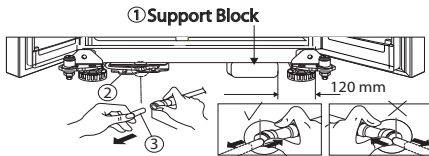

- If your entrance door is too narrow for the refrigerator to pass through, remove the refrigerator doors and move the refrigerator sideways through the doorway. Use two or more people to remove and install the refrigerator doors. Failure to do so can result in back or other injury.
- Disconnect the electrical supply to the refrigerator before installation. Failure to do so could result in serious injury or death.
- Do not put hands, feet or other objects into the air vents or bottom of the refrigerator. You may be injured or receive an electrical shock.
- Be careful when handling the hinge and stopper. You may be injured.
- Remove food and bins before detaching the doors and drawers.

Removing the Left (Freezer) Door with Water Line Connection

1. Loosen the hinge cover screws and remove the hinge cover. Disconnect all wire harnesses.

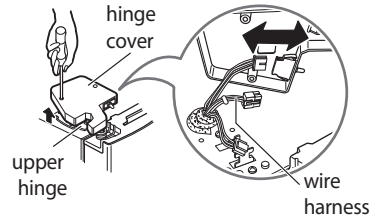

2. Rotate the hinge lever counterclockwise (1) and lift the upper hinge (2).

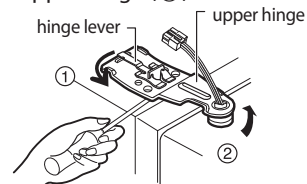

CAUTION

When removing the upper hinge, be careful that the door does not fall forward.

3. Remove the freezer compartment door by lifting it upward. This time, the door should be lifted enough for the water feed tube to be completely pulled out.

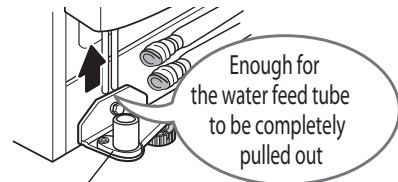

CAUTION

Place the door, inside facing up, on a non-scratching surface. Be careful not to damage the water feed tube.

Removing the Right (Refrigerator) Door

1. Open the door. Remove the top hinge cover screw.
2. Use a flat blade screwdriver to pry back the hooks (not shown) of the hinge cover from the top of the refrigerator cabinet. Lift up the cover. Disconnect all wire harnesses.

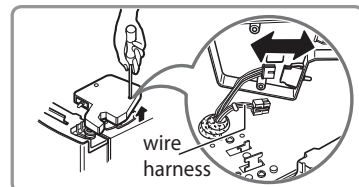

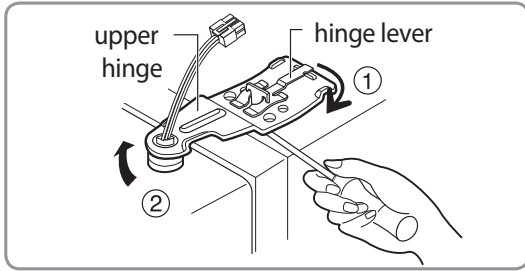

3. Rotate the hinge lever clockwise (1). Lift the upper hinge free of the hinge lever latch (2).



CAUTION

When lifting the hinge free of the latch, be careful that the door does not fall forward.

4. Lift the door from the lower hinge pin.

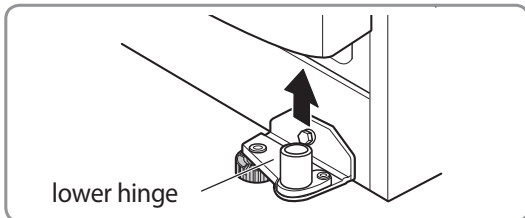

5. Place the door, inside facing up, on a non-scratching surface.



NOTE

- Do not remove the grease on the surface of the gasket or hinge.
- Do not remove the sensor assembly in the right upper hinge cover.

Reinstalling the Right (Refrigerator) Door

1. Place the door onto the lower hinge pin.
2. Fit the upper hinge over the hinge lever latch and into place. Rotate the lever counterclockwise to secure the hinge.
3. Reconnect all wire harnesses. Hook the tab on the switch side of the cover under the edge of the wire opening in the cabinet top. Position the cover and replace the screw.

Reinstalling the Left (Freezer) Door

1. Feed the water tubes through the lower hinge pin and place the door onto the lower hinge pin. Water hoses should be behind the leg to prevent damage.

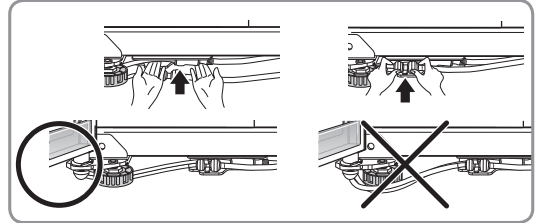

2. Fit the top hinge over hinge lever latch and into place. Rotate the lever clockwise to secure the hinge.
3. Install the grounding screw and connect all the wire harnesses.
4. Hook the tab on the door switch side of the cover, under the edge of the wire, opening in the cabinet top. Position the cover into place. Insert and tighten the cover screw.
5. Reconnect the water tubes by inserting the tubes into the connectors. The tube is inserted correctly when only one guide line is showing out of two.

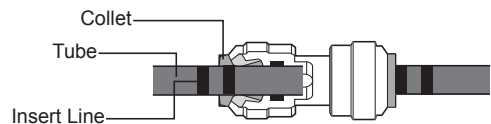

Open the door and turn the hose toward the inside. Water hoses should be behind the leg to prevent damage.

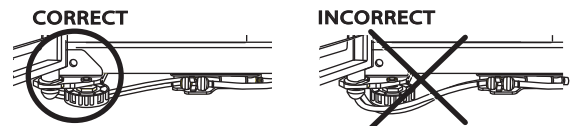

Tube is completely inserted when only one guide line is showing out of two.

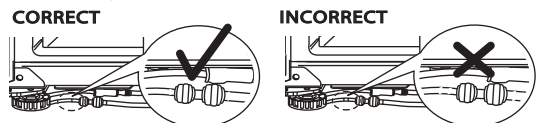

Water hoses should be cut with a clean, straight edge to avoid leaks.



Connecting the Water Line

Before You Begin

This water line installation is not covered by the refrigerator warranty. Follow these instructions carefully to minimize the risk of expensive water damage.

Water hammer (water banging in the pipes) in house plumbing can cause damage to refrigerator parts and can lead to water leakage or flooding. Call a qualified plumber to correct water hammer before installing the water supply line to the refrigerator.

 **CAUTION**

To prevent burns and product damage, only connect the refrigerator water line to a cold water supply.

 **CAUTION**

Do not install the icemaker tubing in areas where temperatures fall below freezing.

Water Pressure

You will need a cold water supply. The water pressure must be between 20 and 120 psi (138 – 827 kPa) on models without a water filter and between 40 and 120 psi (276 – 827 kPa) on models with a water filter. If the water pressure does not reach the minimum required pressure, a separate booster pump may be required for normal automatic icemaker and cool water dispensing operation.

If a reverse osmosis water filtration system is connected to your cold water supply, this water line installation is not covered by the refrigerator warranty. Follow these instructions carefully to minimize the risk of expensive water damage.

If a reverse osmosis water filtration system is connected to your cold water supply, the water pressure to the reverse osmosis system needs to be a minimum of 40 to 60 psi (276 - 413 kPa, or less than 2.0~3.0 sec. to fill a cup of 7 oz capacity).



CAUTION

Wear eye protection during installation to prevent injury.

If the water pressure from the reverse osmosis system is less than 21 psi or 1.5 kgf/cm² (takes more than 4.0 sec to fill a cup of 7 oz capacity):

- Check to see if the sediment filter in the reverse osmosis system is blocked. Replace the filter if necessary.
- Allow the storage tank on the reverse osmosis system to refill after heavy usage.
- If the issue concerning water pressure from reverse osmosis remains, call a licensed, qualified plumber.
- All installations must be in accordance with local plumbing code requirements.

What You Will Need

- **Copper Tubing**, ¼ in. outer diameter, to connect the refrigerator to the water supply. Be sure both ends of the tubing are cut square.

To determine how much tubing you need: measure the distance from the

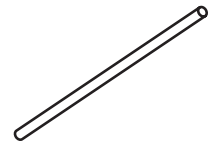

water valve on the back of the refrigerator to the water supply pipe. Then, add 8 feet (2.4 m). Be sure there is sufficient extra tubing (about 8 feet [2.4 m] coiled into 3 turns of about 10 in. [25 cm] diameter) to allow the refrigerator to move out from the wall after installation. Keep the total length of the feed water pipe tube within 26 ft (8 m). Be careful to avoid getting a kink in the tube. If the tube is longer than 26 ft (8 m), it may cause the water feed to malfunction.

- **Power drill.**
- **½ in. or adjustable wrench.**
- **Flat blade and Phillips head screwdrivers.**
- **Two ¼ in. outer diameter compression nuts and 2 ferrules (sleeves)** to connect the copper tubing to the shutoff valve and the refrigerator water valve.

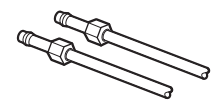
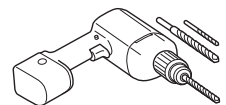

- If your existing copper water line has a flared fitting at the end, you will need an **adapter** (available at plumbing supply stores) to connect the water line to the refrigerator OR you can cut off the flared fitting with a tube cutter and then use a compression fitting.

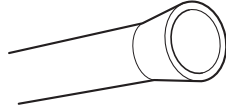

- **Shutoff valve to connect to the cold water line.** The shutoff valve should have a water inlet with a minimum inside diameter of 5/32 in. at the point of connection to the COLD WATER LINE. Saddle-type shutoff valves are included in many water supply kits.

Before purchasing, make sure a saddle-type valve complies with your local plumbing codes.

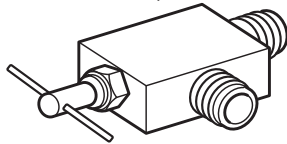
**NOTE**

A self-piercing saddle type water valve should not be used.

**WARNING****Electrical Shock Hazard:**

When using any electrical device (such as a power drill) during installation, be sure the device is battery powered, double insulated or grounded in a manner that will prevent the hazard of electric shock.

Water Line Installation Instructions

WARNING

- When using any electrical device (such as a power drill) during installation, be sure the device is battery powered, double insulated or grounded in a manner that will prevent the hazard of electric shock.

Install the shutoff valve on the nearest frequently used drinking water line.

- 1 SHUT OFF THE MAIN WATER SUPPLY**
Turn on the nearest faucet to relieve the pressure on the line.
- 2 CHOOSE THE VALVE LOCATION**
Choose a location for the valve that is easily accessible. It is best to connect into the side of a vertical water pipe. When it is necessary to connect into a horizontal water pipe, make the connection to the top or side, rather than at the bottom, to avoid drawing off any sediment from the water pipe.

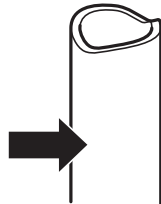

- 3 DRILL THE HOLE FOR THE VALVE**
Drill a 1/4 in. hole in the water pipe using a sharp bit. Remove any burrs resulting from drilling the hole in the pipe. Be careful not to allow water to drain into the drill. Failure to drill a 1/4 in. hole may result in reduced ice production or smaller cubes.

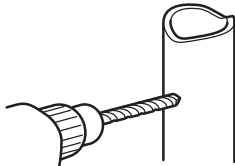

NOTE

The hookup line cannot be white, plastic tubing. Licensed plumbers must use only copper tubing (NDA tubing #49595 or #49599) or Cross Link Polyethylene (PEX) tubing.

- 4 FASTEN THE SHUTOFF VALVE**
Fasten the shutoff valve to the cold water pipe with the pipe clamp.

- 5 TIGHTEN THE PIPE CLAMP**

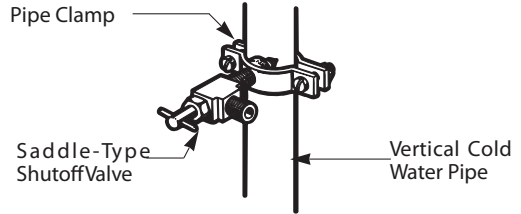

NOTE

Commonwealth of Massachusetts Plumbing Codes 248CMR shall be adhered to. Saddle valves are illegal and use is not permitted in Massachusetts. Consult with your licensed plumber.

Tighten the clamp screws until the sealing washer begins to swell.

NOTE: Do not overtighten clamp or you may crush the tubing.

- 6 ROUTE THE TUBING**

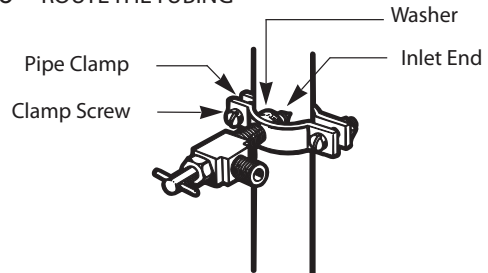

Route the tubing between the cold water line and the refrigerator.

Route the tubing through a hole drilled in the wall or floor (behind the refrigerator or adjacent base cabinet) as close to the wall as possible.

NOTE

Be sure there is sufficient extra tubing (about 8 feet (2,4 m) coiled into 3 turns of about 10 in. (0,25 m) diameter) to allow the refrigerator to move out from the wall after installation.

- 7 CONNECT THE TUBING TO THE VALVE
Place the compression nut and ferrule (sleeve) for copper tubing onto the end of the tubing and connect it to the shutoff valve. Make sure the tubing is fully inserted into the valve. Tighten the compression nut securely.

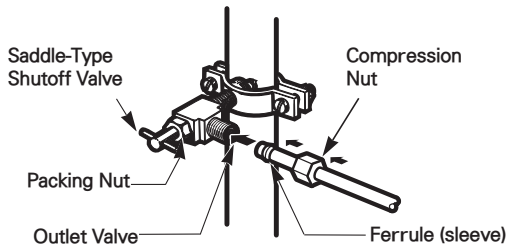

- 8 FLUSH OUT THE TUBING
Turn the main water supply on and flush out the tubing until the water is clear.

Shut the water off at the water valve after about one quart of water has been flushed through the tubing.



- 9 CONNECT THE TUBING TO THE REFRIGERATOR
- NOTE:** Before making the connection to the refrigerator, be sure that the refrigerator power cord is not plugged into the wall outlet.

- Remove the plastic flexible cap from the water valve.
- Place the compression nut and ferrule (sleeve) onto the end of the tubing as shown.
- Insert the end of the copper tubing into the connection as far as possible. While holding the tubing, tighten the fitting.

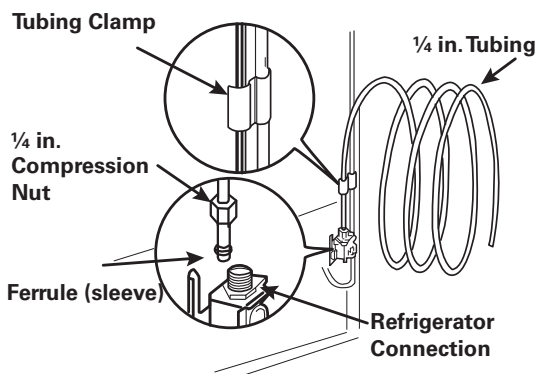

- 10 TURN THE WATER ON AT THE SHUTOFF VALVE
Tighten any connections that leak.

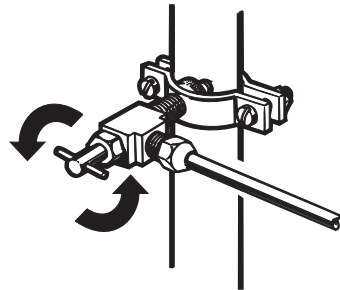

CAUTION

Check to see if leaks occur at the water line connections.

- 11 PLUG IN THE REFRIGERATOR
Arrange the coil of tubing so that it does not vibrate against the back of the refrigerator or against the wall. Push the refrigerator back to the wall.

- 12 START THE ICEMAKER
The icemaker will not begin to operate until it reaches its operating temperature of 15°F (-9°C) or below.

Turning On The Power

- Plug in the refrigerator.

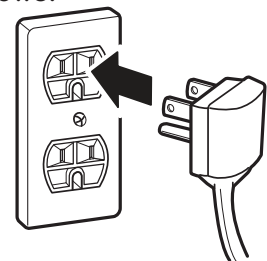

CAUTION

- Connect to a rated power outlet.
- Have a certified electrician check the wall outlet and wiring for proper grounding.
- Do not damage or cut off the ground terminal of the power plug.

Leveling

After installing, plug the refrigerator's power cord into a 3-prong grounded outlet and push the refrigerator into the final position.

Your refrigerator has two front leveling legs—one on the right and one on the left. Adjust the legs to alter the tilt from front-to-back or side-to-side. If your refrigerator seems unsteady, or you want the doors to close more easily, adjust the refrigerator's tilt using the instructions below:

NOTE: Tools Required: 11/16" (18mm) wrench or flat blade screwdriver.

- 1 Turn the leveling leg counterclockwise to raise that side of the refrigerator or clockwise to lower it. It may take several turns of the leveling leg to adjust the tilt of the refrigerator.

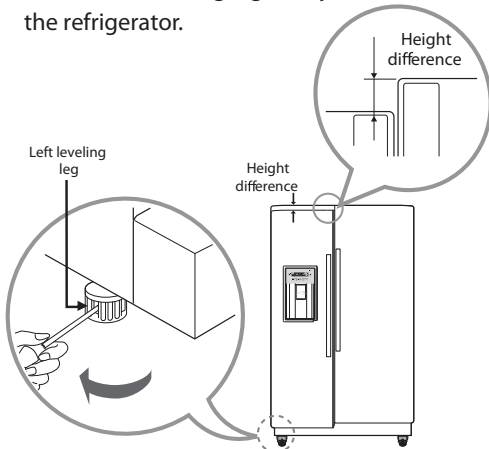

NOTE: Having someone push backward against the top of the refrigerator takes some weight off of the leveling legs. This makes it easier to adjust the legs.

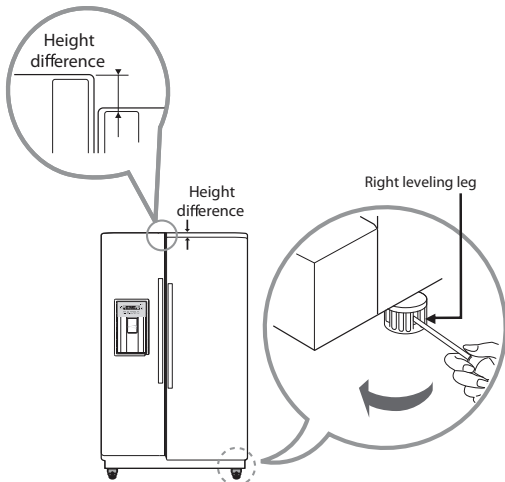

- 2 Open both doors again and check to make sure that they close easily. If the doors do not close easily, tilt the refrigerator slightly more to the rear by turning both leveling legs counterclockwise. It may take several more turns, and you should turn both leveling legs the same amount.

Door Alignment

If the doors are still uneven after the refrigerator has been leveled, finish adjusting the doors by following the instructions below:

Adjusting tools: 5/16" (8mm) wrench and 3/4" (19mm) wrench.

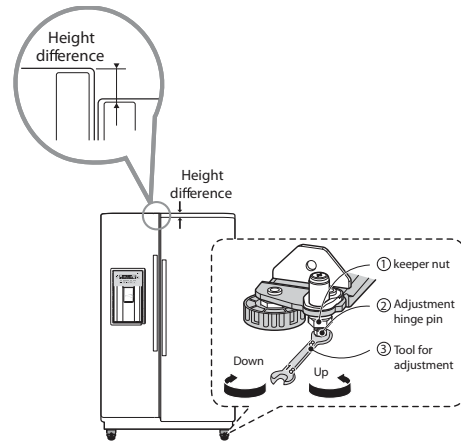

- Using a 3/4" (19mm) wrench, turn the keeper nut counterclockwise to loosen the keeper nut.
- Using a 5/16" (8mm) wrench, turn the adjustment hinge pin clockwise or counterclockwise to level the refrigerator door.
- After leveling the door, turn the keeper nut clockwise to tighten it.

CAUTION: Do not overtighten the door adjustment screw. The hinge pin can be pulled out (adjustable range of height is a maximum of 2 in. (5 cm)).