

**OVAL DOOR MEDICINE CABINET**  
**BOTIQUÍN CON PUERTA OVALADA**

**INSTALLATION INSTRUCTION**  
**INSTRUCCIONES DE INSTALACIÓN**

**PEGASUS**  
**LUXURY AT HAND™**

**UNPACKING**

Care should be taken when you unpack your medicine cabinet.

**DESEMPACAR**

Debe tener cuidado cuando desempaque el gabinete para baño.

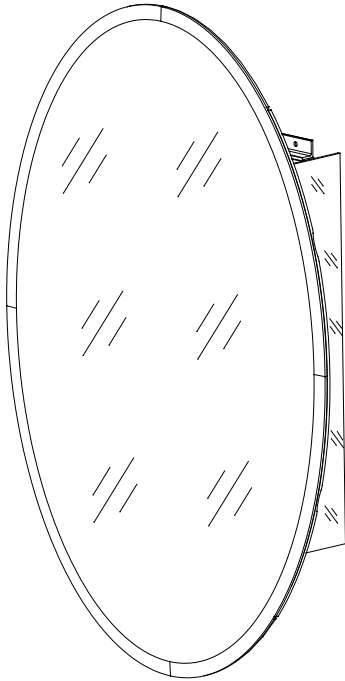

**CLEANING**

Use a household liquid glass cleaner to keep mirror and glass surfaces clean. Do not use abrasive cleaners containing ammonia.

**LIMPIEZA**

Utilice un limpiador de vidrios líquido para mantener limpias las superficies de los espejos y los vidrios. No utilice limpiadores abrasivos que contengan amoníaco.

**TOOLS REQUIRED**

- Measuring tape
- Level
- Philips head screwdriver
- Electric drill for surface mounting

**HERRAMIENTAS NECESARIAS**

- Cinta métrica
- Nivel
- Destornillador Phillips
- Taladro eléctrico para montaje superficial

SURFACE MOUNTED CABINET SHOWN

ILUSTRACIÓN DE GABINETE MONTADO SOBRE UNA  
SUPERFICIE

**BEFORE YOU START**

- Unpack your medicine cabinet with care. Close the sink drain to avoid dropped parts from falling into the drain.
- Before installing your medicine cabinet, determine if you will install your medicine cabinet as a surface or recess mount and which side the door will open.
- Use a stud finder to locate stud in the desired mounting position. If mounting locations align with stud, use stud mounting. If there are no available studs, use anchors and screws for drywall mounting.

**ANTES DE COMENZAR**

- Desempaque el botiquín para baño con cuidado. Cierre el drenaje del lavabo para evitar que las piezas caigan en él.
- Antes de instalar el botiquín para baño, determine si va a instalarlo en superficie o empotrado y para qué lado abrirá la puerta.
- Utilice un detector de vigas para ubicar la viga en el lugar donde desee montar el botiquín. Si las posiciones de montaje se alinean con la viga, utilice el montaje en vigas. Si no hay vigas, utilice anclajes y tornillos para montaje sobre drywall.

**WARNING: SAFELY DISCARD ALL PACKING MATERIAL. KEEP PLASTIC BAGS AND SMALL PARTS AWAY FROM CHILDREN. SAFETY GLASSES SHOULD BE WORN AT ALL TIME.**

**ADVERTENCIA: DESECHE DE FORMA SEGURA TODO EL MATERIAL DE EMPAQUE. MANTENGA LAS BOLSAS PLÁSTICAS Y LAS PIEZAS PEQUEÑAS FUERA DEL ALCANCE DE LOS NIÑOS. DEBE UTILIZAR GAFAS DE SEGURIDAD EN TODO MOMENTO.**

**SPECIFICATION  
ESPECIFICACIONES**

<b>Model number Nº del Modelo</b>	<b>Overall size Tamaño General</b>	<b>Rough wall opening Abertura aproximada en la pared</b>
511279	24 inch x 36 inch x 4-1/2 inch	14-1/8 inch x 25-1/8 inch x 2-5/8 inch
511335	23.25 inch x 29 inch x 5-1/2 inch	13-1/4 inch x 19-1/8 inch x 2-5/8 inch
511398	23.25 inch x 29 inch x 5-1/2 inch	13-1/4 inch x 19-1/8 inch x 2-5/8 inch
511399	23.25 inch x 29 inch x 5-1/2 inch	13-1/4 inch x 19-1/8 inch x 2-5/8 inch
511400	20 inch x 30 inch x 5-1/2 inch	13-1/2 inch x 17-1/2 inch x 2-5/8 inch

**SAVE THESE INSTALLATION INSTRUCTIONS FOR FUTURE REFERENCE. RECORD MODEL NUMBER FROM THE PACKAGE LABEL;  
CONSERVE ESTAS INSTRUCCIONES PARA FUTURAS CONSULTAS ANOTE EL NÚMERO DE MODELO QUE APARECE EN LA ETIQUETA DEL EMPAQUE;**

---

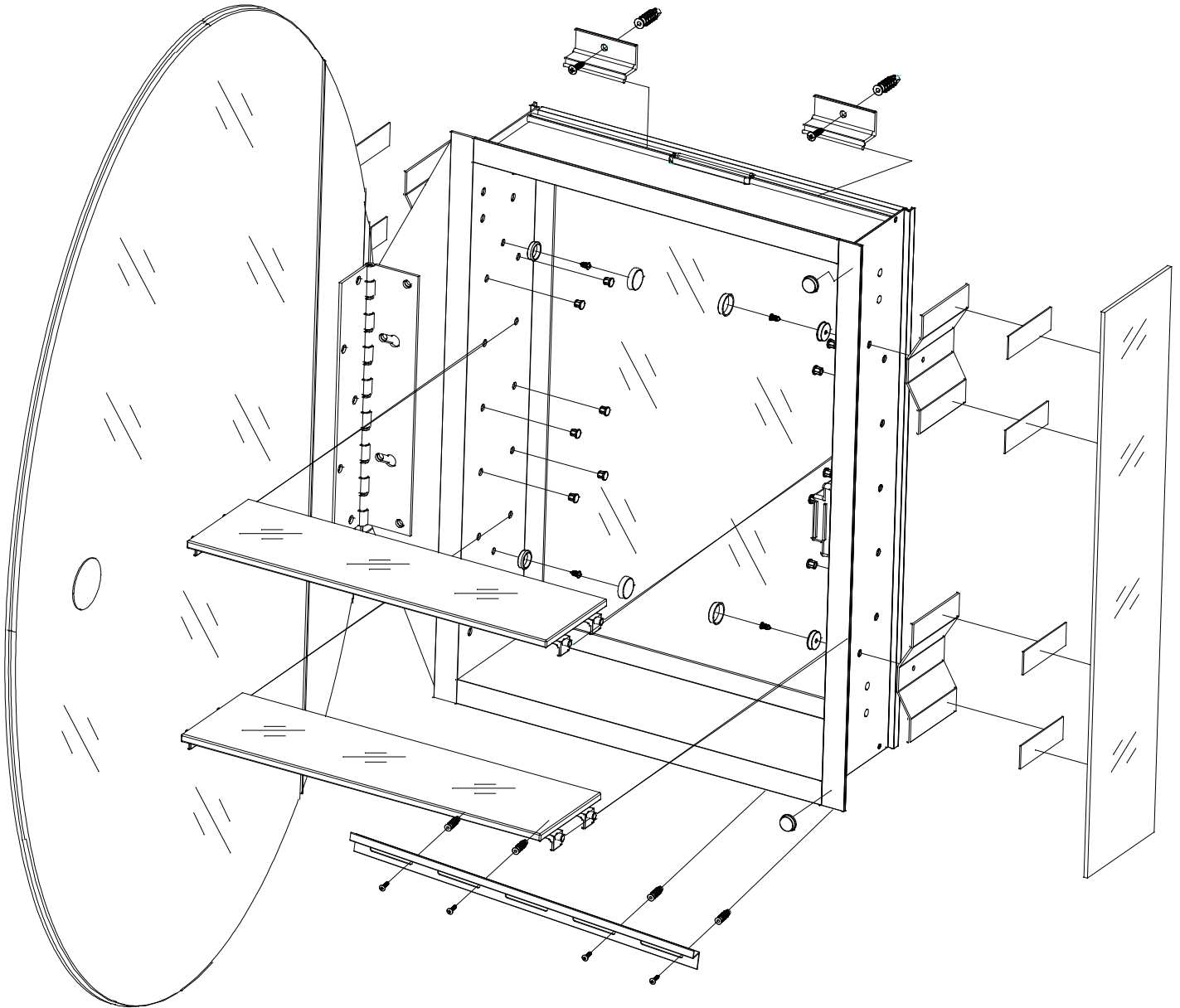

Explode view  
Vista explosiva











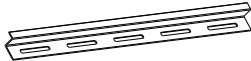
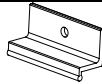

**WARNING:** Use a stud finder to locate the studs inside the wall. Determine the location where you will be mounting your cabinet. If mounting locations on the cabinet line up with the studs, do not use the wall anchor plugs. Mounting brackets must be fastened to studs, joists, headers, or other major structural members.

**Advertencia:** Utilice un detector de montantes para ubicar el montante dentro de la pared. Determine la ubicación donde montará su gabinete. Si las ubicaciones de montaje están alineadas con las de los montantes, no utilice los anclajes para pared. Los soportes de montaje deben estar ajustados a los montantes, juntas, cabezales u otras partes importantes de la estructura.

511279

Kits hardware, including following parts

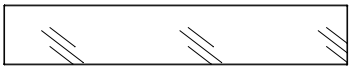

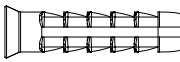
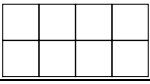
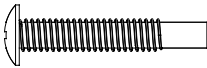
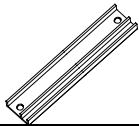
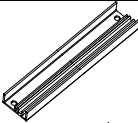
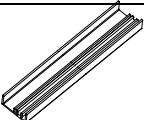







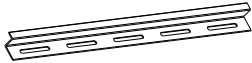
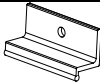



Kits de herrajes, incluyendo las siguientes piezas

Item Artículo	Description Descripción	Drawing Dibujo	Quantity Cantidad
1	Bottom bracket Soporte inferior		1
2	Top clip Ganchos superiores		2
3	Side mirror Espejos laterales		2
4	Side mirror bracket Soportes de espejos laterales		4
5	#8*3/8 inch side mirror bracket screws Tornillos para soportes de espejos los laterales #8*3/8 inch		4
6	Side mirror bracket tape Cinta para soportes de espejos laterales		8
7	Shelf clip Ganchos para estantes		8
8	Shelf hole plug Tapón para orificios de estantes		28
9	Snap cap Tapa a presión		4
10	Washer Arandela		4
11	Bumper Tapa a presión		2
12	Shelf glass Protector de Borde		2
13	#8*1 1/2 inch Philips head screws Tornillos Philips 1-1/2 inch, #8*		4
14	Wall anchors Anclajes para pared		4
15	Shelf clip tape Cinta para ganchos de estantes		8
16	#6*1 inch Philips head screws Tornillos Philips #6*1 inch		4
17	Recess frame (hinge side) Marco empotrado (lado de la bisagra)		1
18	Recess frame (open side) Marco empotrado (lado abierto)		1
19	Recess frame (short) Marco empotrado (corto)		2

511335 & 511398 & 511399 & 511400

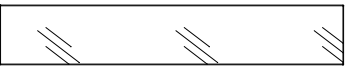
Kits hardware, including following parts

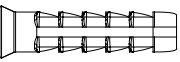
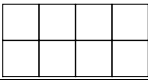
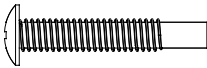
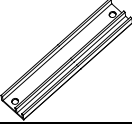
Kits de herrajes, incluyendo las siguientes piezas

Item Artículo	Description Descripción	Drawing Dibujo	Quantity Cantidad
1	Bottom bracket Soporte inferior		1
2	Top clip Ganchos superiores		2
3	Side mirror Espejos laterales		2
4	Side mirror bracket Soportes de espejos laterales		4
5	#8*3/8 inch side mirror bracket screws Tornillos para soportes de espejos los laterales #8*3/8 inch		4
6	Side mirror bracket tape Cinta para soportes de espejos laterales		8
7	Shelf clip Ganchos para estantes		8
8	Shelf hole plug Tapón para orificios de estantes		12
9	Snap cap Tapa a presión		4
10	Washer Arandela		4
11	Bumper Tapa a presión		2
12	Shelf glass Protector de Borde		2
13	#8*1 1/2 inch Philips head screws Tornillos Philips 1-1/2 inch, #8*		4
14	Wall anchors Anclajes para pared		4
15	Shelf clip tape Cinta para ganchos de estantes		8
16	#6*1 inch Philips head screws Tornillos Philips #6*1 inch		4
17	Recess frame (hinge side) Marco empotrado (lado de la bisagra)		1
18	Recess frame (open side) Marco empotrado (lado abierto)		1
19	Recess frame (short) Marco empotrado (corto)		2

### STEP 1 SURFACE MOUNT ONLY

1. Mounting the bottom bracket to the wall and sit the mirror cabinet on it.
2. Height of bottom bracket should be a minimum 2 inch above faucet.

### PASO 1 SOLO PARA MONTAJE EN SUPERFICIE

1. Instale el soporte inferior a la pared y coloque encima el botiquín con espejo.
2. El soporte inferior debe quedar al menos 2 inch por encima del grifo.

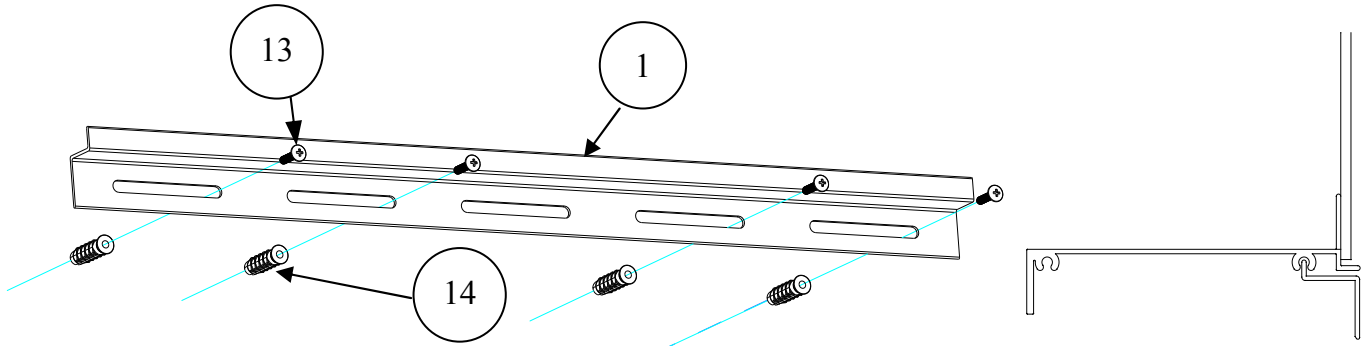

### STEP 2 SURFACE MOUNT ONLY

1. Install the top clip by inserting the rounded end into the cabinet rear top slot.
2. Slide the top clip to the left and right.
3. Using 1-1/2 inch screws through the top clip

### PASO 2 SOLO PARA MONTAJE EN SUPERFICIE

1. Instale el gancho superior insertando el extremo Redondo en la abertura superior de la parte de atras del gabinete.
2. Deslice el gancho superior hacia la izquierda y otro gancho hacia la derecha
3. Coloque dos tornillos de 1-1/2 pulgadas para fijar el gancho superior.

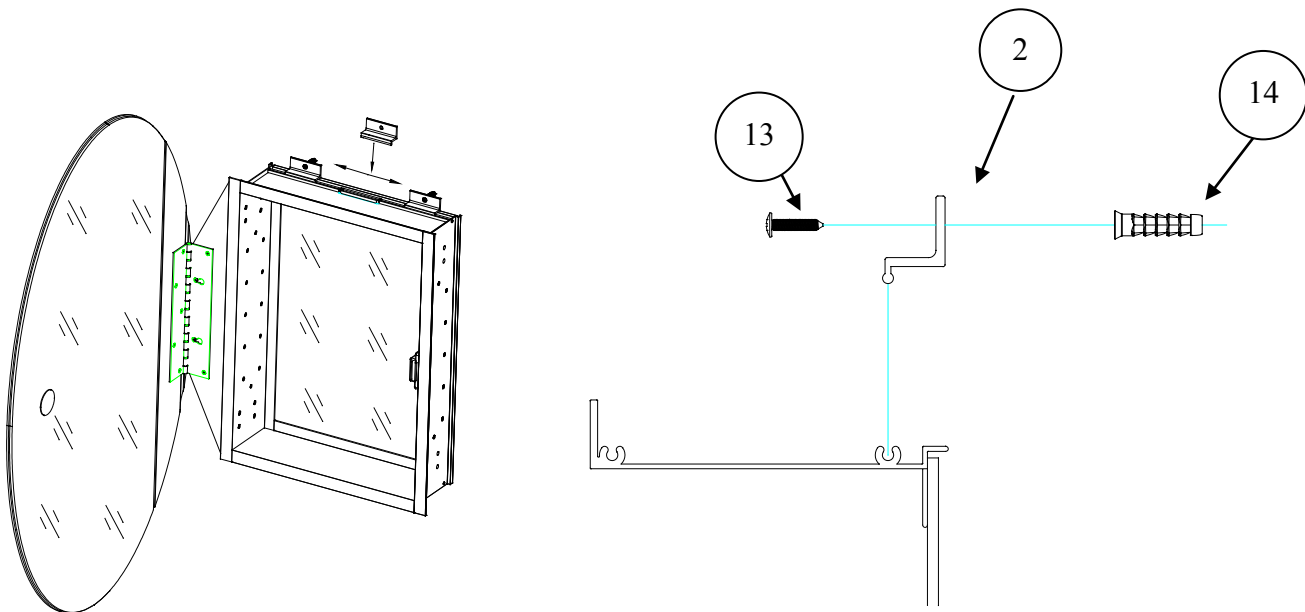

### STEP 3 SURFACE MOUNT ONLY

1. Stick side mirror bracket tape on the Side mirror bracket

### PASO 3 SOLO PARA MONTAJE EN SUPERFICIE

1. Pegue las cintas para los soportes de los espejos laterales en los lados de estos últimos.

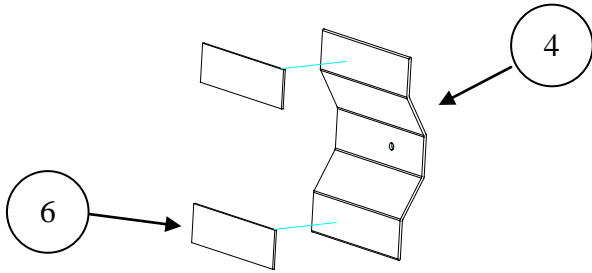

### STEP 4 SURFACE MOUNT ONLY

1. Attach the side mirror brackets with 3/8 inch screws and washers.

2. Install the snap caps to cover the screw of mounting mirror bracket.

3. Stick the side mirror to the cabinet side

### PASO 4 SOLO PARA MONTAJE EN SUPERFICIE

1. Coloque los woportes de los espejos laterals usando los tornillos y arandelas de 3/8 inch

2. Coloque las tapas a presion para cubrir el tornillo del soporte para montaje del espejo.

3. Instale el espejo lateral en uno delos lados del botiquin.

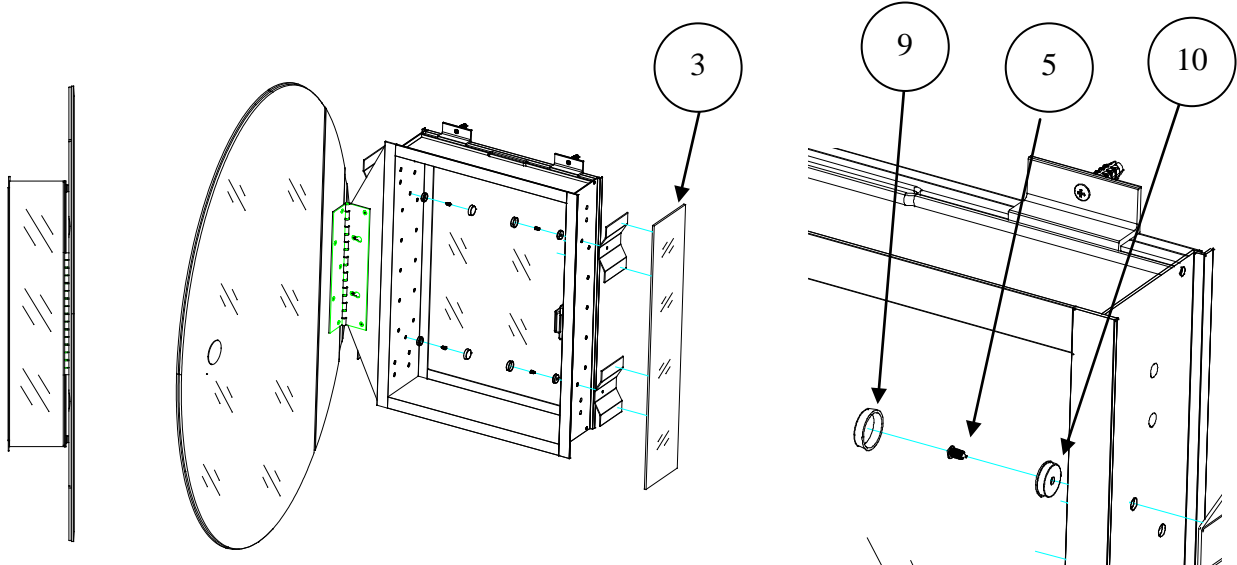

### STEP 5 RECESS MOUNT ONLY

1. Using #6\*1 inch screw assemble recess frame. As below drawing.

### PASO 5 SOLO PARA MONTAJE EMPOTRADO

1. Usar los tornillos #6\*1 inch para ensamblar el marco empotrado. Como en el siguiente bosquejo.

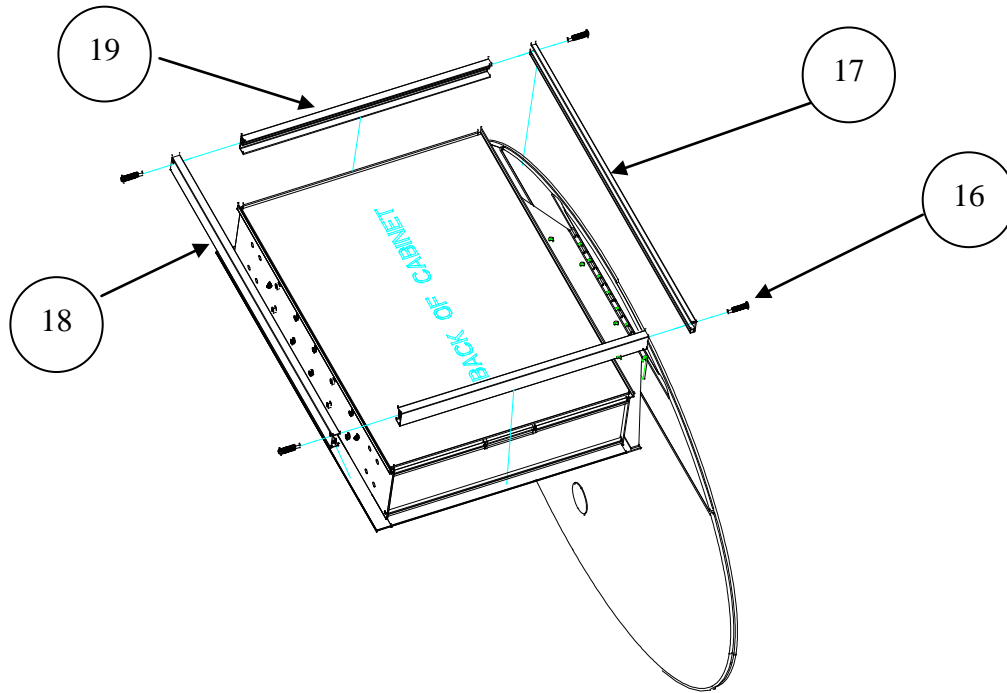

### STEP 6 RECESS MOUNT ONLY

1. Drill a 3/16 inch diameter hole at the mounting screw location. Place a Philips screwdriver in recess of the wall anchor and turn clockwise until the flange touches the wall.
2. Fasten both sides of the cabinet box using 1-1/2 inch long screws and clear washers.
3. Install the snap caps to cover the screw heads.

### PASO 6 SOLO PARA MONTAJE EMPOTRADO

1. Taladre un orificio de 3/16 inch en el lugar donde ira el tornillo de montaje. Inserte undestornillador Philllips en la abertura de la pared donde esta el anclaje y gire de izquierda a derecha toque el reborde toque la pared.
2. Apriete ambos lados de la caja del gabinete usando tornillos y arandelas transparentes de 1-1/2 inch de largo.
3. Coloque las tapas a presion para cubrirel tornillo.

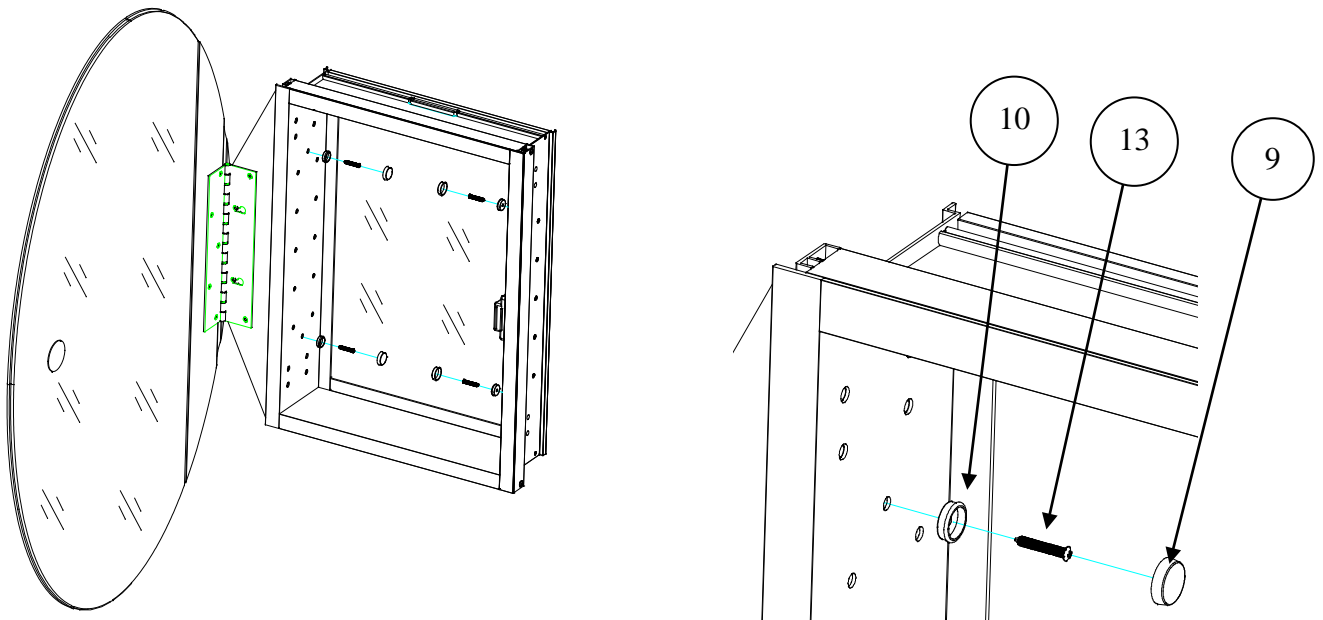



### STEP 7 SURFACE MOUNT AND RECESS MOUNT

1. Stick the tape on the shelf clip
2. Insert shelf clip into empty holes.
3. Carefully install shelf glass

### PASO 7 MONTAJE EN SUPERFICIE O EMPOTRADO

1. Pegue la cinta a los ganchos para estantes.
2. Inserte los ganchos para estantes en los orificios correspondientes.
3. Con cuidado, instale el vidrio del gabinete.

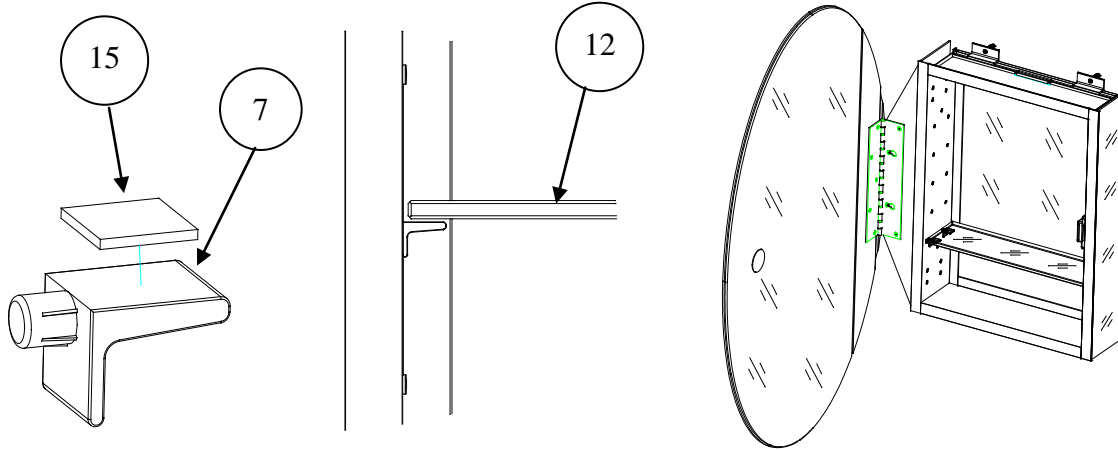

### STEP 8 SURFACE MOUNT AND RECESS MOUNT

1. Use the shelf hole plug to seal the empty hole.

### PASO 8 MONTAJE EN SUPERFICIE O EMPOTRADO

1. Selle los orificios de los estantes con los tapones correspondientes

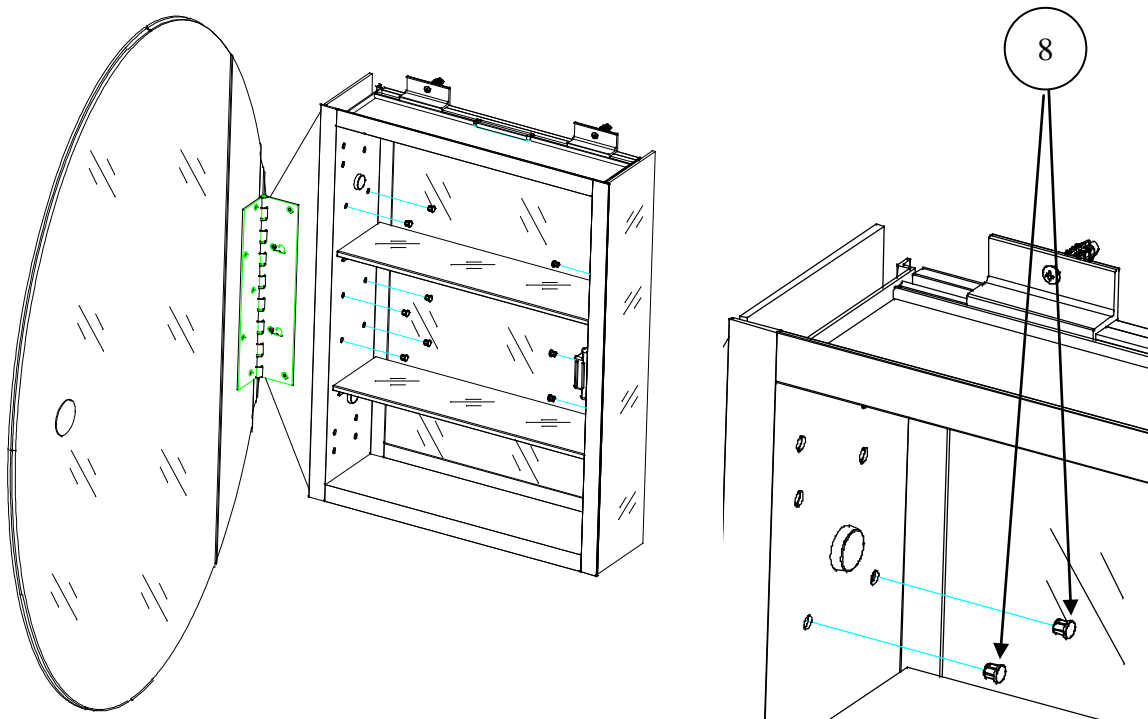

STEP 9 SURFACE MOUNT AND RECESS MOUNT

1. Stick the bumpers at 2 corner of cabinet.

PASO 9 MONTAJE EN SUPERFICIE O EMPOTRADO

1. Pegue los protectores de borde en las 2 esquinas del botiquín.

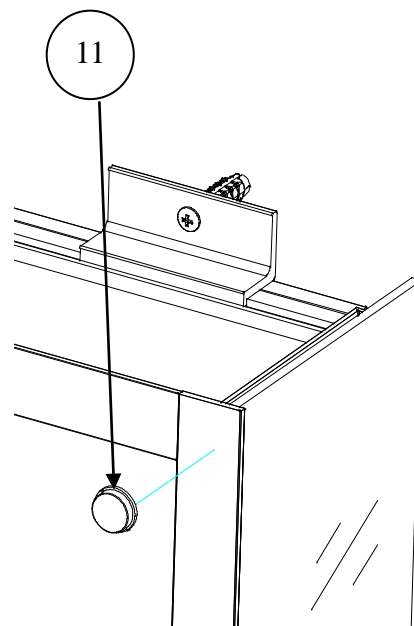
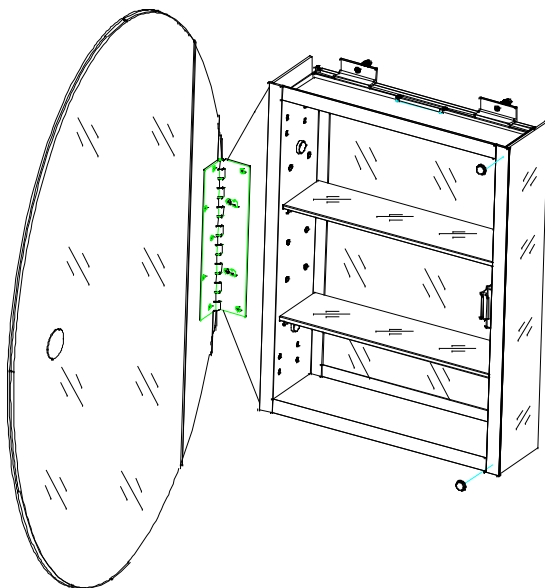

END

FIN