

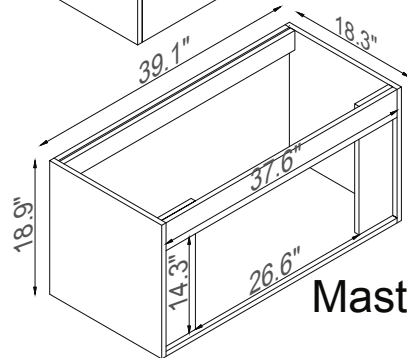

Streamline

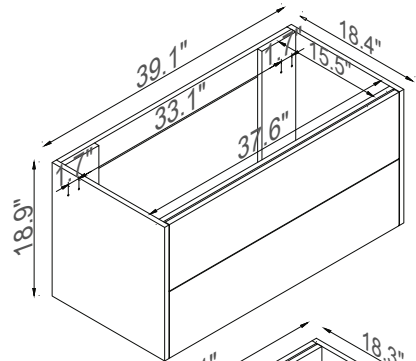
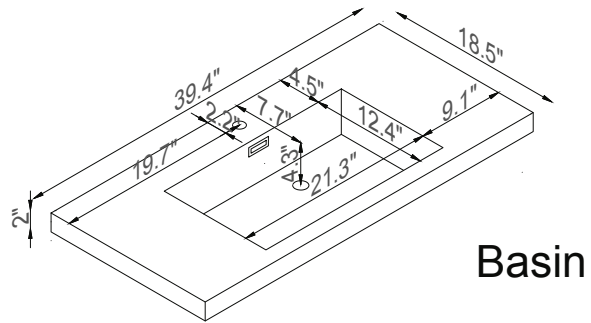
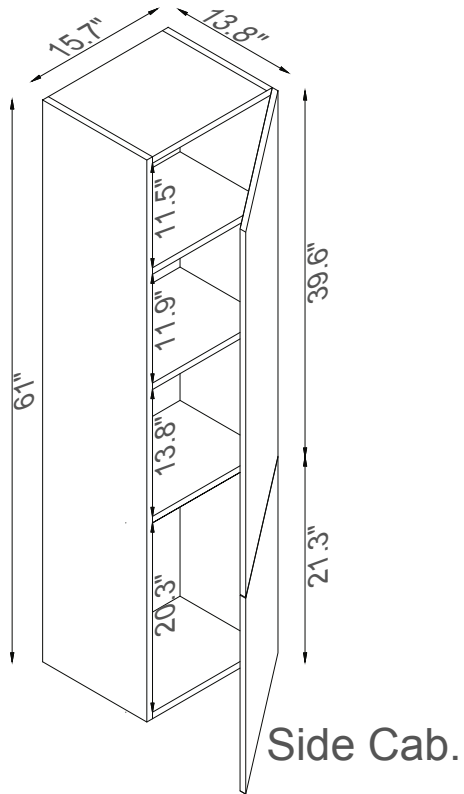

K1500-140-40-511S