

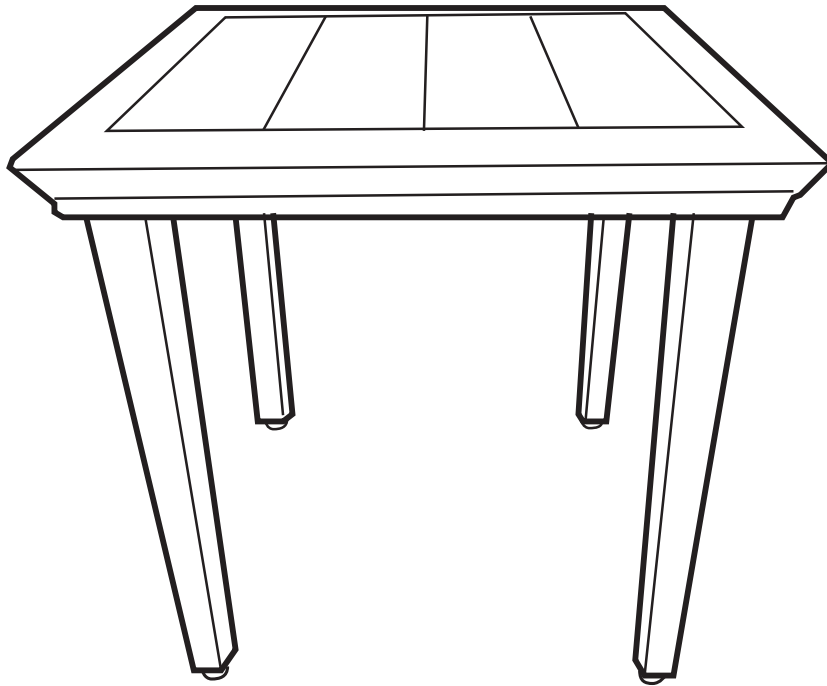

YOW sku #698 988
Model #D12237-TB

USE AND CARE GUIDE

OAK HEIGHTS BISTRO TABLE



Questions, problems, missing parts? Before returning to the store,
call Hampton Bay Customer Service
8 a.m. - 7 p.m., EST, Monday-Friday
9 a.m. - 6 p.m., EST, Saturday

1-855-HD-HAMPTON

HAMPTONBAY.COM

THANK YOU

We appreciate the trust and confidence you have placed in Hampton Bay through the purchase of this bistro table. We strive to continually create quality products designed to enhance your home. Visit us online to see our full line of products available for your home improvement needs. Thank you for choosing Hampton Bay!

Table of Contents

Table of Contents	2	Assembly	5
Safety Information	2	Care and Cleaning	6
Warranty	2		
What is Covered	2		
What is Not Covered	2		
Pre-assembly	3		
Planning Assembly	3		
Hardware Included	3		
Table Package Contents	4		

Safety Information

 **WARNING:** Do not sit or stand on the table top.

 **WARNING:** Do not place heavy items on the table top.

Warranty

THIS IS A RESIDENTIAL WARRANTY AND DOES NOT APPLY FOR COMMERCIAL USE.

2 YEAR FRAME LIMITED WARRANTY

WHAT IS COVERED

We warrant the frame to be free of manufacturing defects to the original purchaser for two years.

WHAT IS NOT COVERED

It remains the customer's responsibility for freight and packaging charges to and from our service center. This warranty does not cover commercial use, hardware, acts of nature, fire, freezing and abusive use.

In addition, purchased parts are not covered under this warranty. We reserve the right to make substitutions with similar merchandise, if the model in question is no longer in production.

For a copy of our full limited warranty, please contact our customer service team below.

Contact the Customer Service Team at 1-855-HD-HAMPTON or visit www.hamptonbay.com.

Pre-assembly

PLANNING ASSEMBLY

please read complete instruction manual prior to assembly!

Identify all parts packed in the carton against the parts list. Remove all protective materials and place the parts on a nonabrasive surface to avoid scratching.



NOTE: More than one person may be required to complete the assembly of this product.

HARDWARE INCLUDED



NOTE: Tools not shown to actual size.

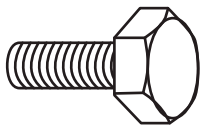

_____ AA



_____ BB

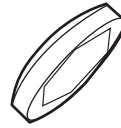

_____ CC

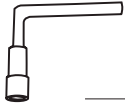

_____ DD

Part	Description	Quantity
AA	M6*15 Hex bolt	12
BB	M6 Washer	12
CC	M6 Hex bolt cap	12
DD	Wrench	1

Pre-assembly (continued)

TABLE PACKAGE CONTENTS

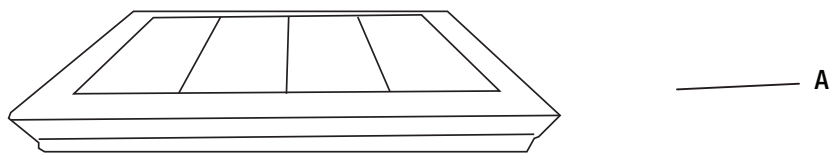

Part	Description	Quantity
A	Table top	1
B	table legs	4

1 Attaching the table legs

- Place the table top (A) on a soft, flat non-abrasive surface.
- Attach the table legs (B) to the table top (A) using washers (BB) and hex bolts (AA).
- Ensure all the bolts are aligned and assembled correctly.
- Tighten all the hex bolts (AA) using wrench (DD).
Attach all the hex bolts caps (CC).

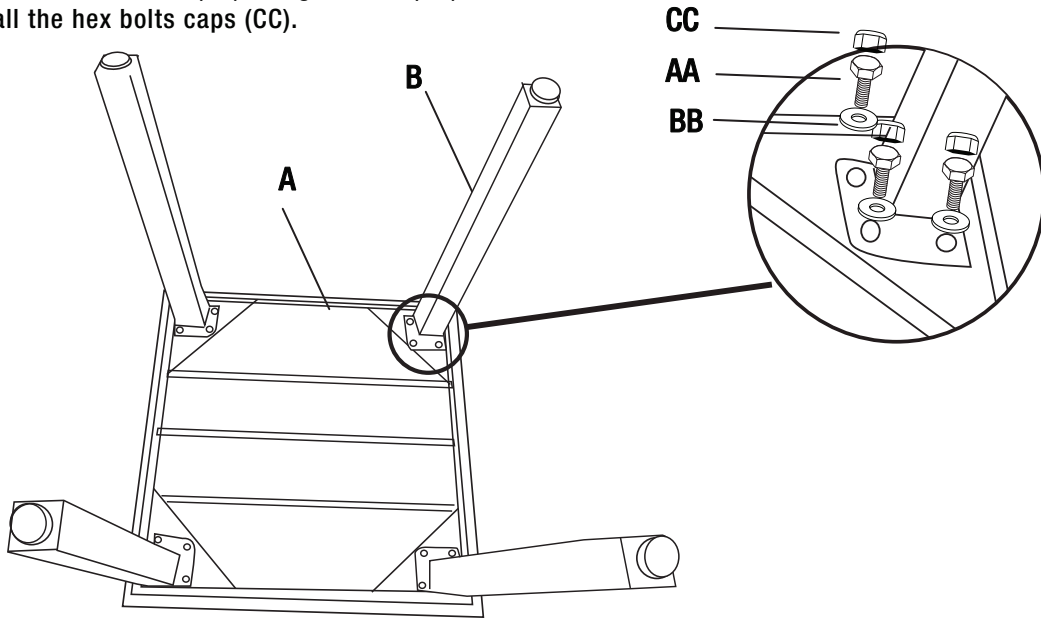

2 Positioning the table

- Turn the table over and set it down on its legs.
- The table is now ready for use.

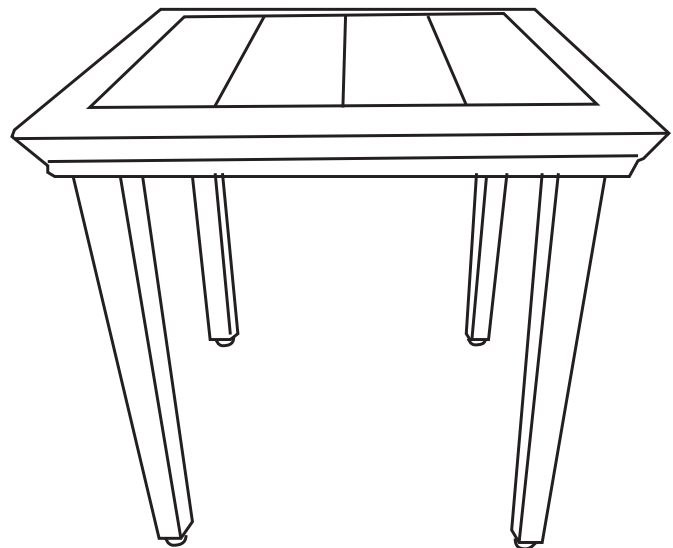

Care and Cleaning

- Do not allow water to build up in frames. This will cause corrosion and possible freezing damage in cold climates.
- Use a mild soap and water for normal cleaning. DO NOT use janitorial or alcohol based cleaners. Some cleaners may be marked as natural, but some ingredients may cause discoloration or have an adverse reaction to your finish.
- Rinse with clean water and dry with a soft, absorbent cloth towel.
- Treat frames with a liquid wax for maximum protection against UV rays and/or salty, damp air.



Questions, problems, missing parts? Before returning to the store,
call Hampton Bay Customer Service
8 a.m. - 7 p.m., EST, Monday-Friday
9 a.m. - 6 p.m., EST, Saturday

1-855-HD-HAMPTON

HAMPTONBAY.COM

Retain this manual for future use.