

Features

- Two-piece toilet.
- Elongated bowl offers added room and comfort.
- Skirted trapway simplifies cleaning.
- ContinuousClean system automatically dispenses cleaning solution with every flush.
- Works with any toilet bowl cleaner tablets. Tablets last for more than one year in ContinuousClean system.
- Revolution 360 swirl flushing technology generates a forceful swirling motion to keep the bowl cleaner, longer.
- Comfort Height feature offers chair-height seating that makes sitting down and standing up easier for most adults.
- 1.28 gallons per flush (gpf).
- Standard left-hand Polished Chrome trip lever included.
- 2-1/8-inch fully glazed trapway.
- Patented ReadyLock™ installation system is a simple solution for skirted toilets that saves time, hassle, and eliminates the need to drill into the floor for a standard 12-inch rough-in.
- CleanCoat™ technology inhibits the growth of water scale and mineral stains for improved ease of cleaning.
- Combination consists of the K-4144 bowl and K-5711 tank.

Technology

- Adjustment dial lets you set how much cleaning solution is dispensed with each flush.
- Optional: uses two AAA batteries (included) to power the LED system indicator light. System indicator light will notify user when system working properly and when to replace cleaning agent or batteries.
- Single-flush gravity uses the force of gravity and a precision-engineered tank, bowl, and trapway to create a strong siphon during flushing.
- AquaPiston® canister allows water to flow out of the tank from all sides (360 degrees), increasing the power and effectiveness of the flush.
- Flush valve's 3:2 ratio harnesses the natural force of gravity and optimizes flush performance.
- Durable canister design has 90% less exposed seal material than a 3-inch flapper, for leak-free performance. Light-touch canister flush requires a lower actuation force than a flapper.

Installation

- Standard 12-inch rough-in.
- 10-inch and 14-inch rough-in kits are also available.
- Seat and supply line not included.

Water Conservation & Rebates

- WaterSense® toilets meet strict EPA flushing guidelines, including using at least 20 percent less water than 1.6-gallon toilets.



ADA CSA B651 OBC

Codes/Standards







ASME A112.19.2/CSA B45.1
DOE - Energy Policy Act 1992
EPA WaterSense®
California Energy Commission (CEC)
ADA
ICC/ANSI A117.1
CSA B651
OBC

KOHLER® One-Year Limited Warranty

See website for detailed warranty information.

Available Color/Finishes

Color tiles intended for reference only.

Color	Code	Description
	0	White
	96	Biscuit
	NY	Dune
	95	Ice™ Grey
	G9	Sandbar
	7	Black Black™

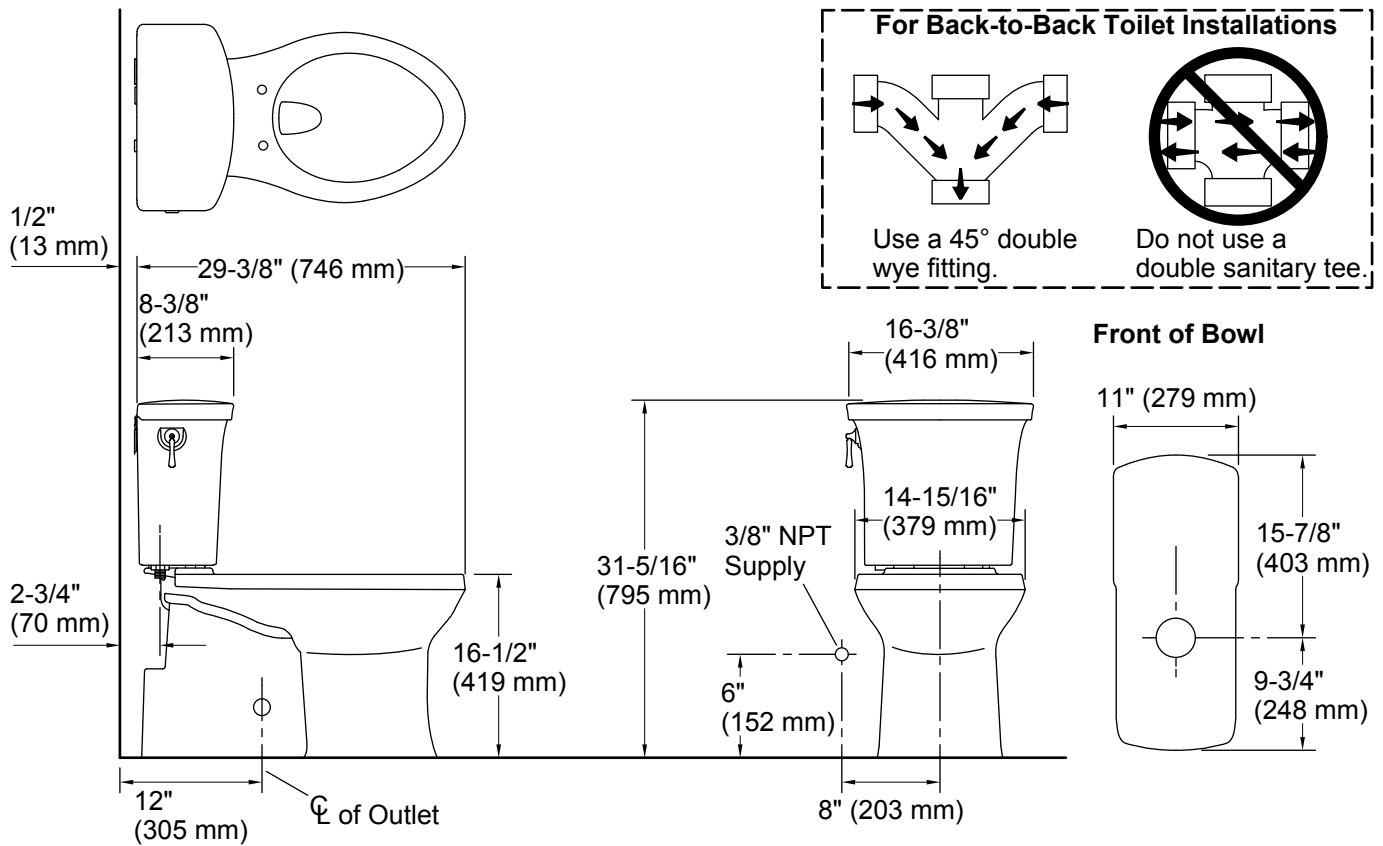

Technical Information

All product dimensions are nominal.

Toilet type:	Two-piece, Floor-mount
Waste Outlet:	Floor
Bowl shape:	Elongated front
Flush type:	Siphon jet
Rough-in:	12

Notes

Install this product according to the installation instructions.

For back-to-back toilet installations: Use only a 45° double wye fitting.

ADA, OBC, CSA B651 compliant when installed to the specific requirements of these regulations.

Plumbing codes may require elongated toilets and elongated, open-front seats in public bathrooms.

Accessibility standards may require controls to be located on the open side of the toilet.