



9x6 Cabana - Bevel Assembly Manual

Thank you for purchasing a 9x6 Cabana. Please take the time to identify all the parts prior to assembly.

Note: The General Assembly Manual illustrates a Door Configuration in the front center location. The Door can also be positioned in the front corners. To correctly configure Door in front corners, follow general assembly steps and refer to Page 25 for required changes.

Safety Points and Other Considerations

Our products are built for use based on proper installation and normal residential use, on level ground. Please follow the instruction manual when building your shed and retain the manual for future maintenance purposes.

Some of the safety and usage measures you may wish to consider include:

- snow load ratings vary by geographical location. If heavy or wet snowfall occurs, it is advisable to sweep the snow off the roof(s).
- if the product is elevated, any structural and building code requirements are solely the customer's responsibility, and should be abided by.
- in high or gusty wind conditions it is advisable to keep the structure securely grounded.
- have a regular maintenance plan to ensure screws, doors, windows and parts are tight.

Customer agrees to hold Outdoor Living Today Partnership and any Authorized Dealers free of any liability for improper installation, maintenance and repair.

In the event of a missing or broken piece, simply call the Outdoor Living Today Customer Support Line @ 1-888-658-1658 within 30 days of the delivery of your purchase. It is our commitment to you to courier replacement parts, free of charge, within 10 business days of this notification. Replacement parts will not be provided free of charge after the 30 day grace period.



**Thank you for purchasing our 9x6 Cabana.
Please take the time to identify all the parts prior to assembly.**

Parts List:

A. Floor Section

- 3 - 35" x 75" - Floor Joist Frames
- 2 - 48" x 75" - Plywood Floor - Large
- 1 - 9" x 75" - Plywood Floor - Small
- 4 - 1 1/2" x 3 1/2" x 72" - Floor Joists
- 3 - 1 1/2" x 3 1/2" x 57" - Floor Runners - Long
- 3 - 1 1/2" x 3 1/2" x 48" - Floor Runners - Short

B. Wall Section

Main Wall Panels

- 7 - 35" w x 75" h Solid Wall Panels (7 walls with Bottom Plates Unattached)
- 7 - 1 1/2" x 2 1/2" x 35" Bottom Wall Plates
- 2 - 35" x 75" Window Wall Panels

Door Jambs & Header

- 2 - 1 1/2" x 3 1/8" x 73" - Vertical Door Jambs
- 1 - 2" x 3 1/8" x 35" - Door Header (Dado cut on edge)

Gable Walls

- 2 - Side Gable Walls - Triangular shaped

Top Wall Plates

- 4 - 3/4" x 2 1/2" x 50" - Front & Rear Top Wall Plate - Angle cut on edge
- 2 - 3/4" x 2 1/2" x 75" - Side Top Wall Plate - Angle cut on ends

C. Rafter and Roof Section

- 18 - 1 1/2" x 3 1/2" x 45" - Rafters (angle cut)
- 2 - 3/4" x 4 1/2" x 44" - Ridge Boards
- 2 - 3/4" x 4 1/2" x 61" - Ridge Boards
- 4 - 1/2" x 4 1/2" x 52 1/2" Soffits (Front and Rear)

Roof Panels

- 4 - Outside Roof Panels 41" (Shingles overhanging roof battens on 1 end)
- 2 - Middle Roof Panel 35" (Shingles flush with roof battens)
- 3 - 3/4" x 3 1/2" x 48" Roof Gussets (angle cut on ends)
- 4 - 3/4" x 2 1/2" x 36" Facia/Roof Nailing Strips

D. Miscellaneous Section

Bottom Skirting

- 10 - 1/2" x 4 1/2" x 34 3/4" Bevel Bottom Skirting

Corner & Wall Trim

- 4 - 1/2" x 4 1/4" x 82" - Wide Corner Trims
- 8 - 1/2" x 2 1/2" x 79" - Narrow Trims
- 2 - 1/2" x 2 1/2" x 77 1/2" Side Wall Narrow Trims
- 8 - 5/8" x 2 1/2" x 36" - Filler Trims
- 4 - 1/2" x 4 1/2" x 33 3/4" - Horizontal Gable Trims

Facia Trim

- 4 - 3/4" x 3 1/2" x 46" - Side Facia - Angle cut both ends
- 4 - 3/4" x 3 1/2" x 57 1/4" - Front & Rear Facia- square cut
- 2 - 1/2" x 3 1/2" x 8" - Facia Detail Plate Pieces (front and rear)
- 2 - 1/2" x 4 1/2" x 8" - Horizontal Gable Trim Detail Plates
- 2 - 1/2" x 5 1/2" x 8" - Pentagon Facia Plates- (sides)

Filler Shingles

- 12 pcs - Long
- 4 pcs - Short

Door

- 1 - 31 1/2" x 42" - Bottom Dutch Door Section
- 1 - 31 1/2" x 30" - Top Dutch Door Section
- 1 - 1/2" x 1 1/4" x 32" - Horizontal Door Trim
- 2 - 1/2" x 2 1/2" x 72" Interior Vertical Door Stops
- 1 - 1/2" x 2 1/2" x 36" - Interior Top Horizontal Door Stop

Ridge Caps

- 1 Bundle Cedar Shingle Roof Ridge Caps - 18 pcs

****Miscellaneous Pieces**

- 1 pc - Spare Wall Siding
- 2 - Window Inserts
- 2 - Window Trim Pkg - (1-24 1/16" angle cut / 3 -23" square cut)
- 2 pcs - Shim Shingles- use to shim door, etc
- 2 - Flower Box Kits

Note: All Trim, Facia and Bottom Skirting pieces will be positioned rough face out when installed.

9X6 CABANA HARDWARE PACKAGE

Hardware Kit (Provided) Note: screws and nails shown actual size.

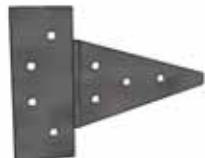
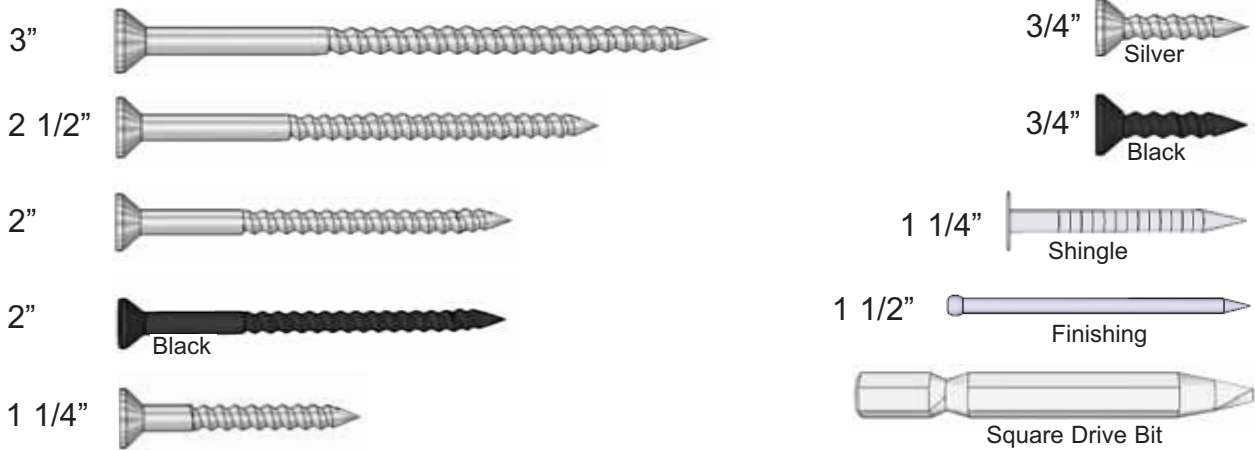

Tee Hinge x4



Door Handle



Barrel Bolt



Simpson Strong Tie (Roof) x 8



Silver Barrel Bolt



Ridge Board Connector x 2

Tools Required (Not Provided)



Hammer



Screw Gun/Drill



Tape Measure



Wood Clamp



Level



Pliers



Ladder



1/8" & 3/8" Drill Bits

Safety Equipment Required (Not Provided)



Safety Glasses



Work Gloves

A. Floor Section

Exploded view of all parts necessary to complete Floor Section. Identify all parts prior to starting.

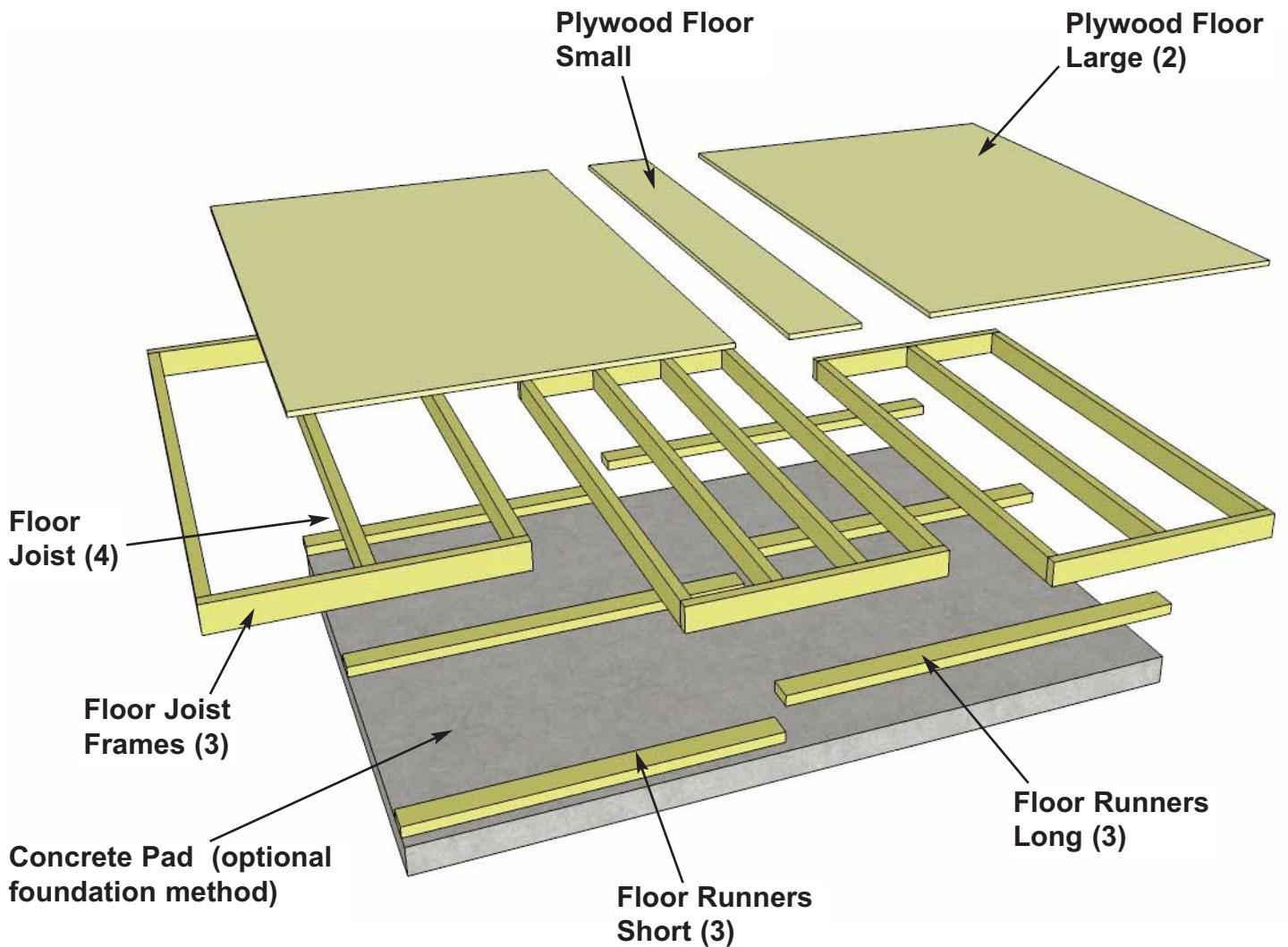

You can find the Square Drive Bit for the screws in with the Hardware Kit Bag.

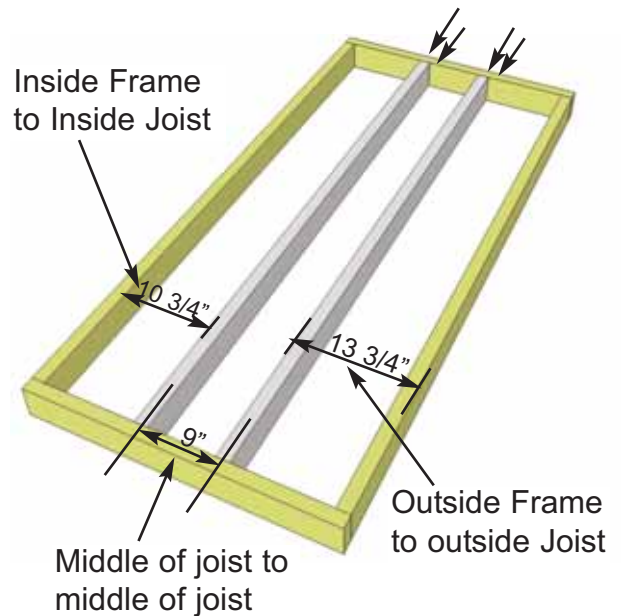

1. Attach Interior **Floor Joists** (4) (1 1/2" x 3 1/2" x 72") to **Floor Joist Frames**. Only the Center Floor Joist Frame requires 2 Joists to be attached. Measure and attach both Joists with 2 - 2 1/2" screws per joist end as illustrated to the right.

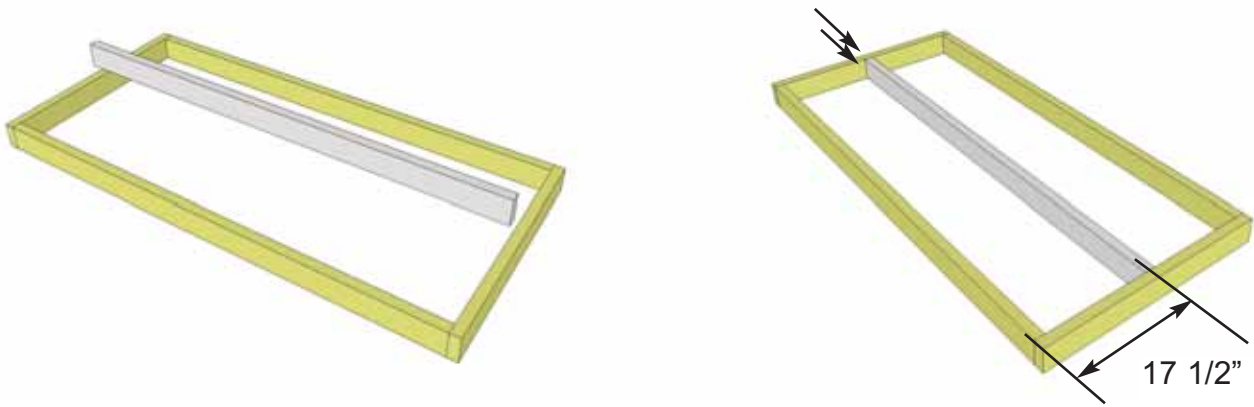

2. Both Outside **Floor Joist Frames** require 1 Joist attachment. Center Joist 17 1/2" from Outside of Floor Joist Frame and attach with 2 - 2 1/2" screws per end.

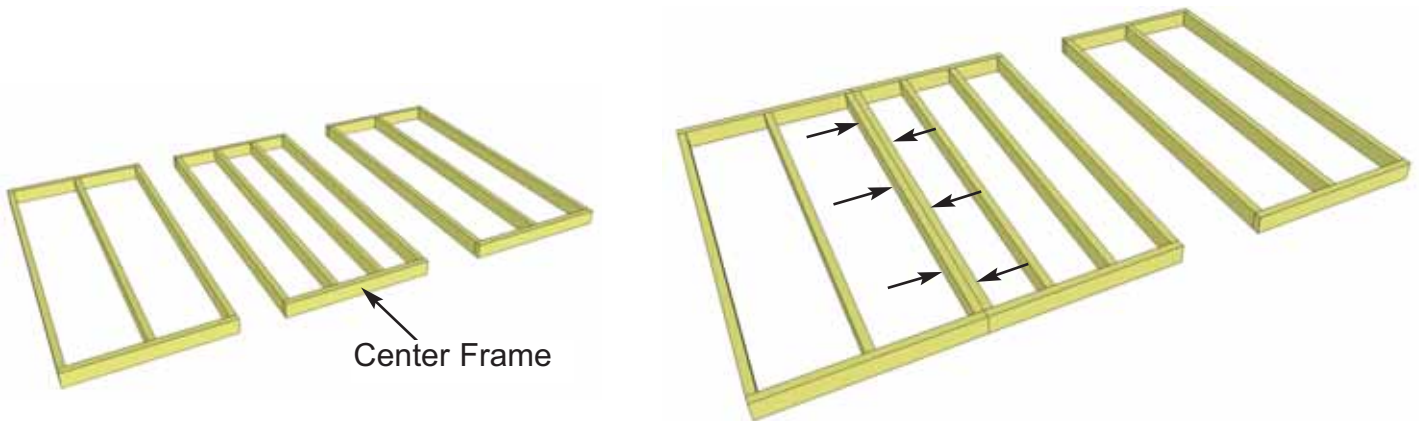

3. Position completed Floor Joist Frames with center frame in the middle. Attach the floor joist frames together with 6 - 2 1/2" screws per section. When completed, your floor joist section should be **105" wide x 75" deep**.

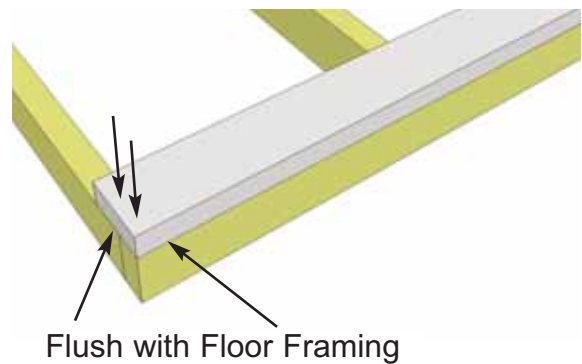
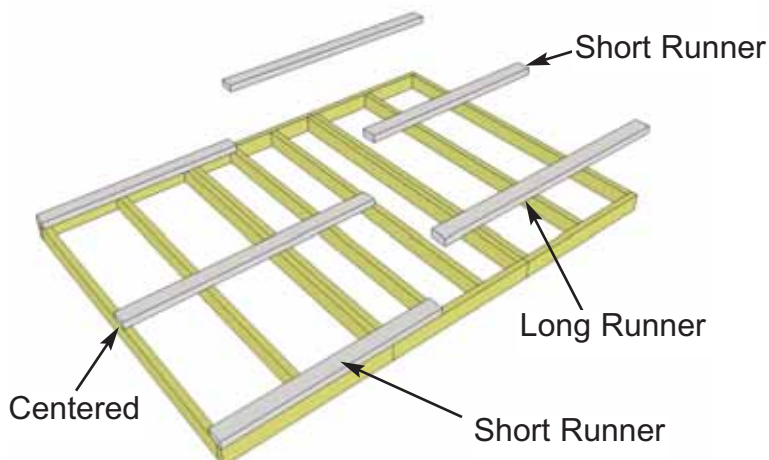
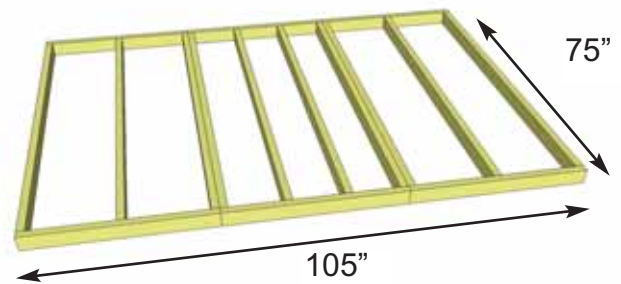

4. Attach **Floor Runners** to completed floor frame. There are 2 floor runners per 105" side and 3 completed Runners in total. Each completed Runner will have a long and short piece. Use 10 - 2 1/2" screws to secure long Runners and 8 - 2 1/2" screws to secure short Runners. Reverse long and short position of centre Runner to provide more floor strength.



Concrete Slab Foundation

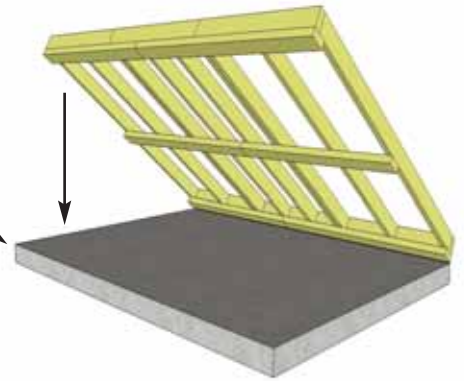

5. With Floor Runners attached, carefully flip the floor over and place on your foundation. **Caution:** you will need 2 people to assist you. Be careful when laying floor down not to bend or twist floor. When in place, level floor completely.

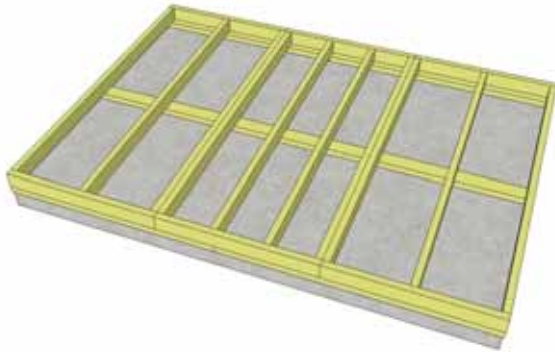

Foundations

Note: The floor will be flipped over and floor runners will sit on your foundation. It is important to note that having a level foundation is critical. Choosing a foundation will vary between regions. Typical foundations can be concrete pads or patio stones positioned underneath the floor runners.

6. Position **Plywood Floor** pieces (3) on top of completed Floor Joists. Plywood will sit slightly back from outside edge of Floor Joist Framing. When in correct position, attach with 1 1/4" screws. Use screws every 16". The Plywood is cut slightly smaller than floor framing. Keep plywood seams tight.

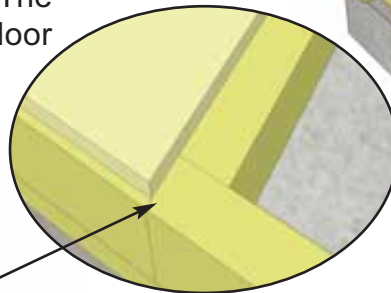
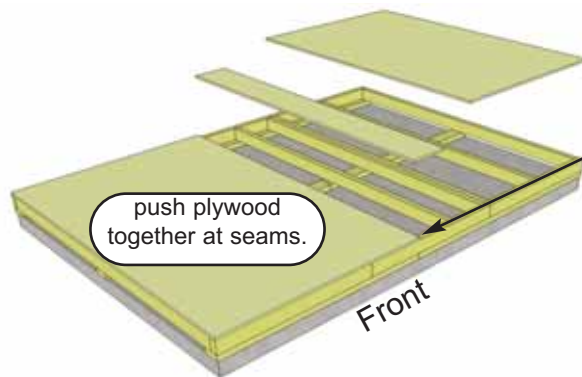
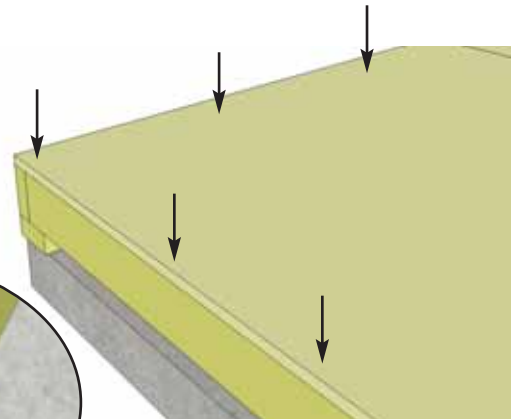

Hint: Use a chalk line to mark location of floor joists to determine screw placement.

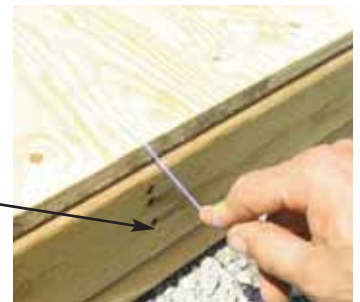

7. When completed, make sure the floor is still level and make adjustments if required. When completed, your floor should look similar to this.

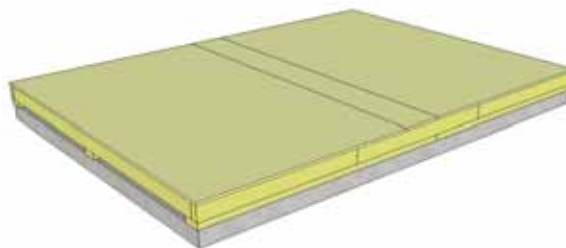

Important - Make sure floor is level before moving on to wall section. Use a level to confirm, and shim floor joists as required.

B. Wall Section

Exploded view of all parts necessary to complete the Wall Section. Identify all parts prior to starting.

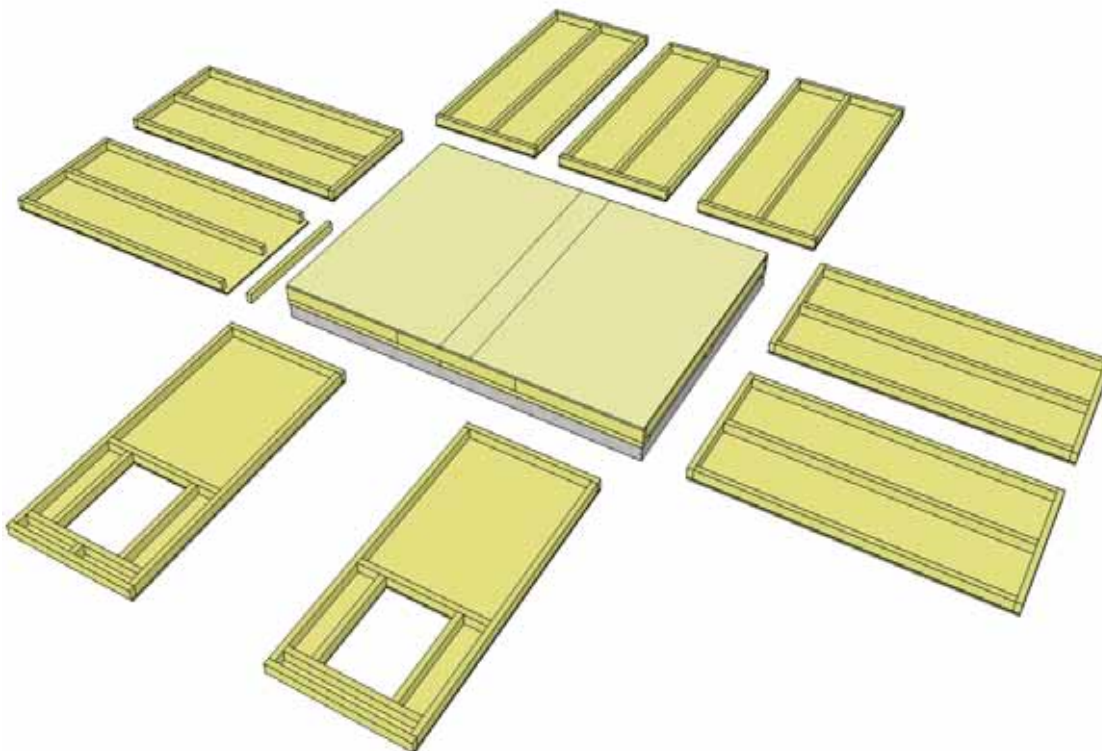
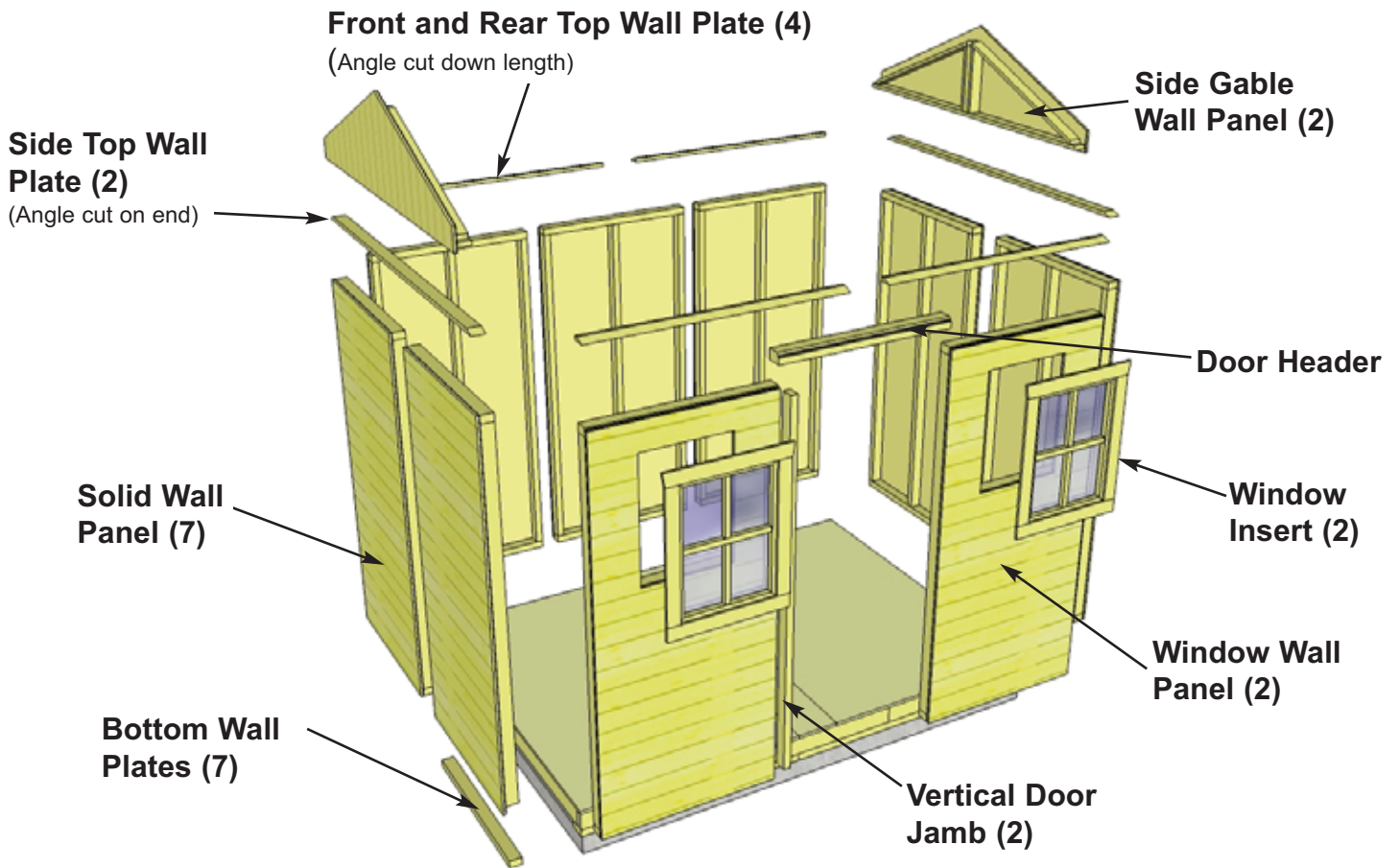

8. Lay out all the wall panels and become familiar with their location. On Standard Kits, there are **2 Window Wall Panels** and **7 Solid Wall Panels**. Make sure panels are in upright position so water is directed away from and not into shed. Compare siding of solid panels with window wall panels to determine if in upright position.

Important:
Pilot hole ALL 2x3 Wall Studs with 1/8" drill bit prior to screwing. This will make it much easier to attached together.

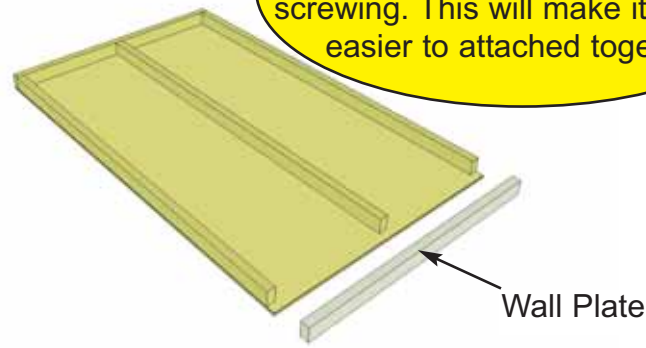

Pilot Hole first.

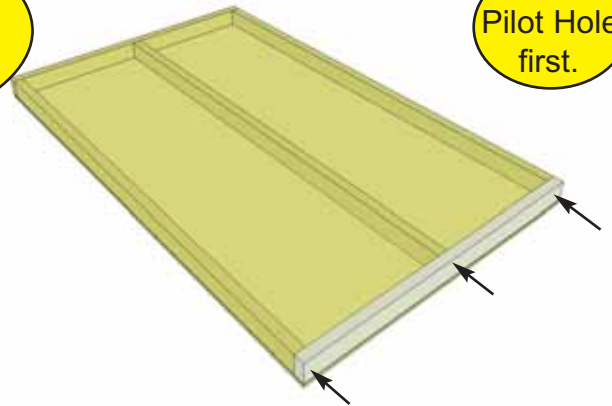

9. Starting with **Solid Wall Panels**, carefully lay panel face down. Position and attach **Wall Plate** to bottom of wall studs of each wall panel with 3 - 2 1/2" screws. Position so plates are flush with framing.

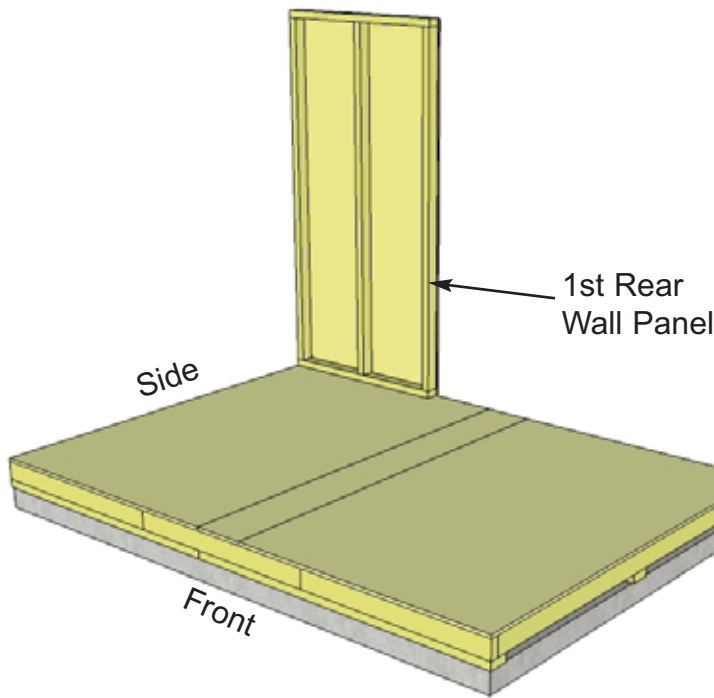

10. Starting at Rear Corner, position a Solid Wall Panel on top of plywood floor. Depending on your preference, you may use a solid or window wall panel in this position. If using a solid wall, make sure panel is facing up.

Important - Make sure all walls are aligned in their upright position. If not, water may leak into your shed. Unsure if panel is facing up or down? Compare solid wall siding to window wall siding and match orientation.

11. The Front and Rear Wall Panels will sandwich the Side Panels. **Note:** 2x3 wall frame will sit flush with floor frame, siding will overhang the floor horizontally by approximately 1/2".

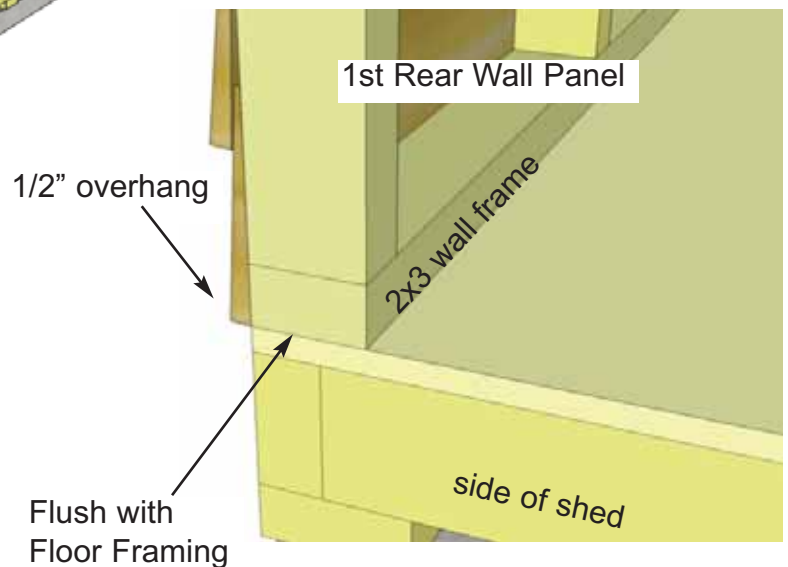

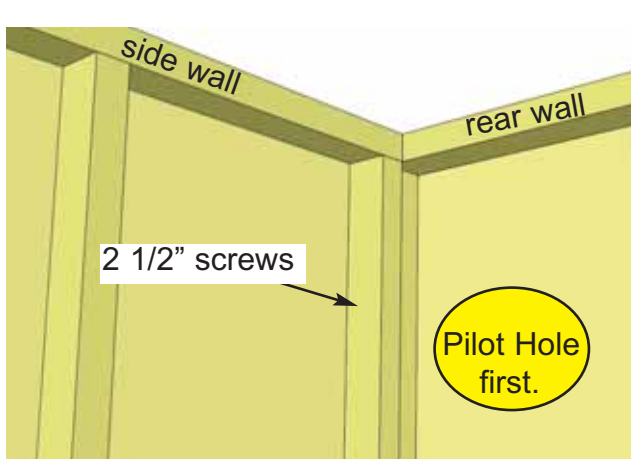

Optional - Caulking seams will help prevent moisture from entering your shed. **Caulking not included in kit.**

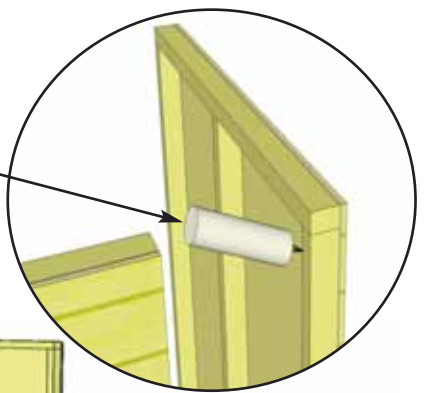

12. Position 1st side wall panel on plywood floor so once again 2x3 bottom wall plate is sitting flush with floor framing. Position panel so vertical 2x3 framing sits flush with rear wall framing. When both wall panels are positioned correctly, attach together at top, middle and bottom of vertical studs with 2 1/2" screws.

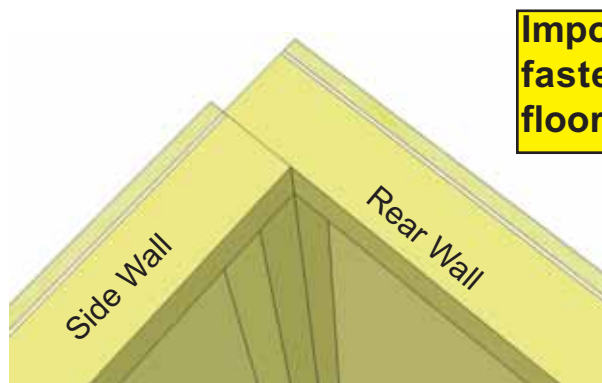
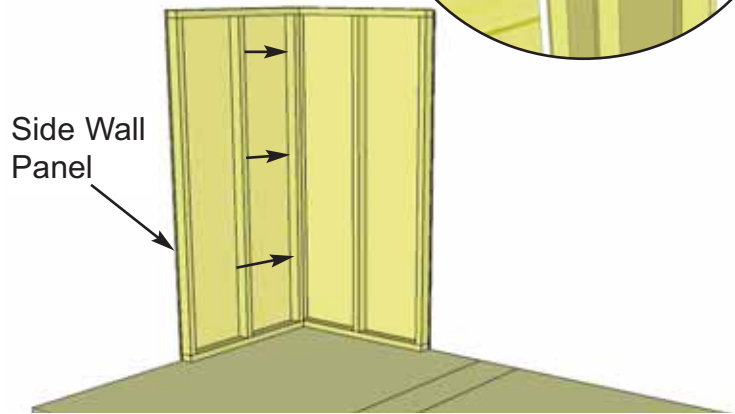

Important - Do not fasten walls to floor until Step 21.

13. When correctly aligned, looking from the top view, 2x3 wall framing of corner wall panels will be positioned as illustrated above.

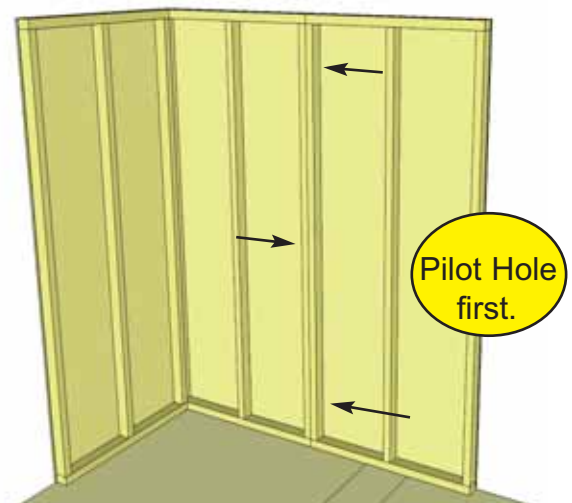

14. Position and attach 2nd rear wall panel as shown above. Attach adjacent wall studs together with 3 - 2 1/2" screws.

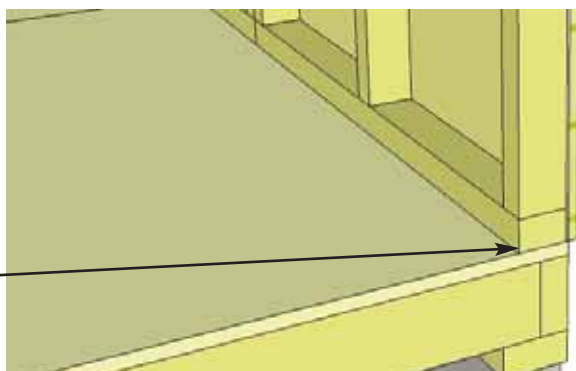
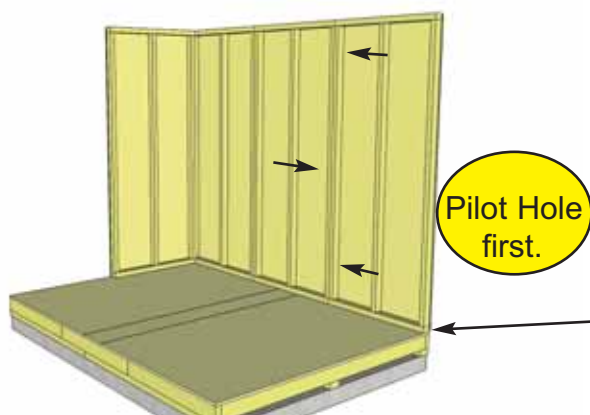

15. Position and attach 3rd rear wall panel and attach as per **Step 14**. **Note:** wall framing of 3rd rear wall should sit flush with floor framing.

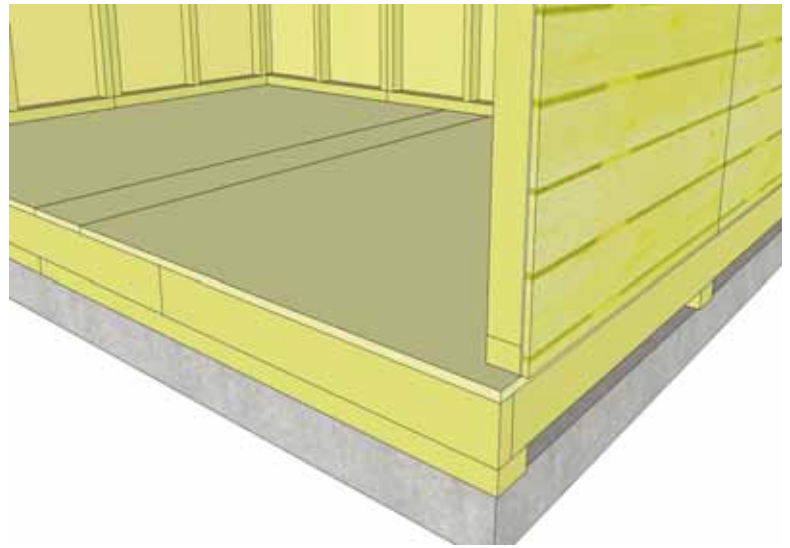
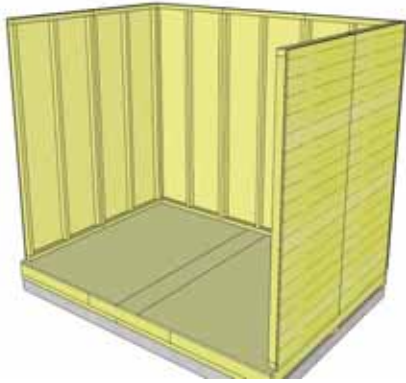

16. Complete attachments of remaining side walls as per **Steps 11-15**.

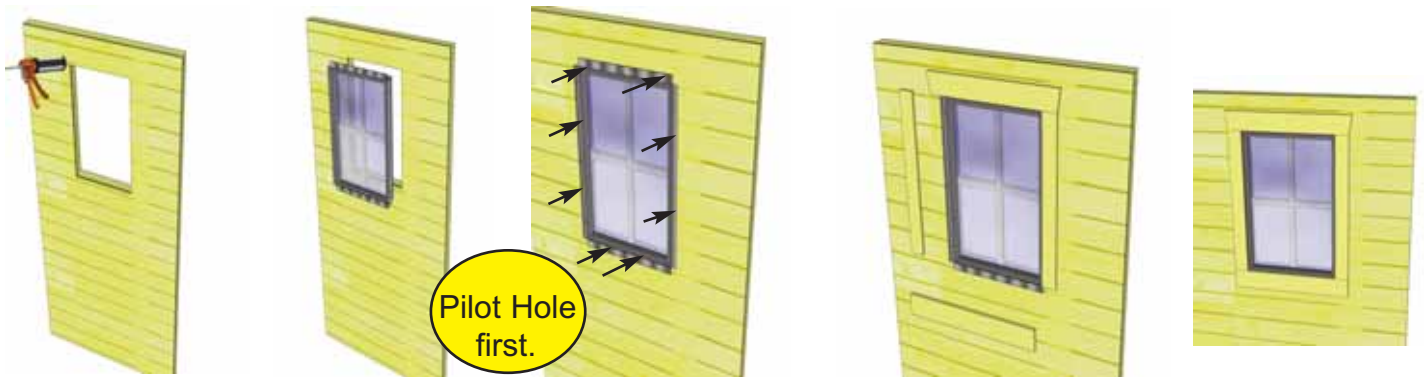

17. Locate **Window Inserts** and **Window Trim Packages**. Before installing, run a bead of caulking around window opening perimeter. Position window in cavity and secure with 8 - 1 1/4" screws. Position Window Trim around window doing a dry run first and attach with 4 - 1 1/2" finishing nails per piece. **Trim Sizes = 1x 24 1/16" = top / 3 x 23" = Sides & Bottom.**

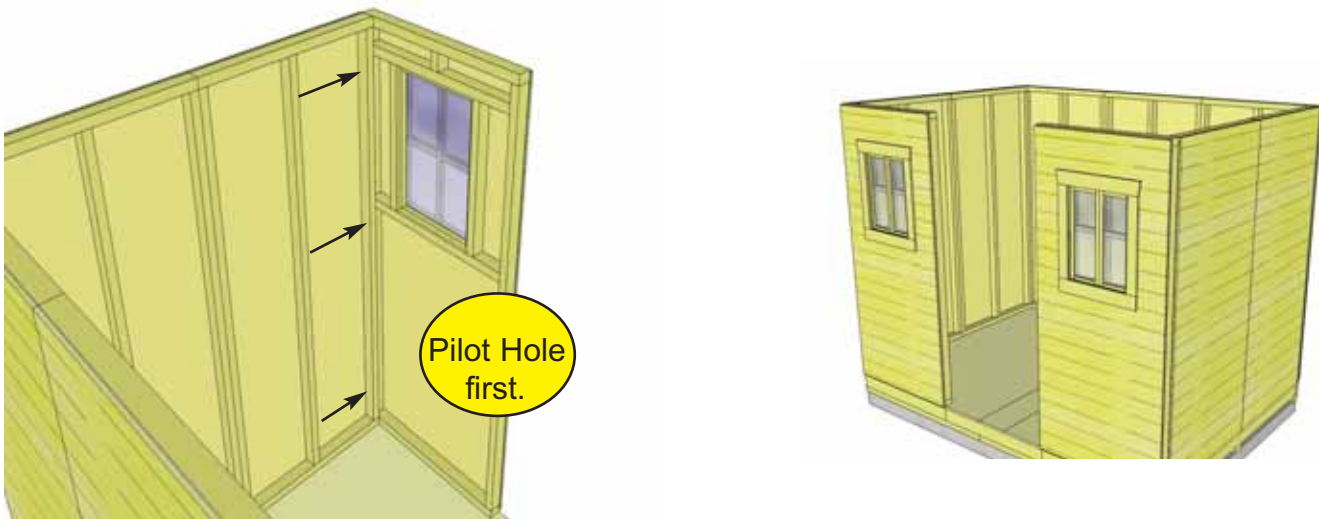

18. Position and attach both Window Walls as per **Steps 11-15**.

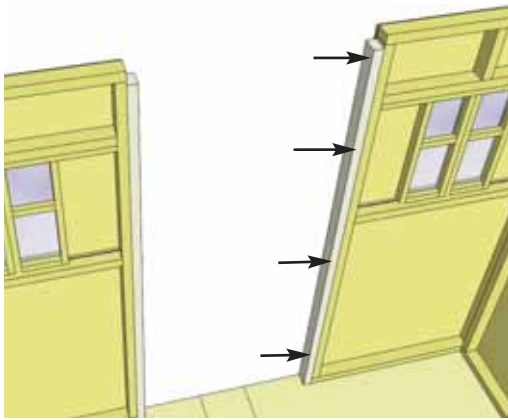

19. Attach both **Vertical Door Jambs** (1 1/2" x 3 1/8" x 73") to door opening wall studs with 4 - 2 1/2" screws per Jamb. Position so jamb is flush with outside wall paneling.

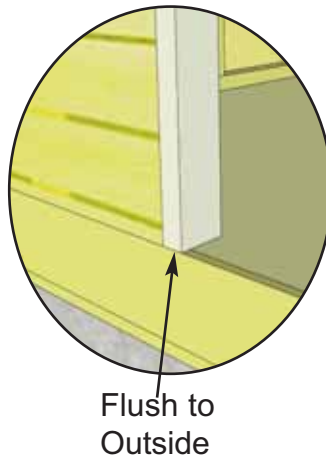

Flush to Outside

Step or dado edge to front and on top.

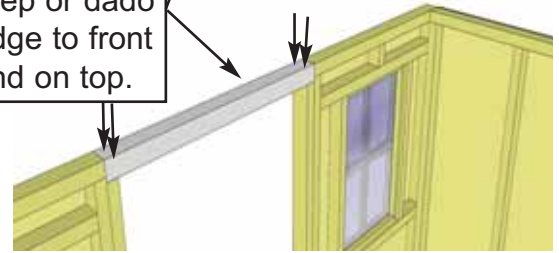

20. Attach **Door Header** (2" x 3 1/8" x 35") to vertical door jambs with 2 - 2 1/2" screws per side. Header is 3" wide at bottom and has a 1/2" thick x 2 1/2" wide strip of wood stapled to the top creating a step or dado effect. This step needs to be positioned on the top facing the front. The step is necessary as the roof panel may hang up on the header and must sit flush on the rafter tops when attached. **Screw from door header into door jambs with 4 - 2 1/2" screws (2 per side). Pre-drill to prevent splitting!**

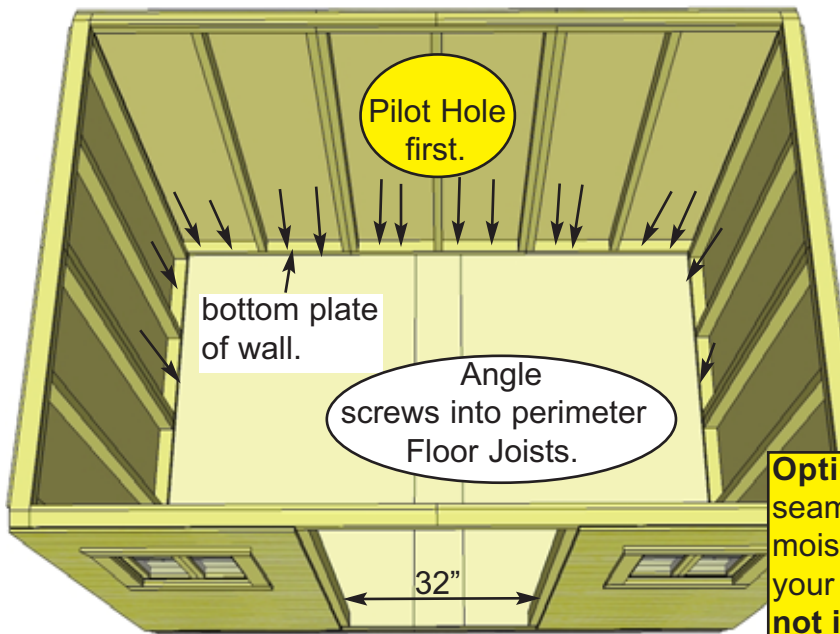

21. When all walls are attached together, check alignment with the floor. Bottom of wall frames should sit flush with outside of floor framing, with siding overhanging by approximately 1/2". Confirm 32" wide door opening at bottom. When positioned correctly, fasten bottom wall plates to floor using 4 - 2 1/2" screws per wall panel.

Optional - Caulking seams will help prevent moisture from entering your shed. **Caulking not included in kit.**

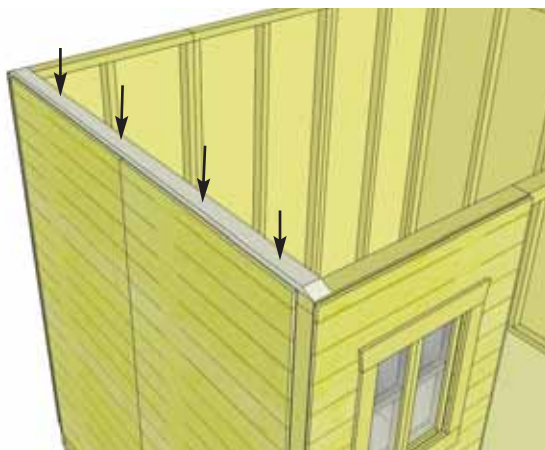
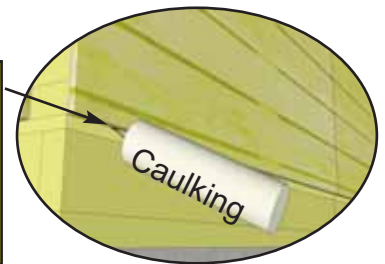

22. Position a **Side Top Plate** (3/4" x 2 1/2" x 75" angle cut on end) on top wall framing so they are flush. Attach by screwing down into top of wall frame with 4 - 2" screws.

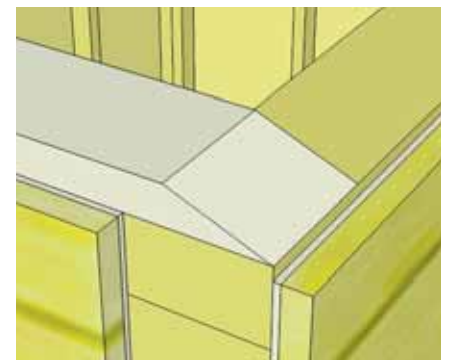

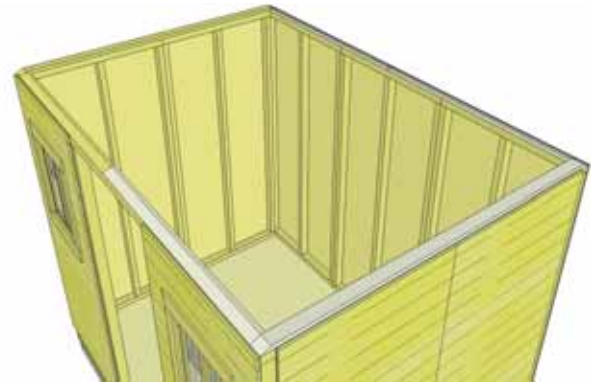
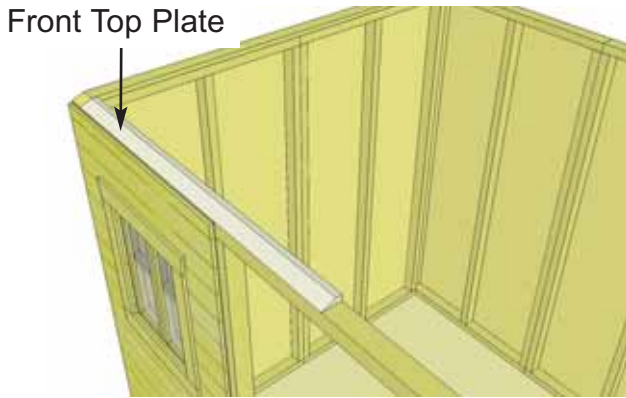

23. Next, attach the **Front Top Plates** (2), (3/4" x 2 1/2" x 50"). The front and rear top plates are angle cut down the length. Once again, position top plates on wall frame so they are flush. Front and rear top plates will fit between side top plates. Attach with 4 - 2" screws per plate. Complete all other Top Plate attachments - side and rear.

24. Place **Side Gable Wall** so 1x3 framing sits flush with the inside of the top plate. It should also be centered sideways on the top plate. Adjust gable accordingly. Temporarily attach to walls and top plate with 2 - 2" screws. Gables may need slight adjustment in **Step 35** when attachment will be completed with an additional 6 - 2" screws. Screw from the bottom of gable framing down into Top Plate and Wall. **Hint:** Use a straight edge to check the angle of the gable framing and top plate. Both angles should line up (see diagram below).

Flashing overhangs wall on outside.

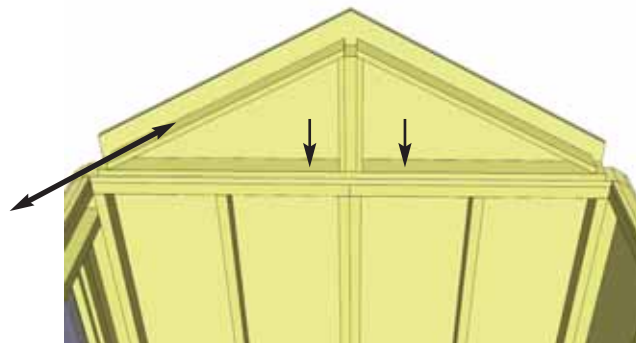
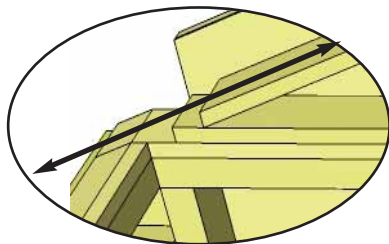

Use a straight edge to check that angle of gable lines up with top plate angle. Adjust gable for best fit.

25. Align and attach opposite Side Gable Wall as per **Step 24**. Flashing will overhang wall on outside. (See Diagram **Step 53**)

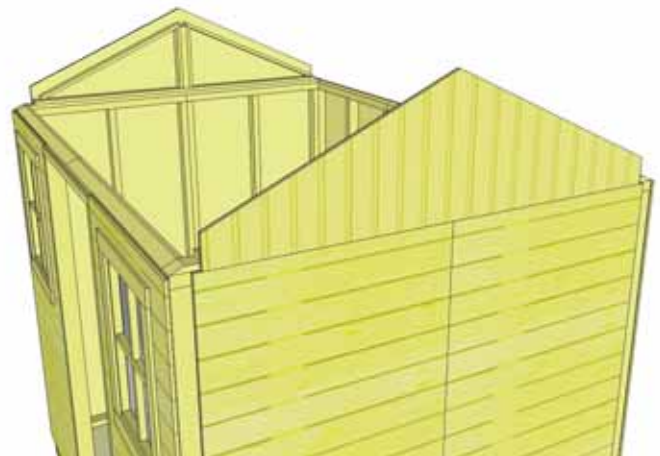

C. Rafter and Roof Section

Exploded view of all parts necessary to complete the Roof Section.
Identify all parts prior to starting. (Roof Filler Shingles Missing)

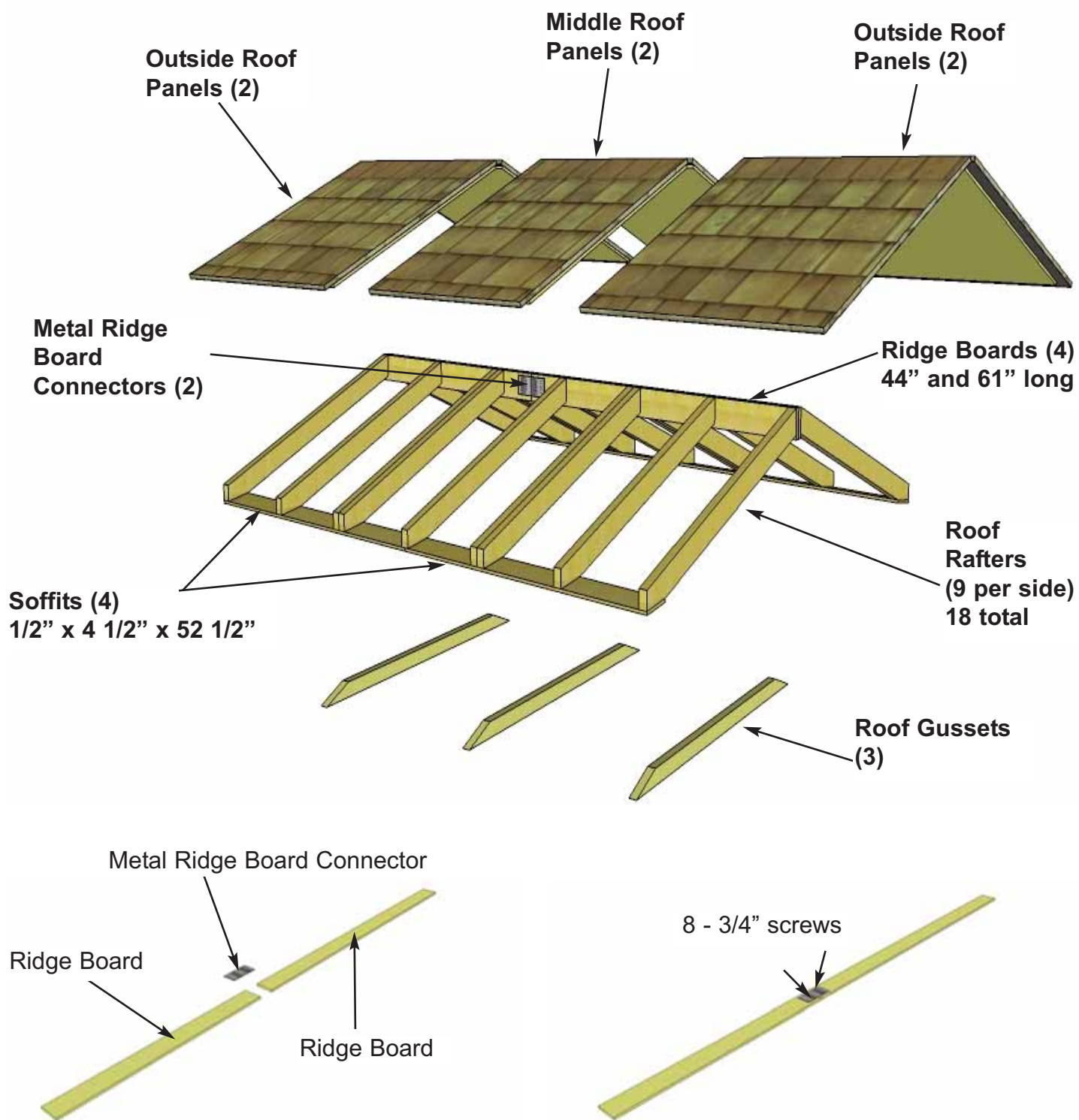

26. Locate (1 each) 3/4" x 4 1/2" x 44" & 61" **Ridge Boards** and attach together with **Metal Ridge Board Connector** using 8 - 3/4" screws. Total Length when connected is 105". Complete two Sets. Position Metal Ridge Board Connector evenly on Ridge Boards.

27. Locate 9 **Rafters** (1 1/2" x 3 1/2" x 45"), 2 **Soffits** (1/2" x 4 1/2" x 52 1/2") and completed **Ridge Board**. Lay out on level ground as shown to the right. Double up Rafters as illustrated. Screw doubled up Rafters together with 3 - 2 1/2" screws per piece.

Doubled up Rafters
- screw together with
3 - 2 1/2" Screws.

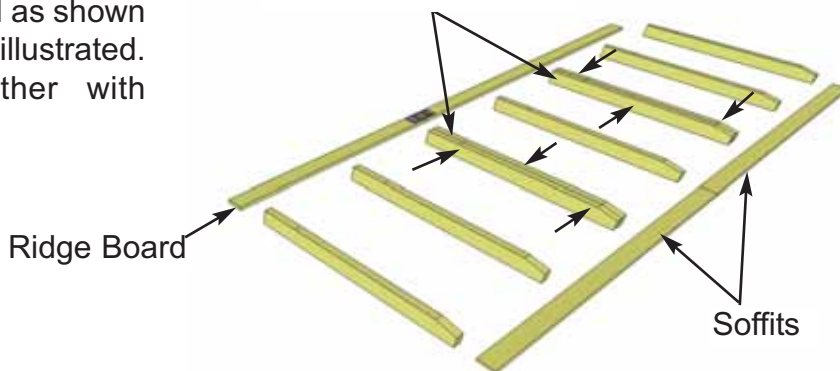

Important: Pilot Hole Ridge Board to prevent splitting!

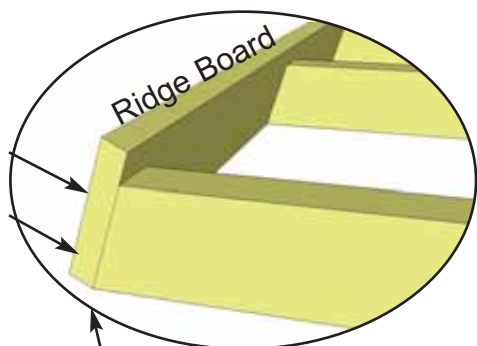

28. Attach completed Ridge Board to ends of both outside rafters with 2 - 2" screws per end. Measure and position interior Rafters as illustrated below. When positioned correctly, attach Ridge Board to remaining rafters with 2 - 2" screws /rafter end.

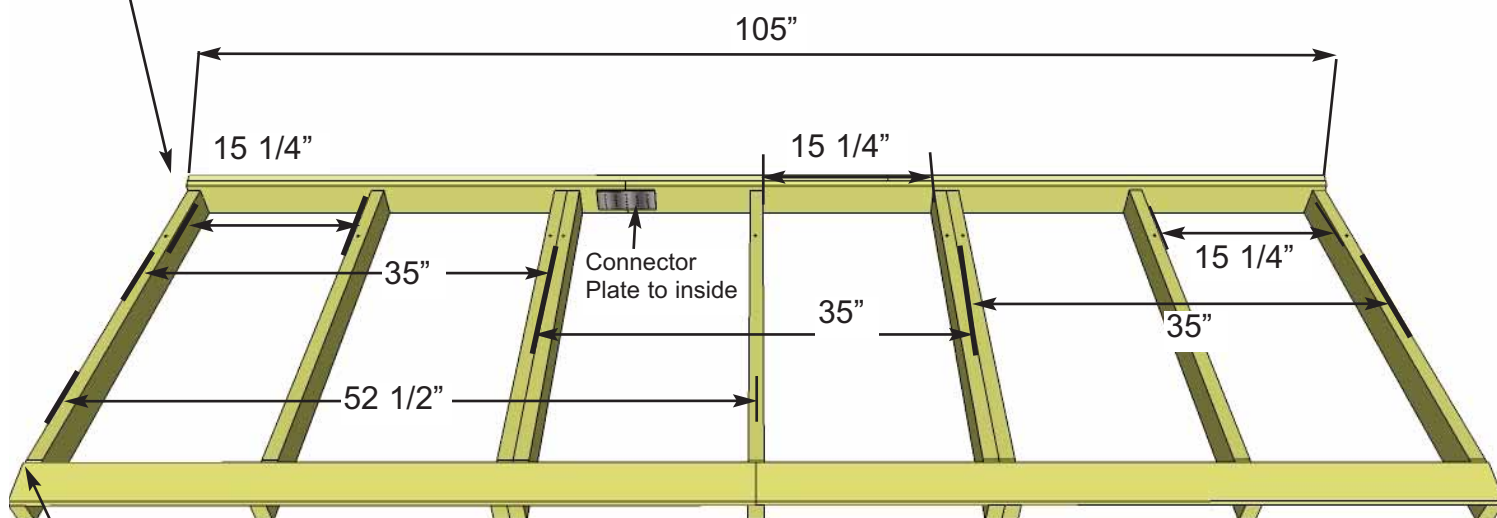

Important: Pilot Hole Soffit to prevent splitting!

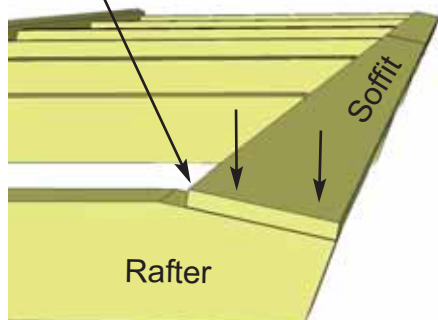

29. Attach end of a 52 1/2" long **Soffit Board** flush to ends of outside rafters with 2 - 1 1/4" screws per rafter end. Drill pilot holes in Soffit to prevent splitting. Complete both outside rafter / Soffit connections first. Measure and position interior Rafters as illustrated above. When positioned correctly, attach Soffit to remaining rafters with 2 - 1 1/4" screws /rafter. Flip completed rafter section over. Complete 2nd Rafter section now as per **Steps 27 - 28** with the following exception - **When attaching Ridge Board to Rafter ends, make sure Metal Ridge Board Connector is positioned so offset to first Rafter Section. See Step 33 for illustration.**

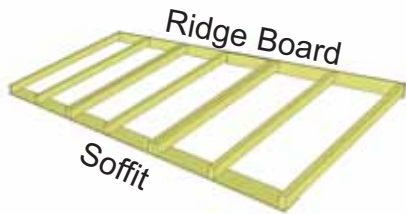

30. Flip Rafter Section over so Soffit is facing down. Starting with the rear Section, lift completed rafters up and place on gable framing.

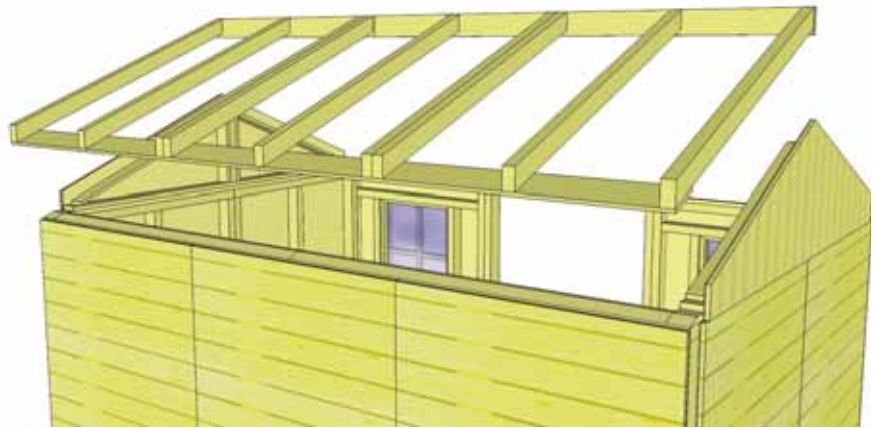

31. Slide Rafter Section up on gable framing until bottom of Ridge Board slips into gable notch.

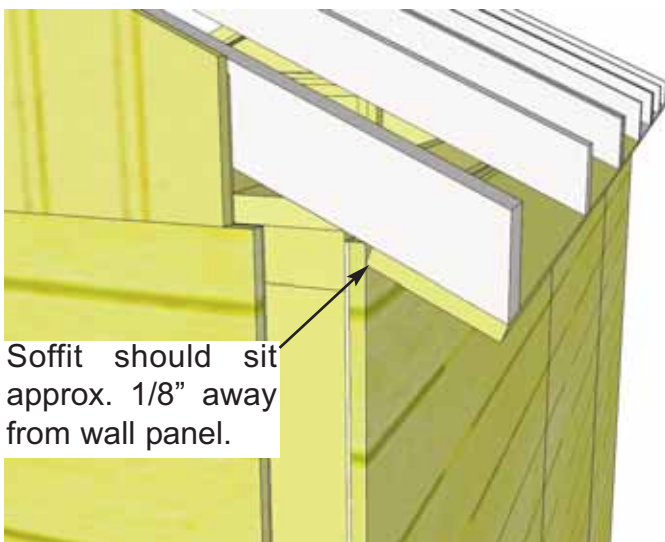
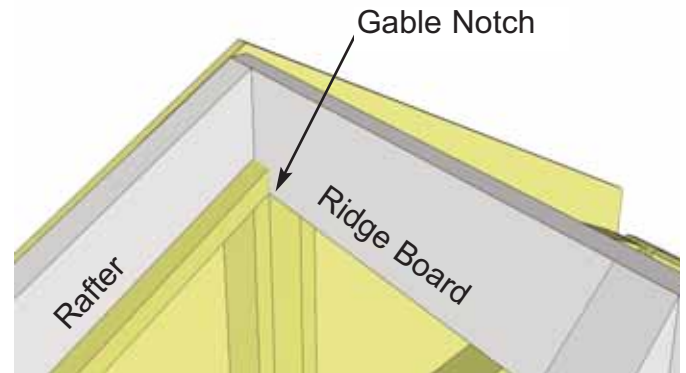
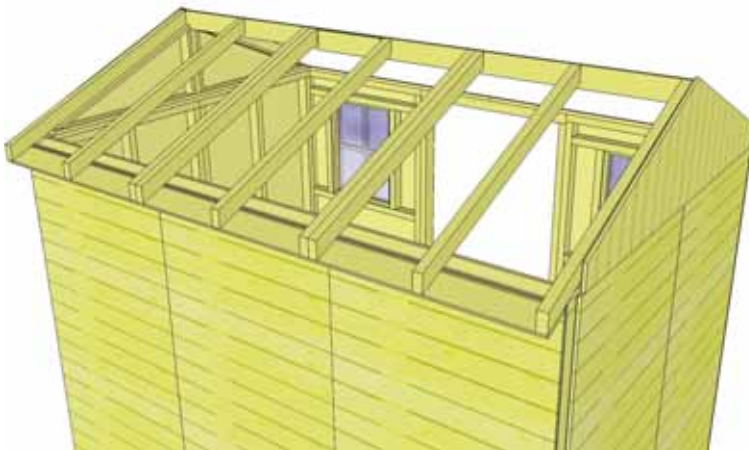

Soffit should sit approx. 1/8" away from wall panel.

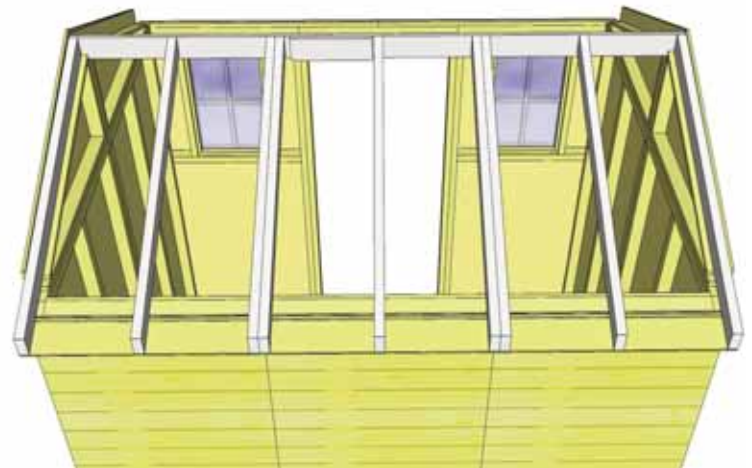

32. When Rafter Section is correctly positioned, outside rafters will sit equally on gable framing and Soffit will sit approximately 1/8" away from wall panels.

33. Place front completed Rafter Section on gable walls as per **Steps 31 & 32.**

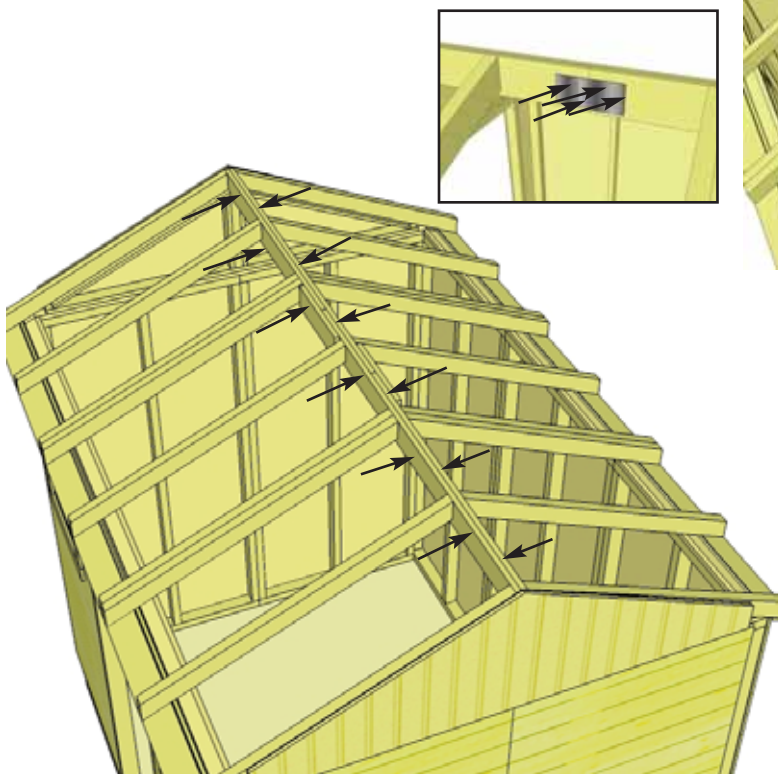
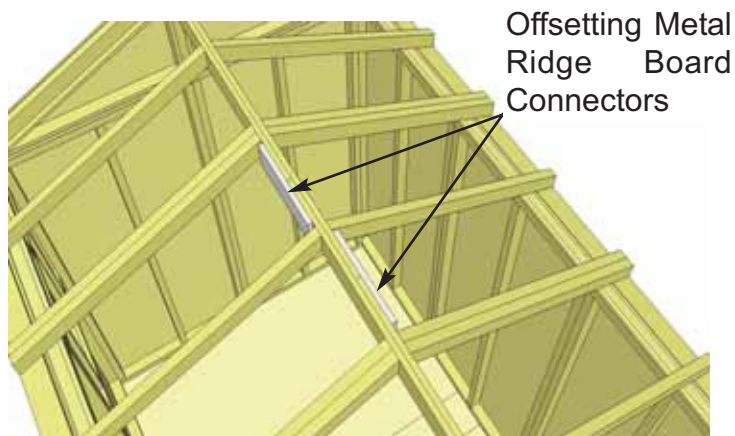
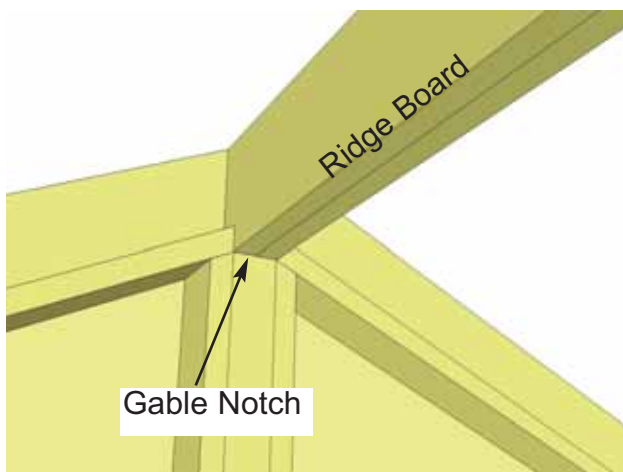

34. At the peak, align Ridge Boards so they are flush together and secure them with 12 - 1 1/4" screws. **Important:** if there is a gap between Ridge Boards, have a helper push the front and rear walls closer together from outside. Walls should be 70" apart at top from inside of wall plate to opposite wall plate. To completely secure Ridge Boards, place 4 - 1 1/4" screws into any of the remaining Metal Ridge Board Connector holes. Complete both sides.

35. With both Ridge Boards connected, completely secure Gable framing to walls and rafters. Use 4 - 2" screws per Rafter. Use an additional 6 - 2" screws to secure Gable to wall. **Note: you may have to remove the 2 temporary screws in Gable from Step 24 and reposition Gable for best fit prior to completing gable attachment.**

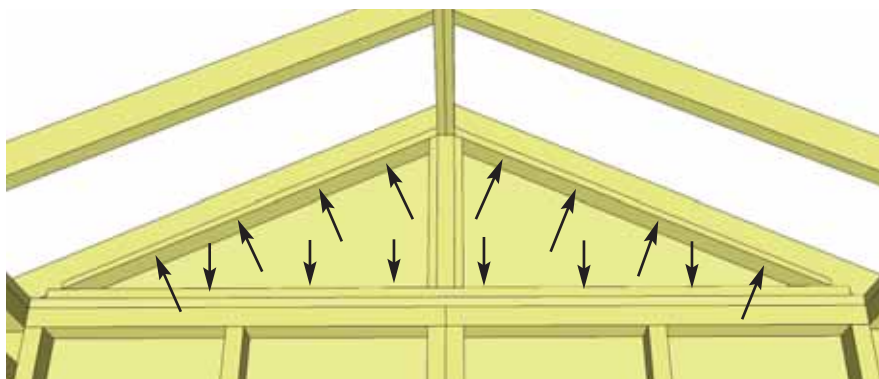

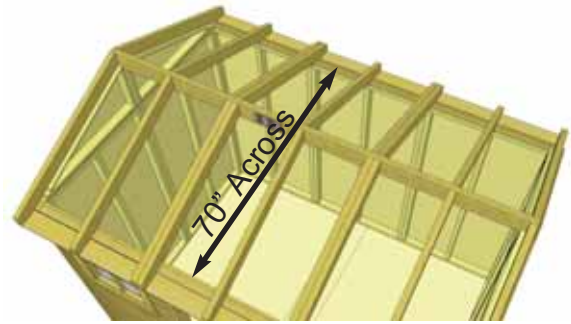
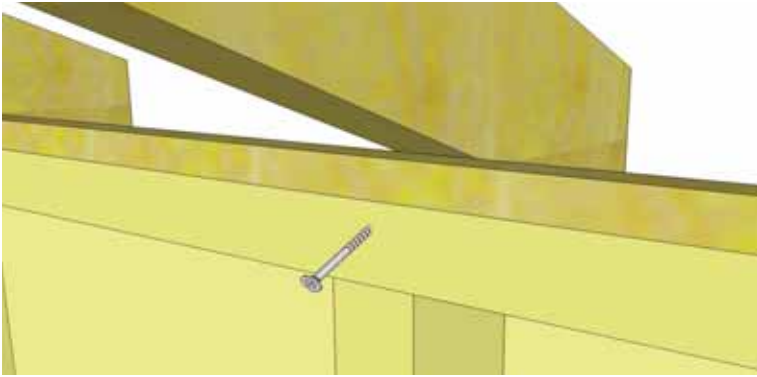

36. Secure Rafters to Top Wall Framing with one 3" screw per rafter. Screw through Wall Frame at an angle. Have two helpers push the Front and Rear Walls at the top from the outside of shed until inside to inside measurement between the Top Plates is 70".

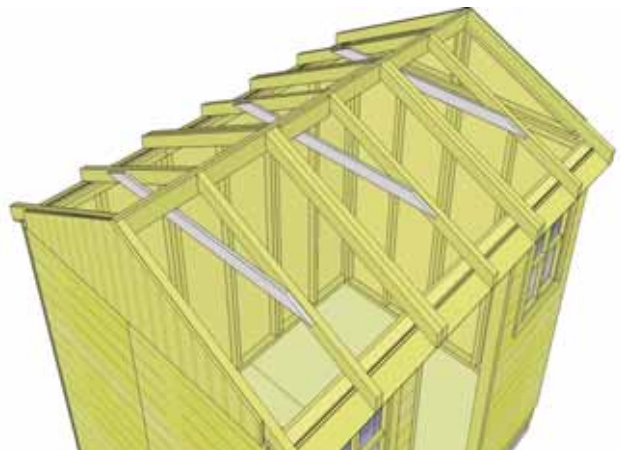
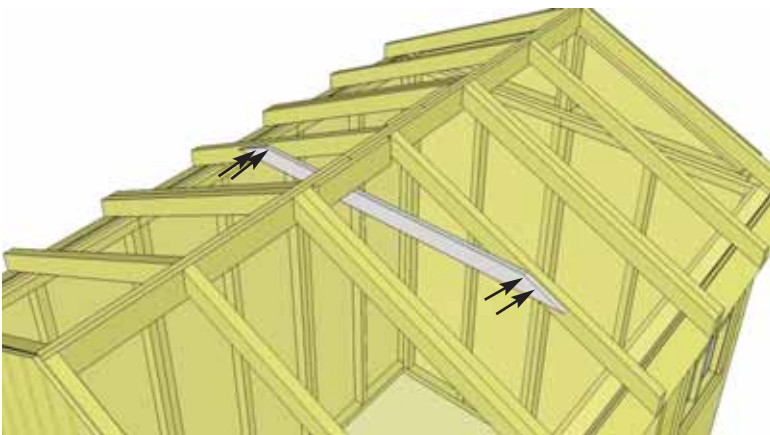

37. **Roof Gussets** (3/4" x 3 1/2" x 48") are positioned on mid rafters. Slide gusset up on side of rafters. Gusset must be below top edge of rafter. Use level to square gusset and attach to rafters with 4 - 2" screws. Pilot hole each Gusset end with 1/8" drill bit.

38. Complete remaining 2 Gussets as per **Step 37.**

Exploded view of upside down roof panels. Shingles overhang plywood on outside panels.

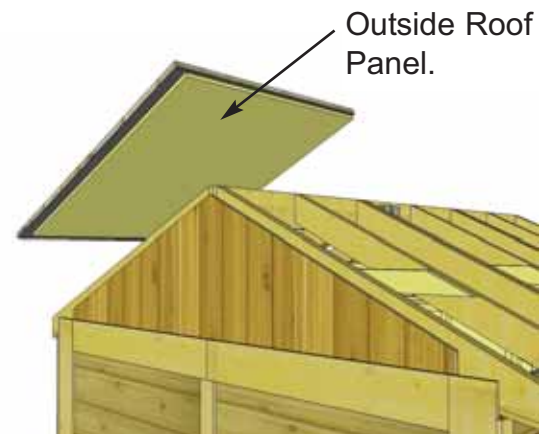
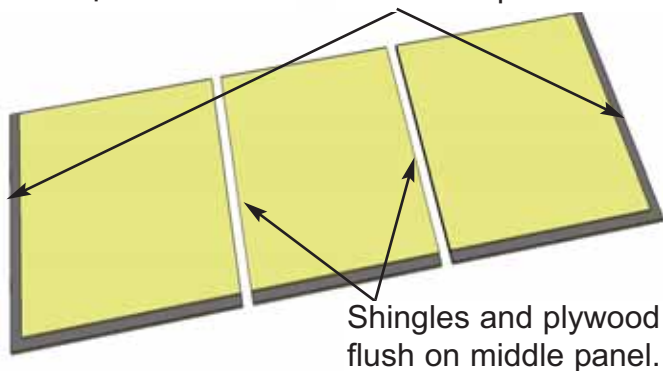

39. Identify all **Roof Panels**. There are 4 Outside and 2 Middle Roof Panels. Outside Panels will have shingles overhanging the plywood on one end. Lift up and place an Outside Roof Panel on Rear Rafters.

Roof Plywood flush with rafter end.

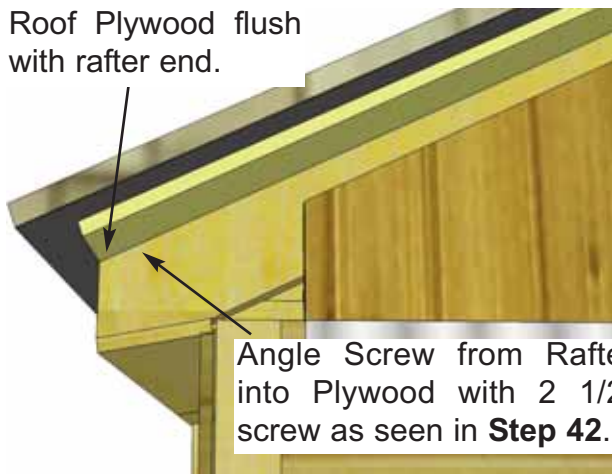

Angle Screw from Rafter into Plywood with 2 1/2" screw as seen in **Step 42**.

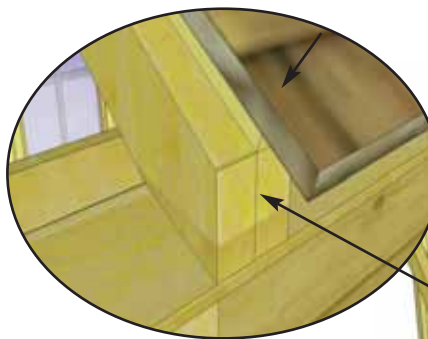

2 1/2" Screw in Bottom Row of Shingles

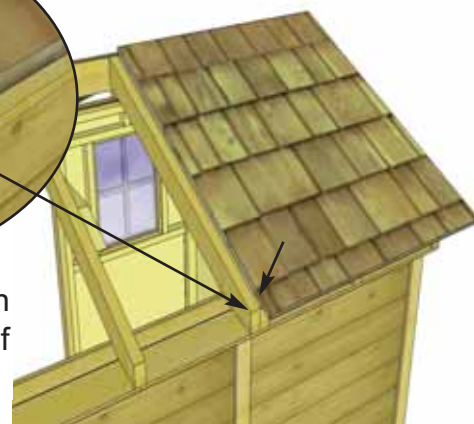

40. Place Outside Roof Panel so it sits flush on 3rd rafter from the outside (doubled up rafter). Plywood on roof should be flush with end of rafter at bottom, and with seam of doubled up rafters. From the outside, screw down through bottom row of shingles into rafter with 1 - 2 1/2" screw. Angle a 2 1/2" screw from outside rafter into roof plywood.

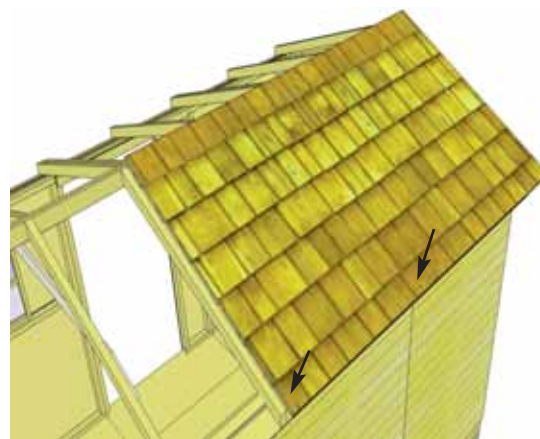
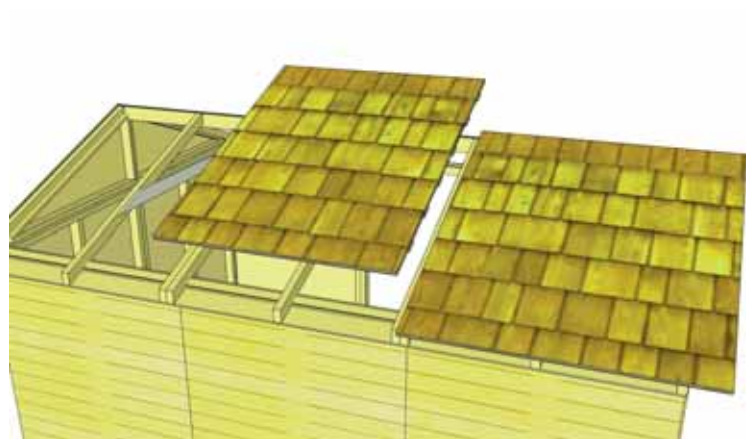

41. Locate Middle Roof Panel (roof plywood flush with outside of shingles), and place on middle rafters. Align panel as per **Step 40** and screw panel down to rafters with 2 - 2 1/2" screws in the bottom row of shingles.

Shingles overhang plywood on Outside Roof Panel.

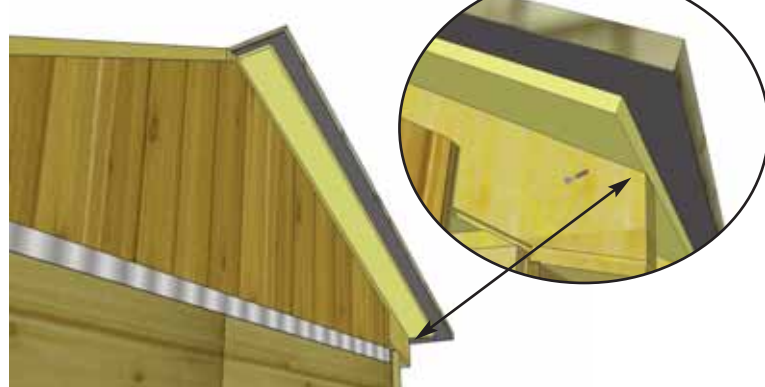

42. Lift up, position and attach 2nd Outside Roof Panel on Rafters as per **Step 40**.

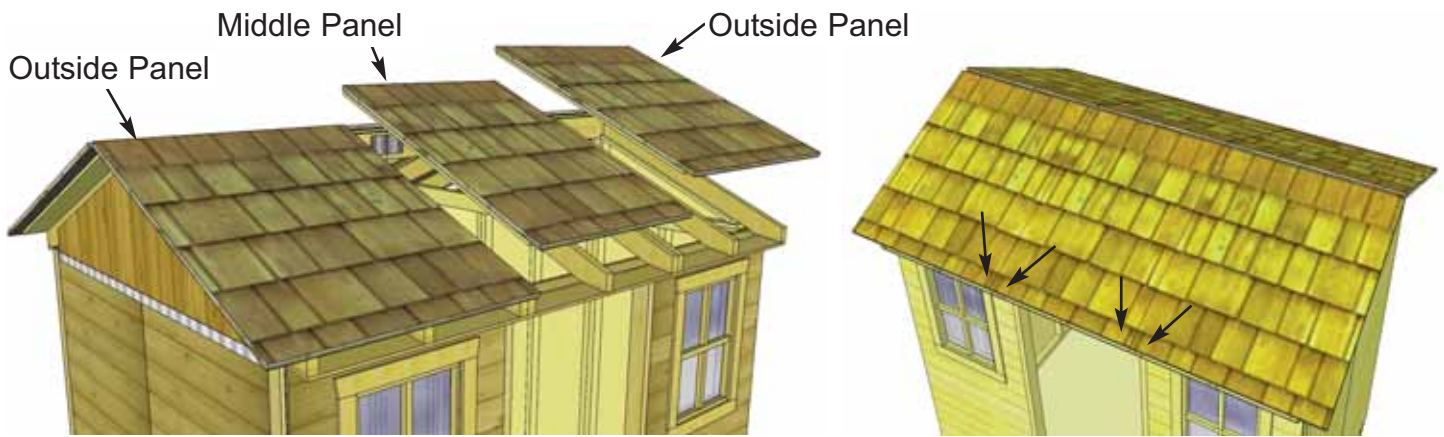

43. Position and attach Front Roof Panels as per **Steps 39-42.**



44. Roof **Filler Shingles** are included to cover roof seams. Starting at the bottom, slide the first Long Shingle in until flush with other bottom shingles.

45. Screw first filler shingle down to rafters using 1 - 2 1/2" screw per panel (2 in total). Make sure to screw into both rafters.

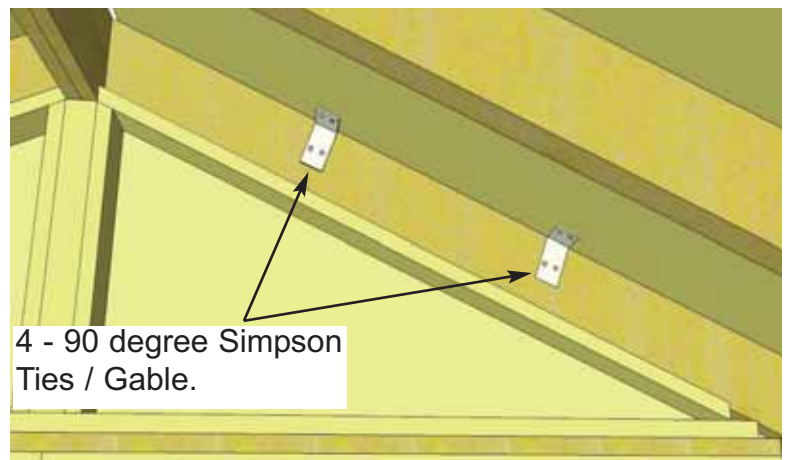

46. Slide in another filler shingle and attach as per **Step 45.** On your last row of shingles, attach smaller filler shingle with 2 - 1 1/4" Shingle nails near the top, to be covered by Ridge Caps in **Step 56.** Inside the shed, position 2 Simpson Strong ties on plywood and outside rafter and secure with 4 - 1 1/4" screws each. Complete for both Gables - there are 4 ties per Gable.

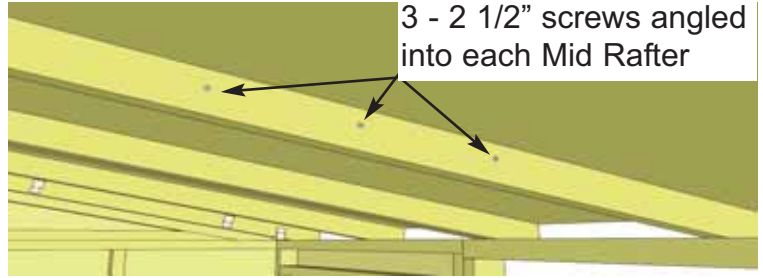
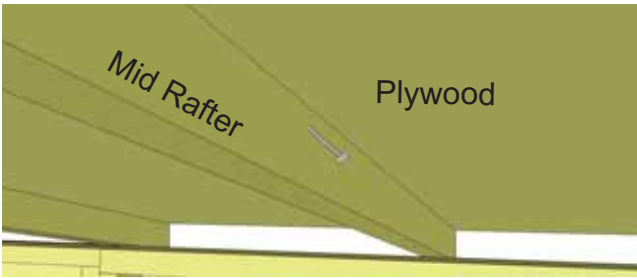

47. To further secure roof panels, from the inside, drill pilot holes in each Mid Rafter (3 per Rafter) on an angle. Using 3 - 2 1/2" screws, secure rafters to roof plywood. **Note:** from outside, have a helper push roof panel down so plywood sits flush against rafter when securing.

D. Miscellaneous Section

Exploded view of all parts necessary to complete the Miscellaneous Section. Identify all parts prior to starting.

Note: missing from exploded drawing: Interior Door Stops; 1 Interior Barrel Bolt

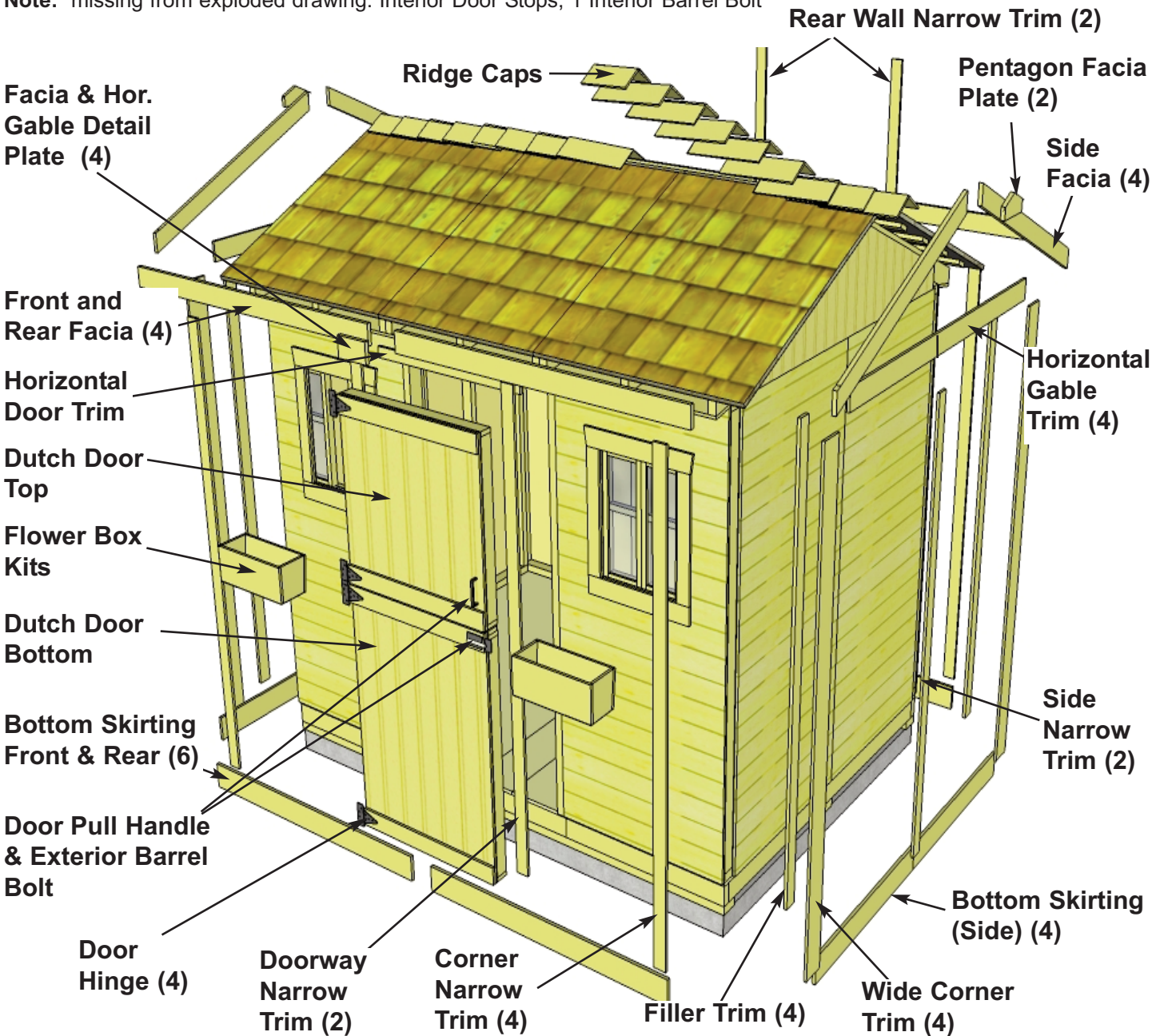

Expert Advice: When installing trim, sort pieces according to color and pieces that are most pleasing to the eye. Start with least visible side of shed and use the least desirable pieces first. Install trim to most visible side of shed as your skill installing trim improves.

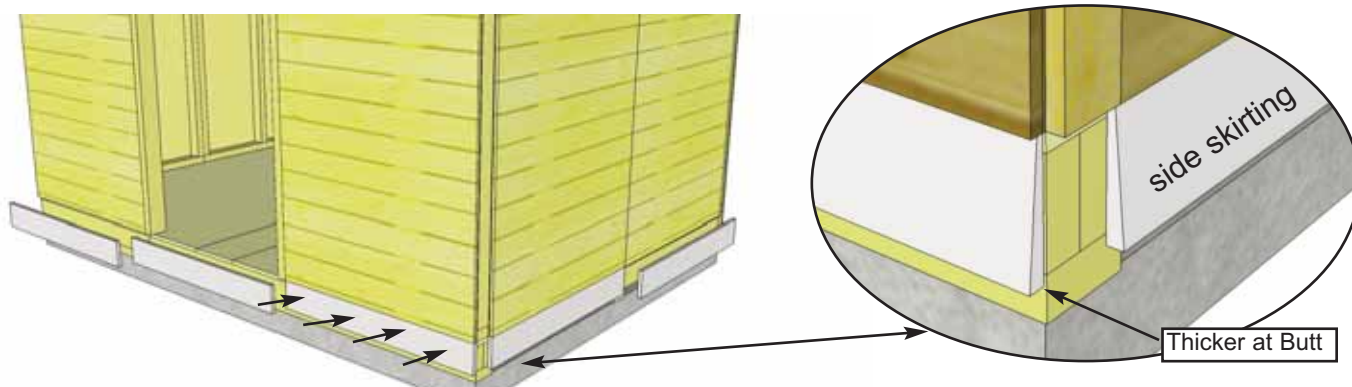

48. Attach **Bottom Bevel Skirting** (1/2" x 4 1/2" x 34 3/4"-Bevel is thicker at butt and thinner at top of board) around the base of the shed. Skirting will hide floor framing. Gaps on side will be covered by Wide Trim pieces later. Start with front and rear skirting pieces first and attach with 4 - 1 1/2" finishing nails per piece.

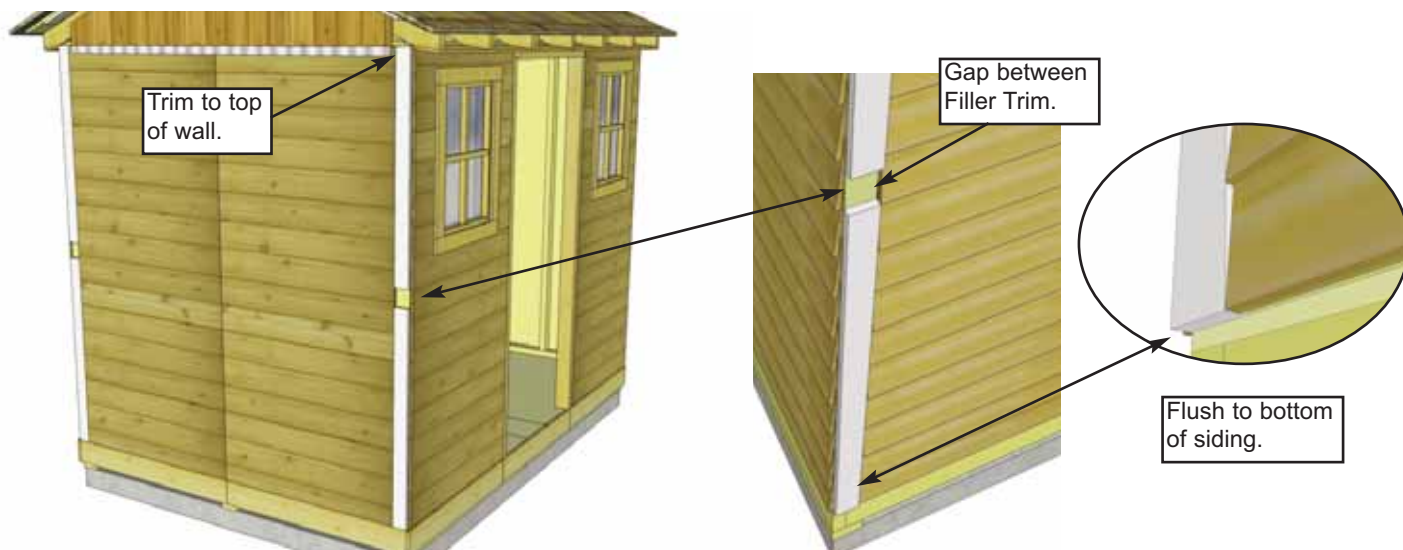

49. Attach **Filler Trim** (8 - 5/8" x 2 1/2" x 36") to each corner side wall (2 per corner). Align Filler Trim so it sits flush with top of Skirting. Attach with 4 - 1 1/2" finishing nails per trim.

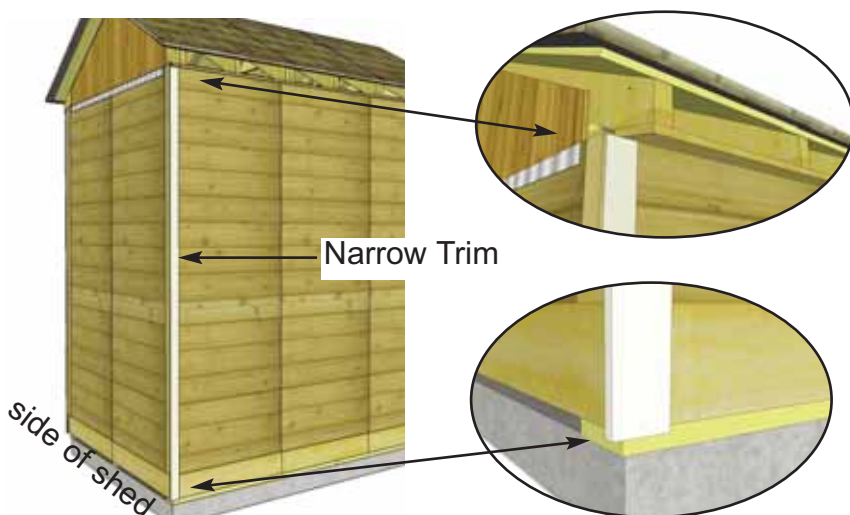

50. Align and attach both **Narrow** and **Wide Trims** to each corner. Starting with a Narrow Trim (1/2" x 2 1/2" x 79"), align tight underneath Soffit and Rafter. Narrow Trim will cap Wide Trim when attached in **Step 51**. Note that Narrow Trim will sit slightly below Bottom Skirting when correctly attached. Do a dry run with both Narrow and Wide Trims prior to attaching to confirm positioning. Use 8 - 1 1/2" finishing nails to secure.

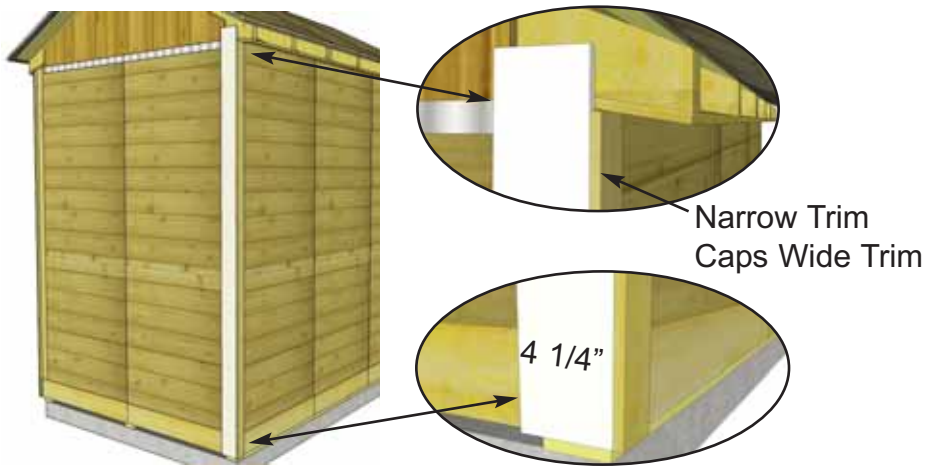

51. Position **Wide Trim** (1/2" x 4 1/4" x 82") over Filler Trim and tight against overhanging Narrow Trim. Align Wide Trim at bottom with Narrow Trim so flush with each other. Secure trim with 8 - 1 1/2" finishing nails. Complete remaining corner trims.



52. Attach **Rear Wall Narrow Trim** (2 - 1/2" x 2 1/2" x 79") where wall panels come together and leave a seam. Position trim equally on wall seam and tight underneath Soffit and Rafter. Use 8 - 1 1/2" finishing nails per piece to secure. Attach both **Side Wall Narrow Trims** (77 1/2" long) where wall seams come together on sides. Position trim equally on wall seam and slightly below Bottom Skirting as per Narrow Trim. Use 8 - 1 1/2" finishing nails per piece to secure.

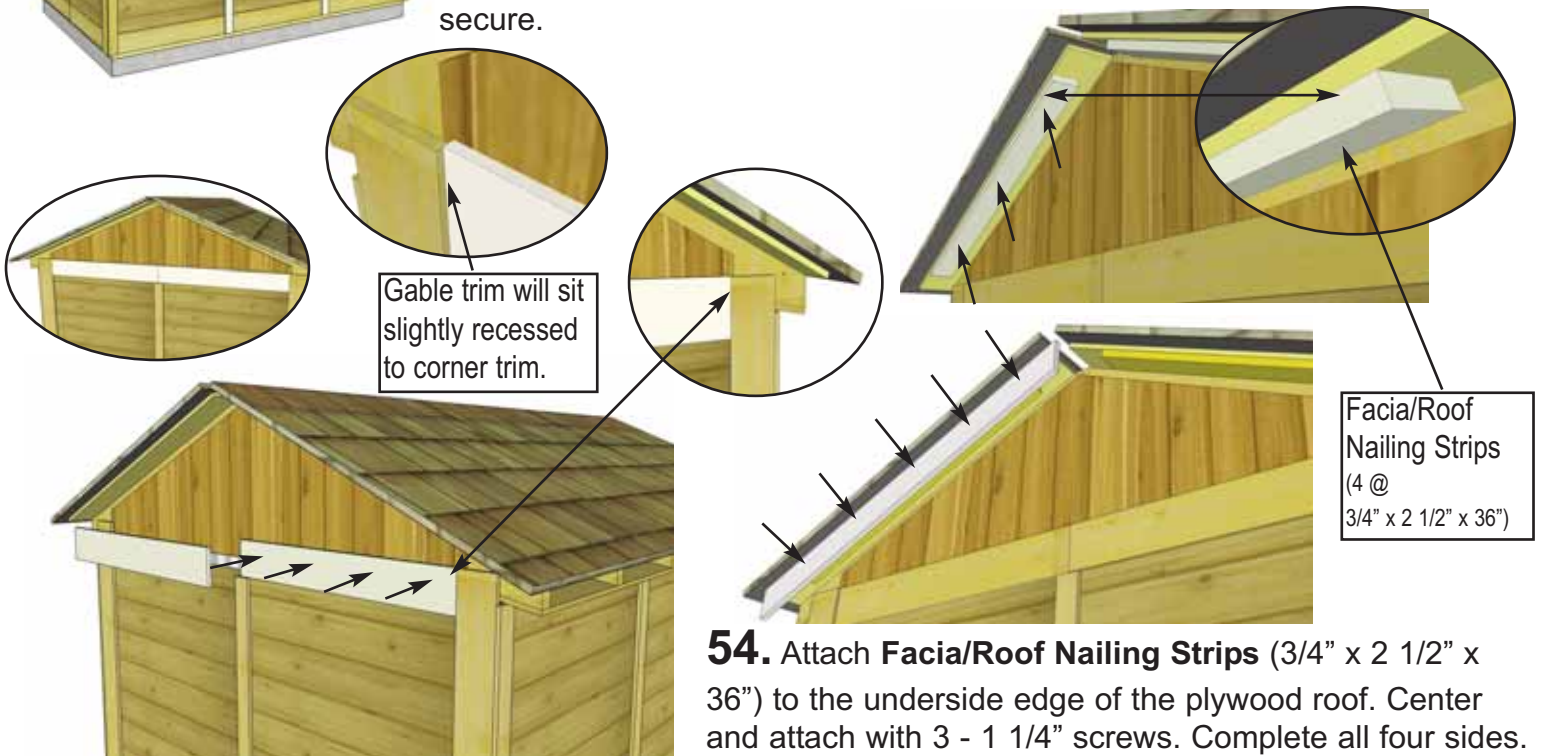

53. Attach **Horizontal Gable Trims** (4 - 1/2" x 4 1/2" x 33 3/4") to both sides of shed (2 per side). Position over gable and wall seam. Use 4 - 1 1/2" finishing nails to secure each piece. Align Gable Trim with top of Wide Trim as illustrated above.

54. Attach **Facia/Roof Nailing Strips** (3/4" x 2 1/2" x 36") to the underside edge of the plywood roof. Center and attach with 3 - 1 1/4" screws. Complete all four sides. Attach **Side Facia** (3/4" x 3 1/2" x 46" angle cut on ends) to end of roof panel plywood and nailing strip. Line facia up to form a peak and attach to nail strip /plywood with 6 - 1 1/2" finishing nails per piece. End of facia should be aligned flush with end of rafter. See **Step 55** for detail. Gap where facia boards come together at peak will be covered in **Step 58**.



55. Attach **Front and Rear Fascia** (3/4" x 3 1/2" x 57 1/4") to roof rafter ends. There are 2 fascia pieces per side. Secure with 8 - 1 1/2" finishing nails per piece.

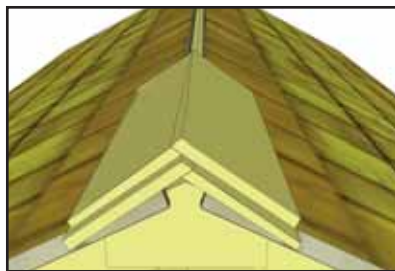
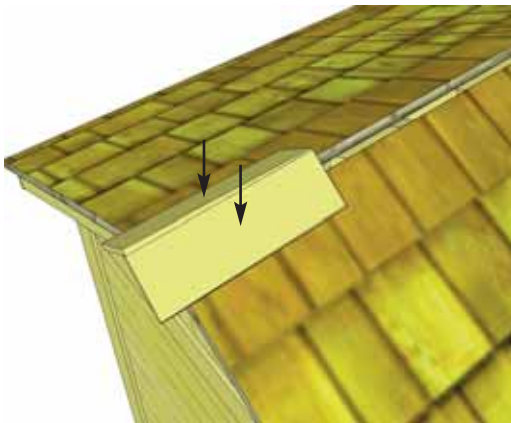

Important: Butt (thick) end of Ridge Cap will be facing towards the outside of shed.

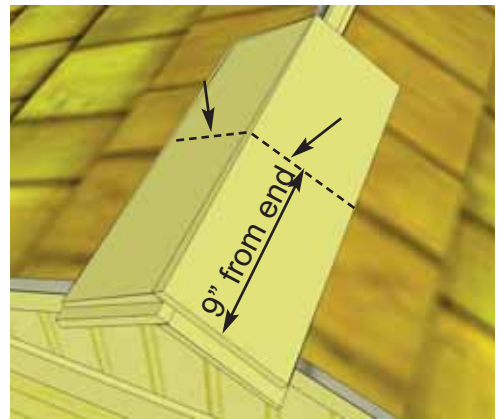

56. Place 1st **Roof Ridge Cap** on roof peak overhanging shingles by approximately 1". Attach with 2 - 1 1/4" Shingle Nails 9" from end. Place 2nd Ridge Cap 1" back from 1st cap. Attach with 2 - 1 1/4" Shingle Nails 9" from end.

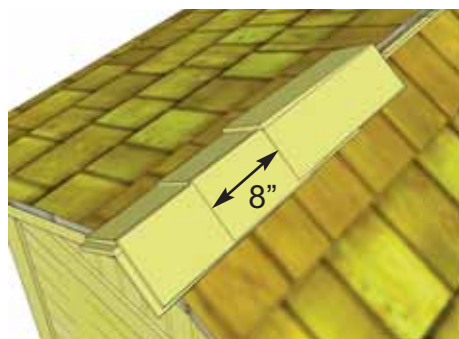
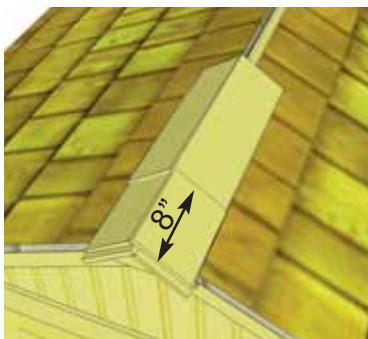

57. Place 3rd Ridge Cap 8" back from 2nd (enough to cover shingle nails). Attach 3rd Ridge Cap as per **Step 56**. Continue to position and attach Ridge Caps until half the roof is complete. From opposite side, position and attach Ridge Caps as described above. Score/cut 1 Ridge Cap to 12" or to fit in the center of roof. Attach center cap with 4 - 1 1/4" Shingle Nails.

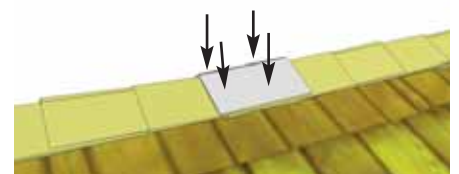

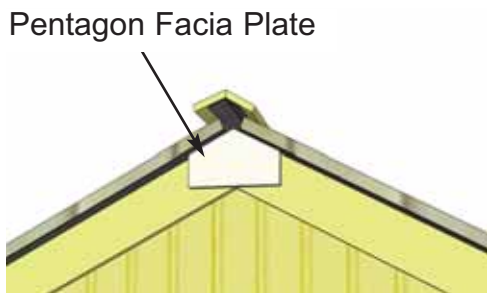

Pentagon Facia Plate



Hor. Gable Detail Plate

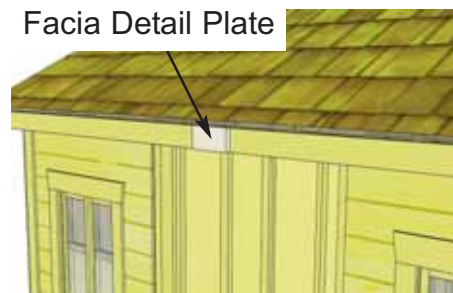

Facia Detail Plate

58. Attach **Pentagon Facia Plate** where Side Facia meet at the peak. Use 4 - 1 1/2" finishing nails per piece to secure. Attach **Facia Detail Plates** to cover seams where Front and Rear Facia Trim pieces come together. Secure each with 4 - 1 1/2" finishing nails. **Attach Horizontal Gable Detail Plates** to both side gables with 4 - 1 1/2" nails per side. Horizontal Plates are larger than Facia Plates.



Narrow Trims

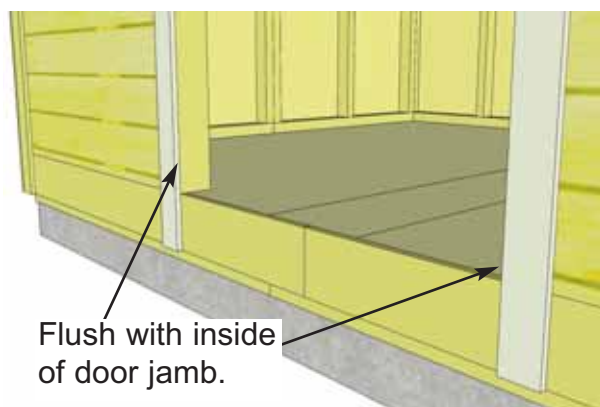

Flush with inside of door jamb.

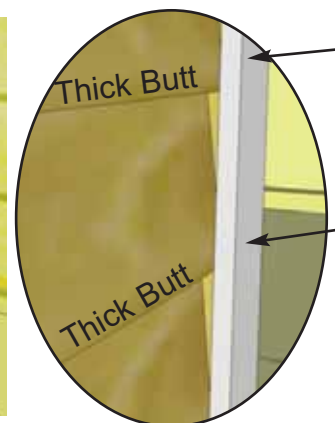

59. Position the 2 remaining **Doorway Narrow Trim** (2 - 1/2" x 2 1/2" x 79) pieces flush with door jamb and tight at top to soffit. Attach with 8 - 1 1/2" finishing nails. Nail into the thick part of the bevel siding.

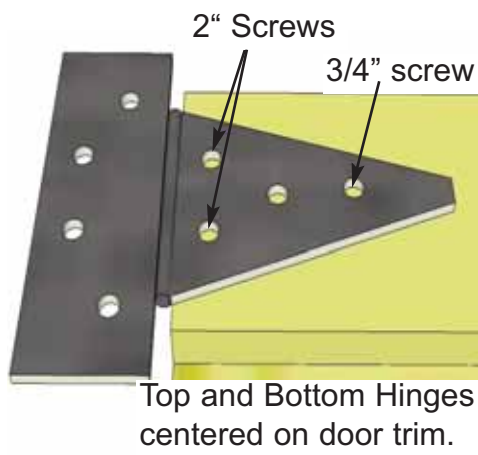

Top and Bottom Hinges centered on door trim.

Important: Hinge not exactly as shown.



Top Door

Center Hinges offset

Bottom Door

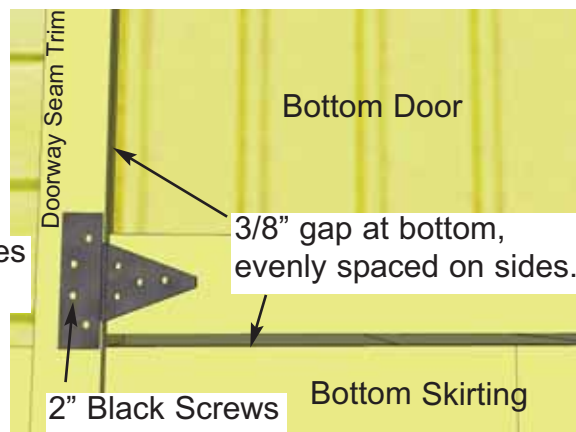

Bottom Door

3/8" gap at bottom, evenly spaced on sides.

2" Black Screws

Bottom Skirting

60. Attach Door Hinges to Top and Bottom Dutch Door sections. At this stage, door can swing open on the left or right. Decide on your preference and attach hinges to door (2 hinges per door). Center Hinges should be positioned to edge of door trim to prevent hinges from contacting each other, while top and bottom hinges may be centered on door trim. Use 2" & 3/4" black screws on hinge / door attachment as shown above.

61. Place Bottom Dutch Door panel into position, 3/8" gap on bottom and evenly spaced on sides, and attach hinge to doorway seam trim with 2" black screws. Use shim to help keep the door evenly spaced on bottom. One of the extra roof shingles (see parts list) can be used as a shim.

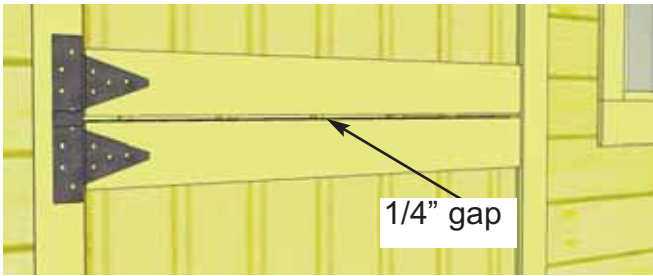

62. Place the Top Dutch Door Panel into place and gap top and bottom panel 1/4" apart. Use a shim once again to help you. Attach hinges to trim with hinge hardware provided.



63. Attach **Horizontal Door Trim** (1/2" x 1 1/4" x 32") with 4 - 1 1/2" finishing nails to cover Header.

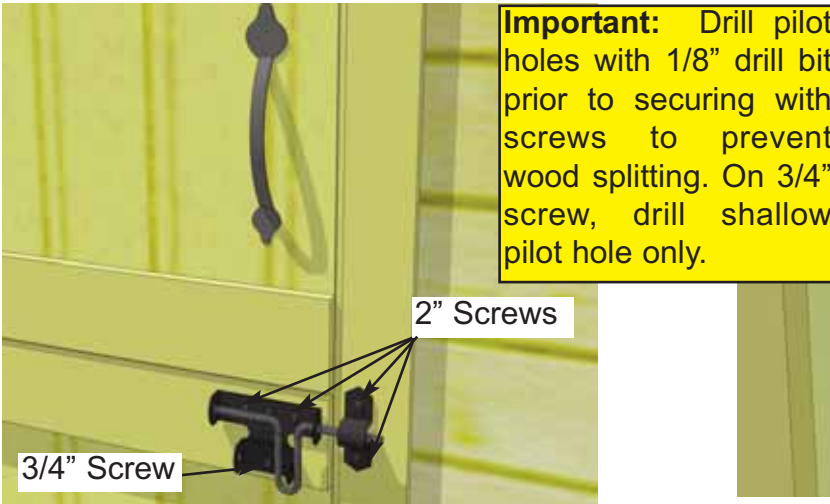

64. Attach **Door Handle** and **Exterior Black Barrel Bolt** to door. Handle is positioned on top door, Barrel Bolt on bottom door. Attach Black Barrel Bolt as illustrated above with 2" & 3/4" Black Screws. Note how female part of Barrel Bolt is positioned higher than male. Do a dry run first to position Barrel Bolt correctly.

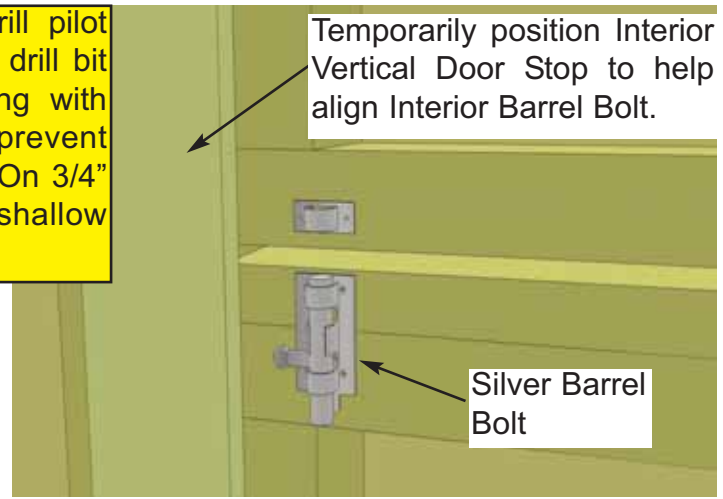

65. Attach **Interior Silver Barrel Bolt** to inside of door as illustrated above. Use 3/4" silver screws to secure. Refer to **Step 66** to allow for adequate clearance.

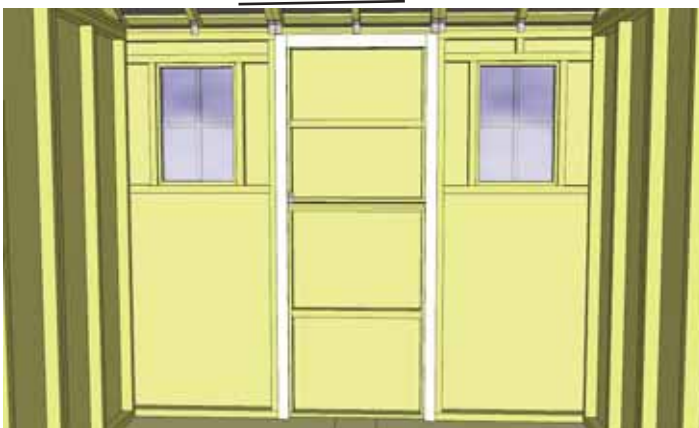

66. Attach **Interior Door Stops** to door framing (Jambs and Header). Start with Vertical pieces first (1/2" x 2 1/2" x 72"). Stops should overlap doorway by 1/2". Use 4 - 1 1/4" screws to secure each Stop. Attach Horizontal Stop next (1/2" x 2 1/2" x 36") using 3 - 1 1/4" screws.



67. Assemble **Flower Box** with Assembly Instructions included. Position completed Flower Box below bottom of window trim and secure with 2 - 2" screws per box. Screw from inside of box into the center wall stud. Attach second screw 2" underneath first screw and once again into the wall stud. Install Flower Box Kits underneath each window.

Alternate Door Configuration (Door on Left or Right of Center)

To configure the Cabana so the Door is positioned on the left or right of center wall panel, follow the general directions in this manual for a regular door configuration and note the following changes.

A. Follow sequential **Steps 9-17** in the Wall Section for regular configuration to position and secure wall panels. For Door on left side, align and attach two Window Wall Panels in center and right positions. For Door on right side, configure Window Walls on opposite side.

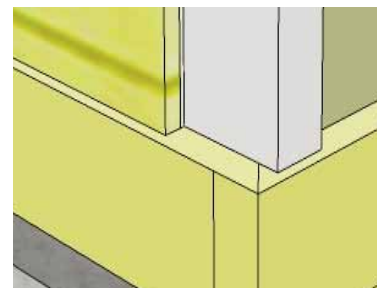
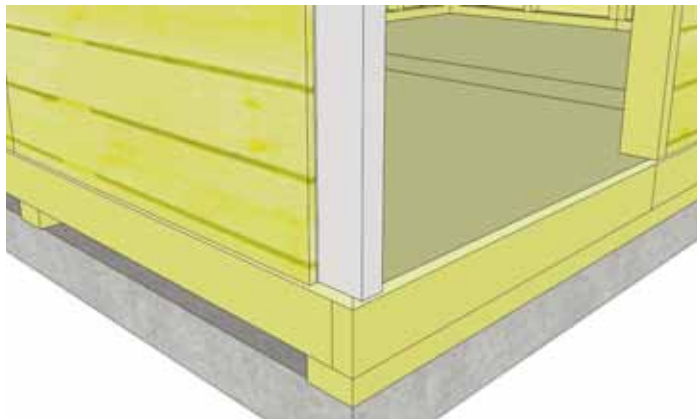
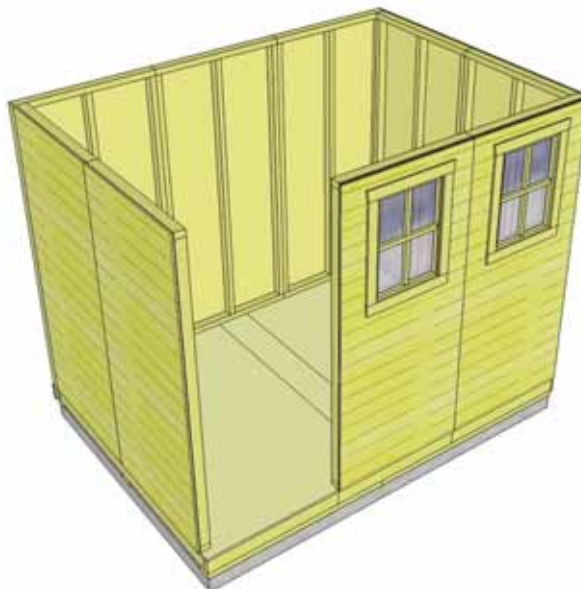

B. With walls positioned and attached together, locate Door Jamb and orientate on Side Wall Panel stud. Align Door Jamb so Flush with bottom wall plate of wall framing. Wall siding will overhang 1/2" on outside. Plate will overhang doorway side by 1".



C. When correctly aligned, attach Door Jamb to wall stud with 4 - 2 1/2" screws.

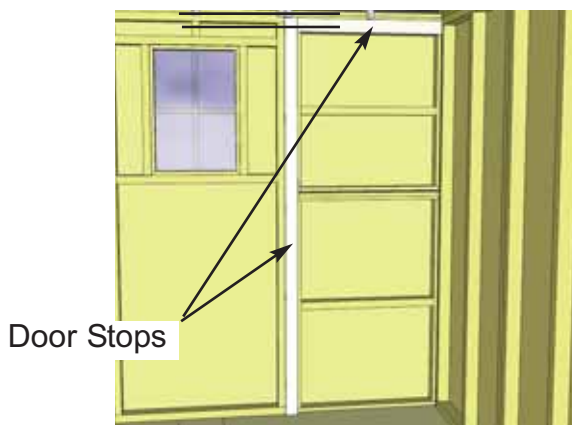

D. Attach 1 Vertical and Horizontal Door Stop. See **Step 66** for detail. May have to trim Horizontal Door Stop to fit.



Congratulations on assembling your 9x6 Cabana!

Note: Our Sheds are shipped as unfinished products. If exposed to the elements, the western red cedar lumber will weather to a silvery-gray color. If you prefer to keep the cedar lumber looking closer to the original color, we suggest that you treat the wood with a good oil base wood stain. You may also wish to paint your new shed rather than stain it. In both cases we recommend that you consult with a paint and stain dealer in your area for their recommendations.

We hope your experience assembling your 9x6 Cabana Garden Shed has been both positive and rewarding.

We value your feedback and would like to hear back from you on how well we are doing in the following areas:

1. Customer Service
2. On Time Shipping
3. Motor Freight Delivery
4. Quality of Materials
5. Assembly Manual
6. Overall Satisfaction.

Please call, write or email us at:

Outdoor Living Today

Canadian Address
9393 287th Street
Maple Ridge, British Columbia
Canada V2W 1L1

United States Address
P.O. Box 96
Sumas, Washington
USA 98295



The materials contained in this Assembly Manual may be downloaded or copied provided that ALL copies retain the copyright and any other proprietary notices contained on the materials. No material may be modified, edited or taken out of context such that its use creates a false or misleading statement or impression as to the positions, statements or actions.