



OWNER'S MANUAL

GENERAL GASOLINE ENGINE

62027

62029

PREFACE

Thank you for choosing a general gasoline engine by our company.

Based on the latest engine technology at home and abroad, our Co. has individually developed general gasoline engines with 4-stroke single cylinder, OHV and forced-air cooling. The engines are characterized by advanced design, compact structure, reliable performance, convenient service low fuel consumption and easy speed adjustment. They are widely used as ideal power in many fields such as generating set, tour, open working, public place of entertainment, construction machine, agricultural machinery, etc. the vital part bodies including cylinder cover, crankcase, etc, are all cast formed with aluminum alloy. Laser-scanning technology, 3D shaping technology and CN program processing technology used in the mould production upgrade the engine surface and manufacturing accuracy obviously. Applying auto-press reducing system and centrifugal fly hammer regulating system assure that assemblies equipped with the engine function smoothly and reliably as well as the engine start easily. Besides, the introduction of the lubricant film-sensing protection system prevents accidental damage of the engine for poor lubrication.

The manual gives information with respect to operation and maintenance of the general gasoline engine, and be sure to read it carefully first before operating. All the materials and diagrams of this manual are in accordance with the newest products at the publishing time. Due to revision and other change, the information described in this manual may be a little different from the actual status. The copyright of this manual belongs to our Co., any group or individual is forbidden to reprint or copy any it. The manual is subject to change without notice.

Please pay special attention to statements preceded by the following words:

⚠ WARNING

● A warning is used to alert the user to fact that hazardous operation and maintenance procedures may result in injury to or death of personnel if not strictly observed.

CAUTION

● A caution is used to alert the user to fact that hazardous operation and maintenance procedures may result in injury to or death of personnel if not strictly observed.

NOTE

● A note is used to give helpful information.

This manual book is the part of engine; it must be along with the engine.

CONTENTS

Safety Precautions.....	5
Parts Description.....	6
Pre-Operate Inspection.....	7
I. Engine Oil.....	7
II. Oil in the reduction gearbox (only for equipped model).....	8
III. Air cleaner.....	9
IV. Fuel.....	9
Starting of the Engine.....	11
Operation.....	13
Engine Oil Alarm.....	14
Breaker (electric start type).....	14
Operating on Highlands.....	15
Stop.....	16
Exhaust Control System.....	17
Maintenance.....	19
I. Maintenance schedule.....	19
II. Maintenance method.....	20

1) Replacement of the Oil.....	20
2) Maintenance of the air cleaner.....	21
3) Washing of Deposit Cup.....	22
4) Maintenance of the spark plug.....	22
5) Maintenance of the Spark Plug (Option)	24
6) Adjustment of Carburetor Idling.....	25
Transport and Storage.....	26
Troubleshooting.....	36
Specifications.....	37
Electric Diagram.....	39

SAFETY PRECAUTIONS

⚠ WARNING

Before operating the engine, be sure to read and familiar with the manual carefully, otherwise injury to personnel or damage to equipment may occur.

Please pay special attention to the following:

1. Running the engine in a well-ventilated place, keep it at least one meter away from building walls or other equipments; keep away from inflammables such as gasoline, matches and so on to avoid possibility of fire.
2. Keep the engine out of reach of children and pets to avoid accidents.
3. Operator on the engine has been specially trained.
4. Refuel in a well-ventilated area with the engine stopped, and in places refueling or storing gasoline, no smoking and any flames or sparks.
5. Refuel the fuel tank not too full so as to avoid fuel's spilling out. If there is spilled fuel around, be sure to clean it thoroughly before starting.
6. Locate the engine on a level-working platform to avoid fuel's spilling out.
7. Make sure the fuel filler cap is tightened securely.

The exhaust muffler is very hot during running the engine even after the engine stops. Never touch it, or you may get burns. Transport or store the engine with it cooling down entirely.

PARTS DESCRIPTION

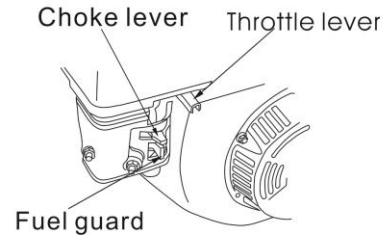
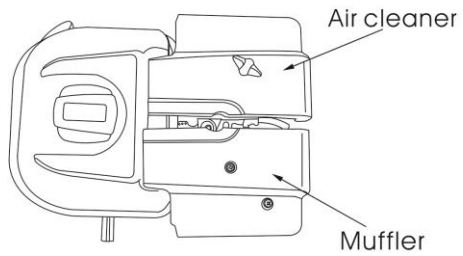
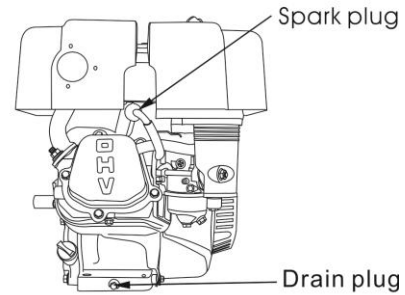
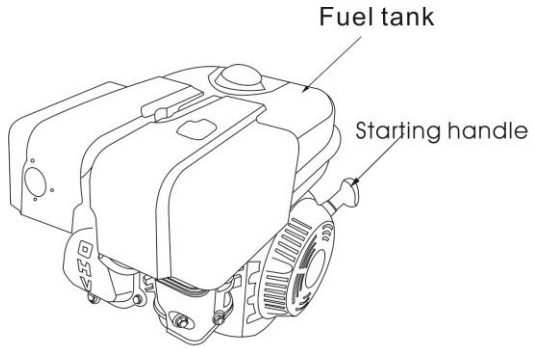

PRE-OPERATE INSPECTION

I .ENGINE OIL

CAUTION

- Engine oil is a key factor in deciding the engine's performance. Do not apply engine oil with additives or 2-stroke gasoline oil, as they haven't enough lubrication, which may shorten the engine's service life.
- Check the engine with it stopped on a level ground.

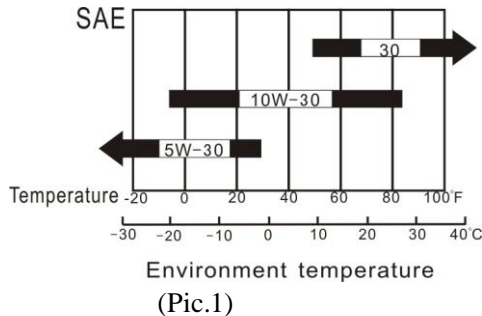

Engine oil recommended: SAE10W-30。 As viscosity varies with regions and temperatures, so the Lubricant has to be selected in accordance with our recommendation. (Pic.1)

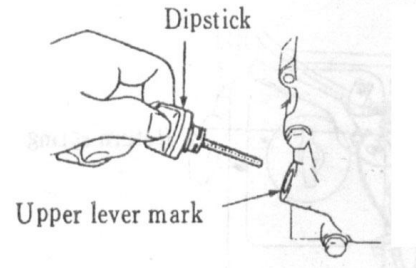

(Pic.2)

Inspect step:

1. Remove the dipstick and clean it. (Pic. 2)
2. Reinsert the dipstick into the oil filler without screwing in, and check oil level.

3. If the oil level is too low, add recommended engine oil to the filler neck.
4. Reinstall the dipstick.

CAUTION

Run with insufficient engine oil may damage the engine severely.

II. OIL IN THE REDUCTION GEAR BOX (only for the model equipped with it)

1/2 Reduction gearbox with an auto-centrifugal clutch.

1. Remove the dipstick and clean it. (Pic. 3. Pic.4)
2. Reinsert the dipstick without screwing it in, and then take out it and check oil level.
3. If the oil level is too low, and recommended engine oil until it arrives the upper level mark.

Brand of the oil is the same as that of engine oil.

Oil capacity: 0.50 liters

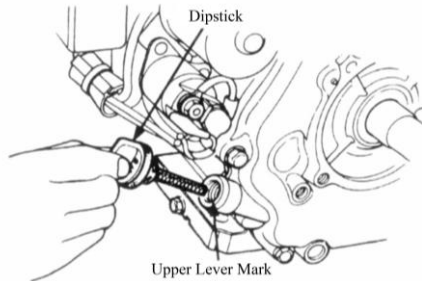

(Pic.3)

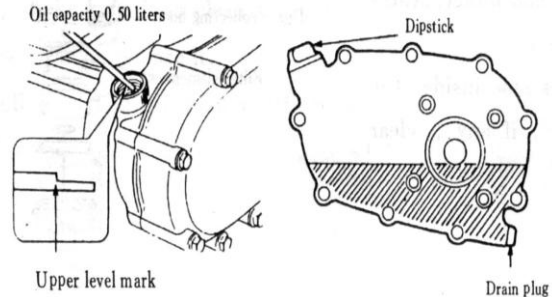

(Pic.4)

III. AIR CLENER (Pic. 5)

CAUTION

Never run the engine without an air cleaner, or severe wear of the engine may occur.

Dismantle the air cleaner housing and check its filter element, make sure it is clean and intact, otherwise clean or replace it.

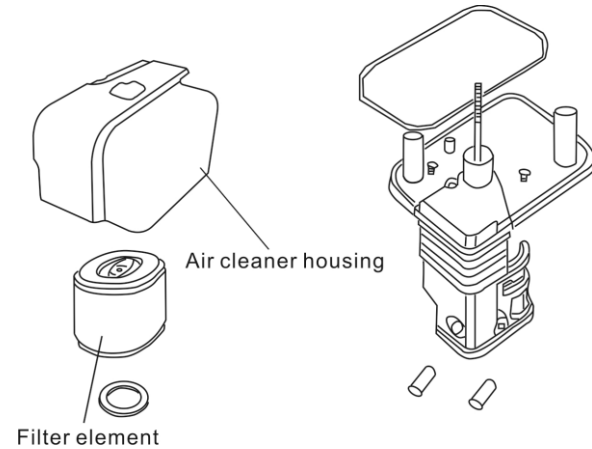

(Pic. 5)

IV. FUEL

1. Gasoline is extremely flammable and may explosive under certain conditions.
2. Refueling in a well – ventilation area with the engine stopped. Do mot smoke and allow flames or sparks
In the area where gasoline is stored or where the fuel tank is refueled.
3. Do not overfill the tank (there should be no fuel in the filler neck). After refueling, make sure the fuel tank cap is set back securely.
4. Be careful not to spill fuel when refueling. Spilled fuel or fuel vapor may ignite. If any fuel is spilled, make sure the area is dry enough before starting the engine.

5. Avoid repeated or prolonged contact with skin or breathing of fuel vapor. Keep out of reach of children.

Fuel tank capacity: 3.6liters

The engine must apply unleaded gasoline with an octane number over 86.Using unleaded gasoline will decrease the possibility of producing carbon deposit and prolong the engine's service life.

Never apply used or polluted gasoline or a mixture of gasoline and engine oil. Make sure the fuel is free of dirt and water.

CAUTION

- Handle fuel with care because it can damage plastic and painted surfaces. It is not in our guarantee range of damage by fuel spilling.
- It is normal when you hear occasionally light spark knock or pinking with the engine running under heavy load.
- Should spark knock or pinking be heard at a speed under normal load, change brand of gasoline; If such phenomenon still happens, consult your dealer for help, otherwise, the engine may be damaged.

CAUTION

The engine would be damage when it is running with constantly knock or pinking noise. It is not in our warranty range that its damage by misuse the engine

STARTING OF THE ENGINE

1. Push the fuel switch to “ON”. (Pic.6)

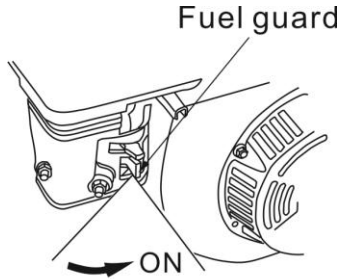

(Pic.6)

NOTE

If the engine is hot, closing the choke is unnecessary.

3. Move left the throttle lever a little. (Pic.8)

2. Push the choke lever to “OFF”. (Pic.7)

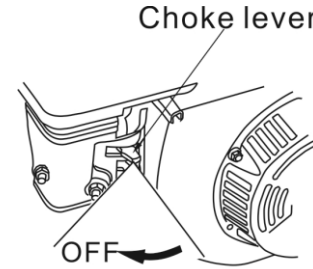

(Pic.7)

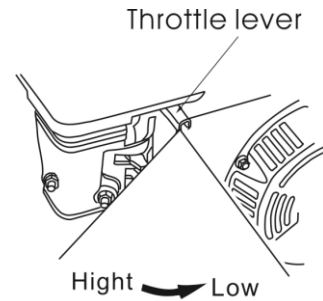

(Pic.8)

4. Start the engine

a). Rope handle Starter.

Push the engine switch to “ON”. (Pic. 9) Pull slightly the starting rope handle up until feeling anti-action, and then make a rapid pull. (Pic. 10)

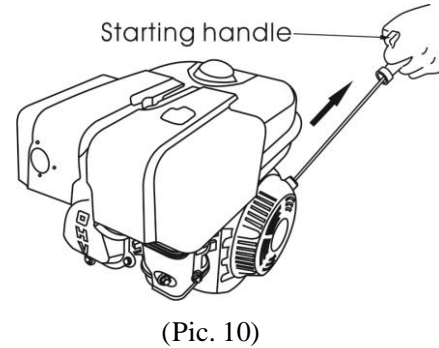
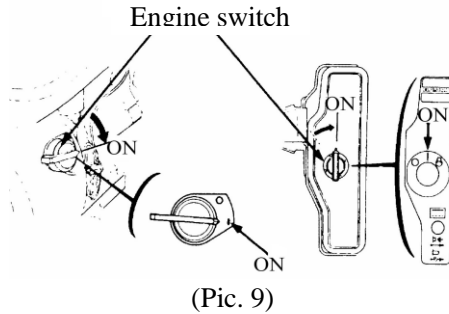

CAUTION

Releasing the handle suddenly may make it hitting the engine. Release the handle slowly conforming to its recoiling force.

2) Electric starter

Push the engine switch to “START” and remain there until the engine Start. (Pic. 11)

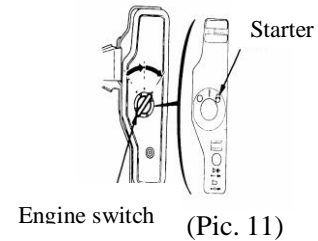

CAUTION

Use the engine switch not more than 5 second each time to avoid damage of the engine. Try once more 10 second later after last attempt failures.

Once the engine starts, reset the engine switch to “ON”.

OPERATION

1. Preheat the engine and push back the choke lever to “ON”.(Pic.12)

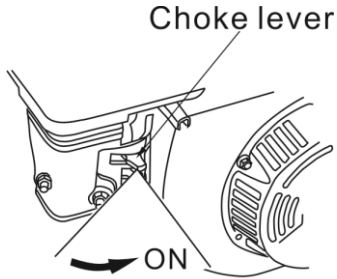

(Pic .12)

2. Set the throttle lever in proper position to ensure the engine runs at required velocity.(Pic.13)

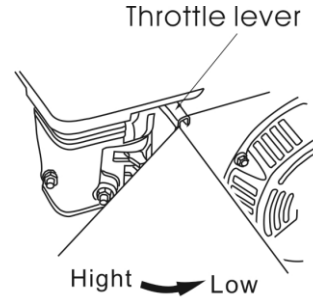

(Pic .13)

★ Engine Oil Alarm

The engine oil alarm is designed to alarm the user the fact that the engine oil in the crankcase is insufficient. Run with insufficient engine oil may damage the engine. Once oil level in the crankcase is too low, the engine oil alarm will stall the engine automatically to make it free of damage while the engine switch is still at “ON”.

CAUTION

If the engine still fails to work, check the engine oil level first before go to other check items.

Breaker (Electric start)

Breaker is used to protect the battery charging circuit. It will be disconnection when short circuit or battery polarity connects in wrong direction. (Pic .14)

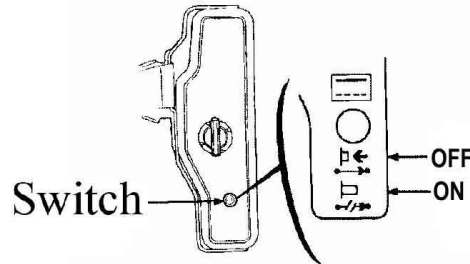

(Pic .14)

The green indicator would be light once the circuit off. If this happens, please find out the reason and solve it then press the button to recover the breaker.

★ Operating on Highlands

On highlands, the standard mixture ratio is relatively too big so the engine performance may be impaired while the fuel consumption may increase. This problem can be solved as follows: replace the main jet of carburetor with a smaller one, then, adjust the idly screw. If always using on highlands with a height above sea level of 1830 meters, ask your dealer for doing the job.

The engine power will decrease by about 3.5% with every 305 meters up in height; even the proper main jet is used. The output would be much lower if not adjust the jet.

CAUTION

The engine equipped with the main jet applicable to highlands may be damaged seriously in area below specified altitude, because its mixture ratio is too thin, output drops and the engine overheats for operation in low altitude area. In the case, ask your dealer to recover the engine to its normal technical status.

STOP

In an emergency, push the engine switch to “OFF” to stall the engine. Stop it in normal in the following sequence:

1. Push right the throttle valve lever to the bottom (Pic. 15).

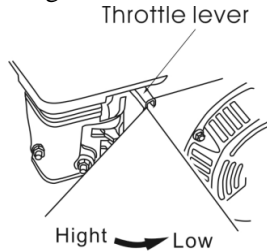

(Pic. 15)

2. Push the engine switch to “OFF” (Pic. 16)

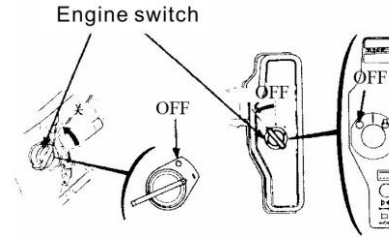

(Pic. 16)

3. Set the fuel switch to “OFF” (Pic. 17)

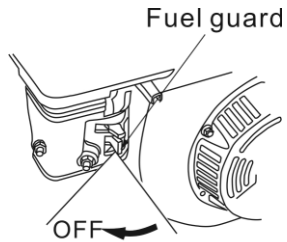

(Pic. 17)

EXHAUST CONTROL SYSTEM

With the engine running, carbon monoxide, oxide of nitrogen and hydrocarbon will produce, and in certain conditions, oxide of nitrogen and hydrocarbon will react chemically each other to make smoke while carbon monoxide is toxic, so exhaust control of them is very important. The company decreases the exhaust emissions by introducing poor-fuel carburetors and other devices into the engine to solve the problem.

To keep the exhaust of your engine within the standard exhaust emission values, pay attention to the following:

I. MAINTENANCE

Maintain the engine periodically in accordance with the Maintenance Schedule in the manual. The maintenance schedule is made out on the base of normal use in normal conditions, if using under heavy load, dusty or wet circumstances or in high temperature, more frequents maintenance will be necessary.

II. REPLACEMENT OF PARTS

We recommend that you should choose such parts, which are manufactured by our Co. or equivalent to these in quality as replacement ones. Replacement without so high quality may impair the exhaust control system in effectiveness.

III. MODIFYING

Modifying the exhaust control system may make actual exhaust emissions exceeding statutory limit values. Illegal modification is as follows:

1. Dismantle or modify any part of air inlet or outlet system.

2.Modify or take off speed-adjusting connection device or speed adjustment device to result in the engine's running or outside the set parameters.

IV.PROBLEMS AFFECTING EXHAUST EMISSIONS

1. Difficult starting or difficult stopping.
- 2.Unstable idling.
- 3.Give off black smoke or consume too much fuel.
- 4.Poor ignition sparks or sparks returned.
- 5.Ignition is too advanced.

Once you find any of above problems, contact your dealer for help.

MAINTENANCE

I. MAINTENANCE SCHEDULE

To keep the engine in a sound condition, the user should maintain it according to the table below:

Frequency	Items	Each time	Initial 1 month or 20 Hrs	Initial 3 month or 50 Hrs	Every 6 month or 100 Hrs	Every 1 years or 300 Hrs
Engine oil	Check oil level	△				
	Replace		△		△	
Reduction Gear oil	Oil level check	△				
	Replace		△		△	
Air cleaner	Check	△				
	Clean			△	△①★	
	Replace-clean					△★★
Deposit cup	Clean				△	
Spark plug	Clean, adjust				△	
	Replace					△
Spark eliminator	Clean				△	
Idling	Check-adjust					△②
Valve clearance	Check-adjust					△②
Fuel tank & Fuel filter	Clean					△②
Fuel supply line	Check	Every two years (do a replacement if necessary)				

NOTES

★: Only for inside-ventilating double-core carburetors.

★★: Only for paper core air cleaners.

1) More often than that in the schedule if in dusty circumstances.

2) The items should be done by your dealer you are specially trained and is well equipped with tools.

II . METHOD

1. Replacement of Engine Oil

A still hot engine is helpful to drain out the engine oil in the crankcase rapidly and entirely. (Pic. 18)

1) Turn off the oil filler cap and drain plug to drain engine oil thoroughly. Reinstall the drain plug and screw in securely.

2) Fill the specified engine oil to the upper lever mark..

3) Reinstall the oil filler cap.

Engine oil capacity of the crankcase is 0.6 liters.

Engine oil capacity of the 1/2 reduction gearbox is 0.5 liters.

Engine oil capacity of the 1/6 reduction gearbox is 0.15 liters.

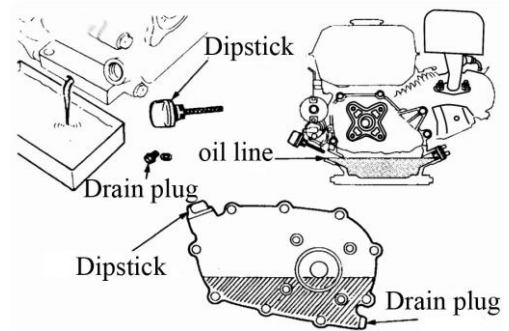

(Pic. 18)

NOTE

Do not dump oil containers or discarded engine oil into rubbish boxes or onto the ground. For the sake of environmental protection, we suggest you take in discarded engine oil with a closed container and bring to local recycling station.

2. Service of Air Cleaner

A dirty air cleaner may block enough air's flowing into the carburetor. To keep the carburetor in Good working conditions, please service the air cleaner periodically. If operating the engine in extremely dusty area, the job should be done more often.

WARNING

Never clean the air cleaner core in gasoline or low flash-point detergents, or explosion may happen.

CAUTION

Never run the engine without an air cleaner, or air with dirt and dust may enter the engine so speed the engine's wear.

- 1) Turn off the air cleaner's cap, and then separate the filter to check the air cleaner filter whether worn out or broken. If there is something wrong with it, please replace it.
- 2) Clean with home detergents and warm water (or non-flammable of high flash-point cleaning solvents) and dry up.
- 3) Soak in clean engine oil until saturated. Squeeze out excess oil, otherwise, the engine will discharge smoke in starting stage.
- 4) Empty the oil in the air cleaner, Use non-flammable or high flash-point cleaning solvents to clean the dusty, and

then dry-up the air cleaner box.

5)install the air cleaner filter and cover to original position.

3.Washing of Deposit Cup.

Set the fuel switch at “OFF”, remove the deposit cup and O-ring.

Wash them in non-flammable or high flash-point cleansing solvents, and then dry them up, at last, carry out reinstallation. Set the fuel switch to “ON” and check for leaks. (Pic. 19)

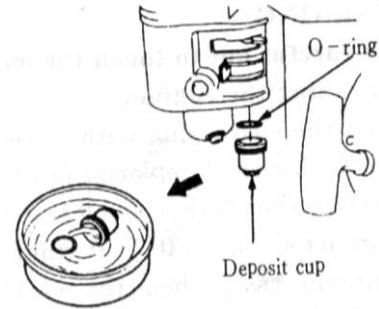

(Pic. 19)

⚠ WARNING

- Gasoline is extremely flammable and explosive in certain conditions. Keep cigarette, sparks and open flames away.
- After reinstalling the deposit cup, check it for leakage and make sure the area around the engine is dry enough.

4. Spark Plug

Spark plug type: F6TC or BPR6ES (NGK)

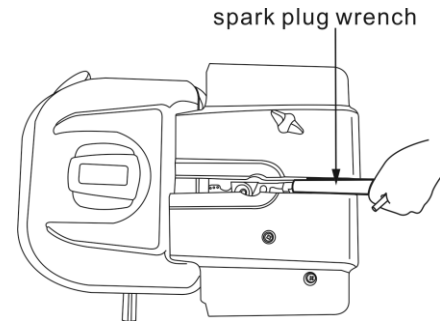

(Pic. 20)

Proper spark plug clearance and without deposit around the spark plug ensure the engine's normal running.

1) Remove the spark plug by means of spark plug wrench. (Pic. 20)

⚠ WARNING

Be careful not to touch the muffler during or just after running the engine.

2) Clean the spark plug with a steel brush. If the insulator is damaged, replace the spark plug instead.

3) Measure the spark plug clearance with a feeler. The clearance should be 0.7~0.8mm, If adjustment is necessary, bend the side electrode carefully. (Pic. 21)

4) Check if the spark plug gasket is in good conditions, or replace with a new one.

5) Screw on the spark plug to the bottom first by hand and then tighten it up by a spark plug wrench. (Pic. 22)

If a new spark plug is used, twist 1/2 more turns after impacting the gasket; if reinstall the original one, just twist 1/8~1/4 more turns.

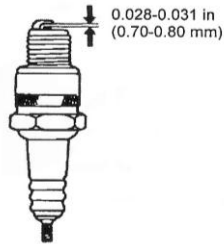

(Pic. 21)

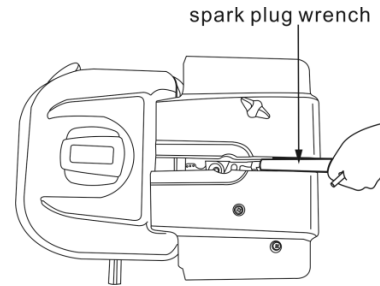

(Pic. 22)

CAUTION

- The spark plug must be tightened securely, or it may become very hot to damage the engine.
- Only use recommended spark plug or the equivalent. Incorrect heat range of the spark plug may damage the engine.

5. Spark Eliminator (Option) (Pic. 23)

The spark eliminator should be serviced at least once every 100 hour's operation so as to keep it in a sound condition.

⚠ WARNING

The muffler is very hot during running the engine and even a long Time after stopping. Never touch it, or you may get burns. Service After the engine cools down.

- Unscrew two nuts M4, and remove the exhaust elbow from the engine body.
- Turn off four screws M5 from the muffler guard and take out the latter.
- Turn off screw M4 from the spark eliminator and separate it from the muffler.

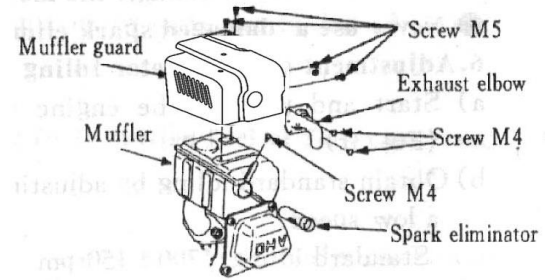

(Pic. 23)

- d) Clear away carbon deposit from the spark eliminator mesh with a brush.
- e) Reinstall the spark eliminator in reverse order of removal. (Pic. 24)

CAUTION

- Be careful not to damage the mesh of the spark eliminator.
- Never use a damaged spark eliminator.

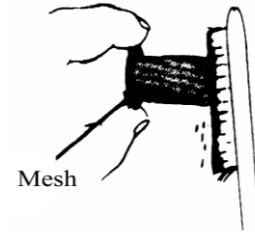

(Pic. 24)

6.Adjustment of Carburetor Idling

- a) Start and preheat the engine until arriving at its normal working temperature.
- b) Obtain standard idling by adjusting the throttle fixing screw under the engine runs at a low speed. (Pic. 25)

Standard idling: 1500 ± 100 rpm

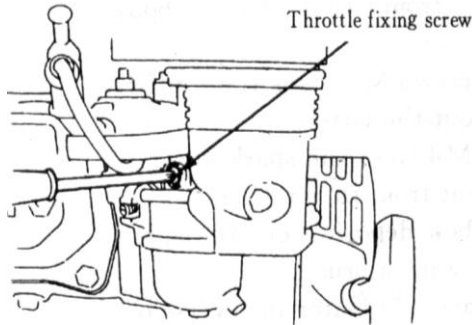

(Pic. 25)

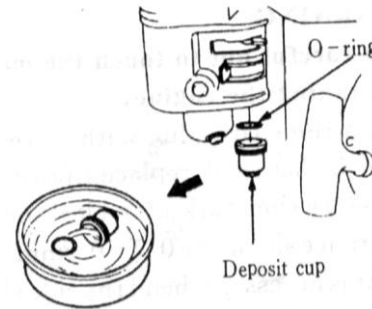

(Pic. 26)

TRANSPORT, STORAGE AND REMOVAL FROM STORAGE

I. TRANSPORT

Transport with the fuel switch turned off. Transport or store the engine it is cool so as to avoid getting burns or fire. If the engine is not kept in use for a long time, be sure to store it properly.

- 1) Make sure the storage area is dry and free of dust.
- 2) Make sure to put the oil (which in the gasoline tank and carburetor) into another proper container.

CURTION

Fuel is extremely flammable and explosive under certain conditions. Keep cigarette, open flames and sparks away from operating site.

- 1) Replace the engine oil. (Pic. 26)
- 2) Disconnect the spark plug. Fill a spoon of fresh engine oil from the spark plug mount hole into the cylinder. Rotate the engine to distribute engine oil evenly, followed by fitting the spark plug to original position.
- 3) Pull the starting rope slowly until feel a slight anti-action, and then keep pulling so as to align the arrow of the starting sleeve with the hole of the starter. At this time, both the inlet and outlet valves are closed so to help prevent the engine inside from rusting.
- 4) Electric starter: disconnect the battery and store in dry and cool area. Charge once every month.
- 5) Cover the engine so keep dust away.

TROUBLESHOOTING

I . STARTING ENGINE DIFFICULTLY

TROUBLE	CAUSE	REMEDY
1. Something wrong with the fuel system 2. Fuel supply is blocked or on fuel. ▲ Normal cylinder compression ▲ Normal spark	There is no enough fuel in fuel tank or fuel cock is closed	Fill fuel, open fuel cock
	Air vent in the filler cap is clogged.	Dredge air vent
	Fuel cock is clogged.	Clean first and then dredge
	Improper or clogged main jet	Readjust or clean, blow to get through
	Needle valve is closed improperly or start hole is clogged	Dismantle needle valve and repair, clean, blow to get through
	Floater is damaged or sticking	Repair floater
1. Something wrong with the fuel system ▲ Normal cylinder compression ▲ Normal spared ▲ Fuel flows easily and smoothly	Fuel is filthy or deteriorated	Replace
	There is filthy or deteriorated	Replace
	Too much fuel in engine cylinder	Drain extra fuel, dry up spark plug electrodes
	Wrong fuel brand	Select proper fuel brand corresponding with Requirements

TROUBLE	CAUSE	REMEDY
1. Spark plug is in bad condition ▲ Normal cylinder compression ▲ Normal fuel supply ▲ Normal high-pressure coil spark	Too much carbon fouling and dirt around electrodes	Clear away
	Electrodes are burn damaged seriously or insulators damaged	Replace spark plug
	Improper electrodes gap	Adjust to proper value
1. No high-pressure coil spark ▲ Normal cylinder compression ▲ Normal fuel supply ▲ Normal spark plug	High-pressure coil is damaged	Replace
	Ignition coil damaged	Replace

⚠ WARNING

- When testing the spark plug, never hold the high- voltage wire of the spark plug with wet hand.
- Make sure there is no spilled fuel outside the engine and that the spark plug isn't dipped with fuel.
- To prevent fire, keep sparks for away from the spark plug mount hole.

Once you find any of above problems, contact the authorization entitle to the dealer of the privilege helps for you.

TROUBLE	CAUSE	REMEDY
1. Poor cylinder compression ▲ Normal fuel supply system ▲ Normal ignition system	Piston ring is so worn to over its wear limit	Replace a set of piston rings
	Piston ring is sticking	Clear up carbon fouling
	Piston ring is broken	Replace
	Spark plug is not installed tighten or without a gasket	Tighten with a gasket in
	Air leakage between cylinder block and cylinder	Check cylinder gasket and the flatness of the surface by which cylinder block on-tacting with cylinder head; tighten cylinder bolts in the order to stipulated torque
	Air leakage in valve	Check valve clearance and tightness, repair if necessary

II. LOW GASOLINE ENGINE POWER OUTPUT

TROUBLE	CAUSE		REMEDY
When turning throttle greater, speed increase responds slowly or speed is decreased even engine stops	Ignition	Incorrect ignition time	Readjust ignition advance angle
	Fuel supply system	Air in fuel line of fuel line clogged.	Exhaust air or dredge fuel line
		Main jet is not adjusted Properly.	Readjust
		In carburetor, needle valve hole and main jet clogged	Clean and blow to get through
		Fuel cock is clogged up	Clean, replace Damage part.
		Too much carbon fouling in combusting chamber	Clear away
		Air cleaner is clogged up.	Clean filter element

TROUBLE	CAUSE		REMEDY
Do.	Do.	Intake pipe is leaking	Replace or replace it
	Poor compression	Piston or cylinder or piston ring is worn.	Replace it with a new one
		Air leakage from the surface by which cylinder block contacting with cylinder head.	Replace cylinder gasket
		Too big or too small valve clearance.	Adjust it
		Valve tightness is poor	Repair

III. GASOLINE ENGINE CANNOT RUN SMOOTHLY

TROUBLE	CAUSE	REMEDY
Engine is pinking	Piston, cylinder or piston ring is worn excessively.	Replace the worn
	Piston pin and piston pin hole are worn excessively.	Replace piston or piston pin
	Tie rod small head is worn excessively.	Replace tie rod
Do.	Roller bearing for crankshaft main shaft is worn	Replace roller bearing
TROUBLE	CAUSE	REMEDY
Abnormal combustion	Engine is too hot	Shoot trouble
	Too much carbon fouling in combustion chamber	Clear away
	Improper gasoline brand or low gasoline quality	Replace with qualified gasoline
Engine cannot start because of spark lacking	There is water in floater room	Clean
	Improper spark plug electrodes Clearance	Adjust
	Incorrect ignition time	Readjust
	Something wrong with induced coil, And so on	Check and replace Damaged parts

IV. STOP SUDDENLY WHEN RUNNING

TROUBLE	CAUSE		REMEDY
Stop suddenly	Fuel supply system	Fuel is used up	Fill fuel
When running	Do.	Carburetor is clogged	Check fuel line and dredge
		Floater is leaking	Repair
		Needle valve sticks	Dismantle floater chamber And eliminate it
TROUBLE	CAUSE		REMEDY
When running	Ignition system	Spark plug is struck through, or short-circuited by carbon deposit	Replace spark plug
		Side electrode of spark plug is dropped out	Replace spark plug and remove the dropped object
		Hi-voltage wire is dripped out	Connect it
		Engine oil in the crankcase is insufficient	Add engine oil until it arrives the upper level
Do.	Do.	Ignition coil is struck through to be short-circuited	Replace ignition coil with new one

		Parking wire is located on the engine body	Find out meeting and insulate
	The other	Cylinder is pulled considerably, valve falls off	Repair or replace damaged parts

V. GASOLINE ENGINE IS EXCESSIVELY HOT

TROUBLE	CAUSE	REMEDY
Gasoline engine is excessively	Improper ignition time	Adjust ignition advance angle properly
	Insufficient engine oil supply	Refill sufficient engine oil
	Exhaust pipe is clogged	Dredge exhaust pipe
Do.	Flow guard is leaking	Repair leakages
	Dirt or something like the fill up among air cooling fins	Clear away dirt or something like this
	Cooling fan is loosen, losing function	Reinstall it well
	Cylinder, piston or piston ring is worn, Resulting in air flow between cylinder and crankcase	Replace tie rod
	Tie rod deformation makes piston and Cylinder bushing side wear.	Replace tie worn part
	Improper adjustment of engine speed produces excessive rotational speed	Readjust engine speed to proper value by speed regulator
	Bearing of crankshaft is burn out	Replace main bearing

NOTE: The gasoline engine should run under certain temperature. Generally, permitting temperature at the flow guard outlet is between 80~110°C, while the temperature of the crankcase is about 60°C under the magneto. If temperatures surpass the limits, it is an indication that gasoline engine is

excessive hot.

VI. THERE IS ABNORMAL NOISE WHEN ENGINE RUNNING

TROUBLE	CAUSE	REMEDY
There is noise of beating or piston slap is heard	Piston or piston ring or cylinder is worn	Replace the worn
	Tie rod or piston pin and piston pin hole is worn	Replace the worn
	Main bearing of crankshaft is worn	Replace
	Piston ring is broken	Replace
There is metal-beaten noise in abnormal combustion	Too much carbon deposit in combusting chamber	Clear away carbon deposit
	Too small electrodes clearance of spark plug	Adjust electrodes clearance properly
	Engine is flooded with fuel	Check relative parts such as carburetor
	Improper fuel brand	Replace fuel
	Engine is excessively hot	Shoot trouble
TROUBLE	CAUSE	REMEDY
The other	Improper valve clearance	Readjust valve clearance properly
	Fly wheel is not connected to crankshaft Tightly	Connect tightly

SPECIFICATIONS

I . MAIN SPECIFICATIONS

Model	62027/62029
Items	
L × W × H (mm)	380 × 312 × 360 <380 × 332 × 360>
Dry weight (kg)	16 <17.9 >
Engine type	4-stroke, OHV, single cylinder tilt 25 °
Displacement (cm ³)	212
Bore × stroke (mm)	70 × 55
Max. Power in theory (kW/r/min)	5.5(7.5PS)/3600
Power recommended (KW/r/min)	4.5(6.0PS)/3600
Max. Torque (N · m /r/min)	11.5/3000
Fuel consumes. (g/kWh)	395g/kwh
Cooling system	Force air - cooled
Ignition system	Non – transistorized ignition (TDI)
Spark plug type	F6TC, BPR6ES (NGK)
Out direction of power shaft	Counterclockwise

Date relating to Adjustment

Item	Date
Spark plug clearance	0.7~0.8mm
Carburetor idling	1500±100rpm
Valve clearance (cold engine)	Intake: 0.15 ±0.02mm; Exhaust: 0.20 ±0.02mm

NOTES

- Technical data vary with type of engine; therefore, they are subject to change without notice.
- Data in < > are suitable for engine which is equipped with reducer.

II. TIMING OF DISTRIBUTION

Intake valve opening: BTDC10 °;

Intake valve closing: ABDC20 °;

Exhaust valve opening: BBDC30 °;

Exhaust valve closing: ATDC10 °

III. TIGHTENING TORQUE OF IMPORTANT BOLTS

S/N	Item	Torque Value (N · m)
1	Cylinder head bolt	34
2	Flywheel bolt	118
3	Crankcase cover bolt	24
4	Connecting rod bolt	14

Electric Diagram (electric start)

ELECTRIC DIAGRAM (for electric-start type)

Bl	Black	Gr	Grey
Y	Yellow	R	Red
W	White	G	Green

Switch combination				
	IG	E	ST	BAT
OFF	○—○			
ON				
START			○—○	

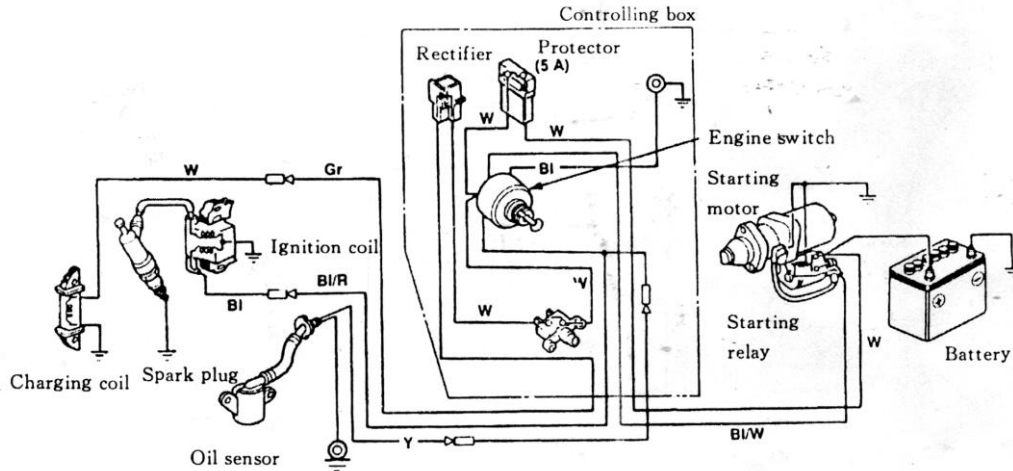

Except Electric Start Model, Different Model have different electric diagram.

ELECTRIC DIAGRAM

Bl	Black
Y	Yellow
G	Green

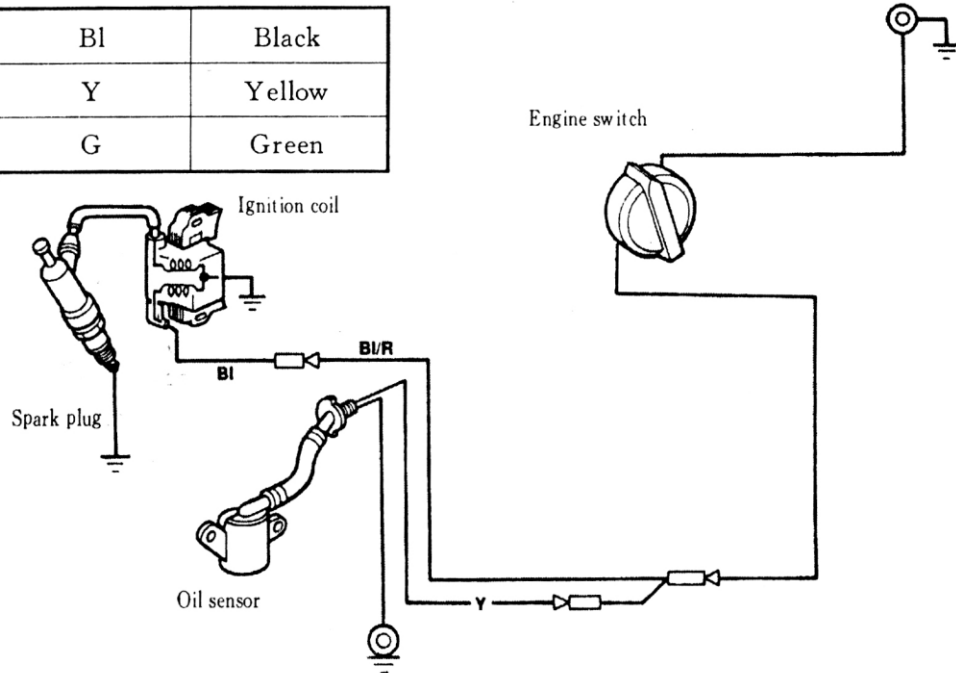

K-1583