

LOTOS TECHNOLOGY

Plasma Cutter LT5000D

www.uwelding.com



LOTOS®

Lotus Technology LT5000D Quick Setup

Instructions

Power plug wiring identification:

For either 110 or 220VAC, the GREEN wire with the yellow strip is ground wire. The other two wires are hot wires.



Figure 1.1

1. Wear a proper helmet (Figure 1.1) to protect your eyes from harmful plasma cutting arc radiation. Wear safety gloves to protect your hands during operation.

2. Connect the machine gas inlet (on the back of the machine, Figure 1.2) to an air compressor (Figure 1.3 & 1.4) and set the air pressure to 65 - 70 PSI. (The air regulator is optional as some air compressors provide air pressure control capability).

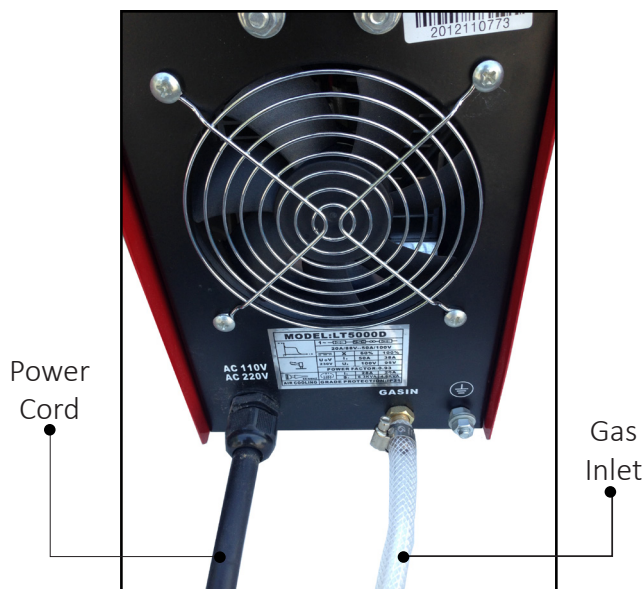

Figure 1.2



Figure 1.3

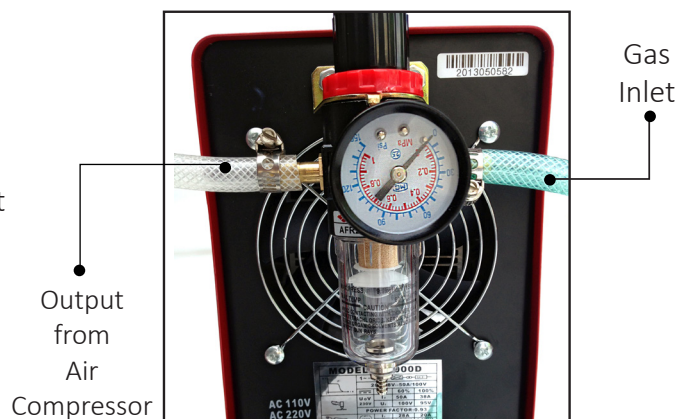

Figure 1.4

3. Connect your plasma cutting torch and ground cable to the front panel of the machine (Figure 1.5) .



Figure 1.5

4. Attach the ground clamp to the metal work piece that you plan to cut. Grind the metal to make sure the clamp is securely attached. Press the trigger of the torch and make sure there is air flow. Finally, move the torch head to the work piece and enjoy cutting!!
5. Change your consumables (tip, electrode, and cup) when they become worn out. The correct consumable type is LCON. The metal protector on the tip is also replaceable. All accessories and consumables can be purchased at www.uwelding.com or Lotos's authorized resellers.

Thank you for your business!

LOTOS TECHNOLOGY
POWERFUL, PORTABLE AND AFFORDABLE WELDING SOLUTIONS



Contact us:
1155 Tasman Drive
Sunnyvale, CA 94089

Tel: +1(408)739-2329
E-mail: sales@lotostechnology.com
<http://www.uwelding.com>

LOTOS Plasma Cutters User Manual

Version: 2.0, May 2014

copyright @ Lotos Technology

www.uwelding.com is operated by Lotos Technology



Table of Contents

Introduction	3
Overview	3
Audience	3
Safety Precautions	4
Overview	4
Caution Recommendations	4
Avoiding Fatal Electric Shock	4
Avoiding Harmful Smoke, Gases, and Vapors	4
Avoiding Harmful Arc Emissions/Rays	4
Avoiding Harmful Noises	4
Fire or Explosion	5
Burn Protection	5
Protecting Eyes from Flying Metal or Dirt	5
Pacemakers	5
Cylinder Handling	5
Equipment	6
General Overview	6
Main Characteristics	6
Specifications	6
Adjustor Diagram	9
Power Cord Plug Connection	9
Connecting Cables to Machine	10
Installations	11
Instruction Notes	13
Cutting Environment	13
Safety	13
Notes for Torch	13
Maintenance and Troubleshooting	13
Trouble Shooting Guide	14
Plug Wiring Instructions	15

**For more information and more of our products,
please visit our website at
<http://www.uwelding.com/>**

Introduction

Overview

Dear Valued Customer:

Thank you for purchasing a Lotos Technology plasma cutter! Feel free to check out our other products at www.uwelding.com.

The User Manual documents policies and procedures for proper operation of the equipment.

IMPORTANT: Be sure to review the contents of this manual before attempting to operate the equipment. This manual should be located where it can be easily referenced by all users of the machine.

Audience

This manual assumes that all individuals reading the manual and using the welder/cutter are able, qualified, and/or certified to operate this type of machinery.

Safety Precautions - Read Before Using

Overview

Protect yourself and others from injury — read and follow these precautions.

Caution Recommendations



CAUTION: Welding and arc cutting can cause bodily injury.

- Do NOT switch off the machine while machine is in operation for internal circuitry can be damaged.
- Connect the machine to a UL-approved outlet only. Do not hard wire the machine directly to the power source.
- Wear safety goggles at all times. This will darken the arc that is generated by the machine and protect your eyes from harmful rays.
- All machine operators should be technically certified for welding/cutting.

Avoiding Fatal Electric Shock



- Isolate yourself from both the earth and the work piece.
- Make sure that your working area is nonflammable and explosive-free.

Avoiding Harmful Smoke, Gases, and Vapors that can injure or kill.



Welding produces fumes and gases. Breathing these fumes and gases can be hazardous to your health.

Avoiding Harmful Arc Emissions/Rays that can burn eyes and skin.



Arc rays from the welding process produce intense visible and invisible rays that can burn eyes and skin. Sparks fly off from the weld.

- Wear appropriate clothing and a welding or cutting mask to protect your eyes and skin.
- Use appropriate screen or curtain to prevent emissions from reaching individuals near the work area.
- Ensure that your working area contains no flammable items; and that none are nearby. Caution: Welding and cutting spray can ignite.

Avoiding Harmful Noises that can damage hearing.



Noise from some processes can damage hearing.

- Wear protective earplugs while operating machine.

Welding or Cutting can cause Fire or Explosion.



Welding, cutting, and allied processes can cause fire or explosion if precautionary measures are not followed.

- Develop adequate procedures, and use proper equipment to do the job safely.

- Remove combustible materials from a sphere with a minimum radius of 35 feet around the work area or move the work to a location well away from combustible materials.

Burn Protection: HOT PARTS can cause serious burns.



The work piece and equipment get hot. The hot metal, hot work piece, and hot equipment can cause burns.

- Use approved helmets or hand shields that provide protection for the face, neck, etc.
- Wear approved safety goggles or glasses with side shields, even under your helmet.
- Wear dry, hole-free insulated gloves.

Protect eyes from FLYING METAL or DIRT.



• Welding, chipping, wire brushing, and grinding cause sparks and flying metal.

- Wear approved safety glasses with side shields, even under your welding helmet.

PACEMAKERS AND WELDING: MAGNETIC FIELDS can affect implanted devices.



Electric arc welding and cutting processes produce intense electric and magnetic (electromagnetic) fields. The function of pacemakers can be affected by strong electromagnetic fields.

- Persons with a pacemaker should not go near welding or cutting operations until they have consulted their doctors and obtained information from the manufacturer of the device.

CYLINDER HANDLING: it can explode if damaged.

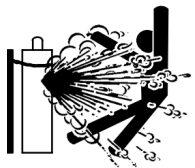

Shielding gas cylinders contain gas under high pressure. If damaged, a cylinder can explode. Be sure to treat gas cylinders carefully.

- Keep cylinders away from any welding or other electrical circuits.

- Protect compressed gas cylinders from excessive heat, mechanical shocks, physical damage, slag, open flames, sparks, and arcs.
- Install cylinders in an upright position by securing to a stationary support or cylinder rack to prevent falling or tipping.

If you encounter any difficulties during set up or operation:

- Consult this manual.
- Contact Lotos Customer Service by visiting <http://www.uwelding.com/about-us/contact-us/>.

Equipment

General Overview

The LT5000D employs state of the art inverter technology. 50/60Hz frequency is inverted to high frequency (over 100 KHz) by V-MOSFET followed by step down voltage and rectification current.

Using Pulse-Width-Modulation (PWM) technology, the inverter power supply generates powerful DC welding currents.

By applying switch power inverter technology, the dimensions and weight of the main transformer is significantly reduced; while efficiency is increased by 30%.

Main Characteristics

- Stabilization
- Reliability
- Portability
- Power efficiency and low noise output
- High cutting speed
- Smooth cuts

Suitable for stainless steel, alloy steel, mild steel, copper aluminum, and other metal materials; there are many applications for plasma cutters.

Specifications

Input voltages	110-220V, 1-PH, 50/60 Hz
Input current	110-220V, 1-PH, 20 A
Output current	10-50 A
Duty cycle @ 40°C (104°F)	60% @ 50A, 110V 60% @ 50A, 220V
Dimensions with handle	15'' (381mm) L; 6'' (152.4mm) W; 12'' (304.8mm) H
Weight w/ 8'11'' (2.7 m) torch	22.5 lbs (10.2 kg)
Gas Supply	Clean, dry, oil-free air
Recommended gas inlet flow rate / pressure	3.6 scfm @ 65 psi
Input power cable length	6' (1.8 m)
Power supply type	Inverter- IGBT
Accessories	Plasma Torch (9' 9") Plasma Consumables (installed on the torch head) Air Filter/Regulator Ground Clamp & Cable Connections, (like Air Hose etc.) User Manual

Torch Type

Torch Type	Model	Amperage	Consumable Type
3 prong LCON cutting torch	CL0103	50	LCON0120 LCON0140 LCON0190
Extended 3 prong LCON cutting torch	CL0203	50	LCON0220 LCON0240 LCON0290

Consumables Package

Part Number	Nozzle	Electrode	Shield Cup	Swirl Ring	Package Type	Total Pieces
LCON0120	LN01	LE01	LC01	LR01	LN01 x 10, LE01 x 10	20
LCON0140	LN01	LE01	LC01	LR01	LN01 x 10, LE01 x 10, LR01 x 10, LC01 x 10	40
LCON0190	LN01	LE01	LC01	LR01	LN01 x 40, LE01 x 20, LR01 x 20, LC01 x 10	90
LCON0220	LN02	LE02	LC02	LR02	LN02 x 10, LE02 x 10	20
LCON0240	LN02	LE02	LC02	LR02	LN02 x 10, LE02 x 10, LR02 x 10, LC02 x 10	40
LCON0290	LN02	LE02	LC02	LR02	LN02 x 40, LE02 x 20, LR02 x 20, LC02 x 10	90

Production Cut Chart

Material	Thickness*		Current
	inches	mm	amps
Mild Steel	10 gauge	3	50
	1/4	6	50
	3/8	10	50
	1/2	12	50
	5/8	16	50
Stainless Steel	10 gauge	3	50
	1/4	6	50
	3/8	10	50
	1/2	12	50
Aluminum	1/8	3	50
	1/4	6	50
	3/8	10	50
	1/2	12	50

*Production cut thickness are the results of Lotos' laboratory testing.

Production speeds are approximately 80% of maximum.

For optimum cut quality, cutting speeds may vary based on different cutting applications.



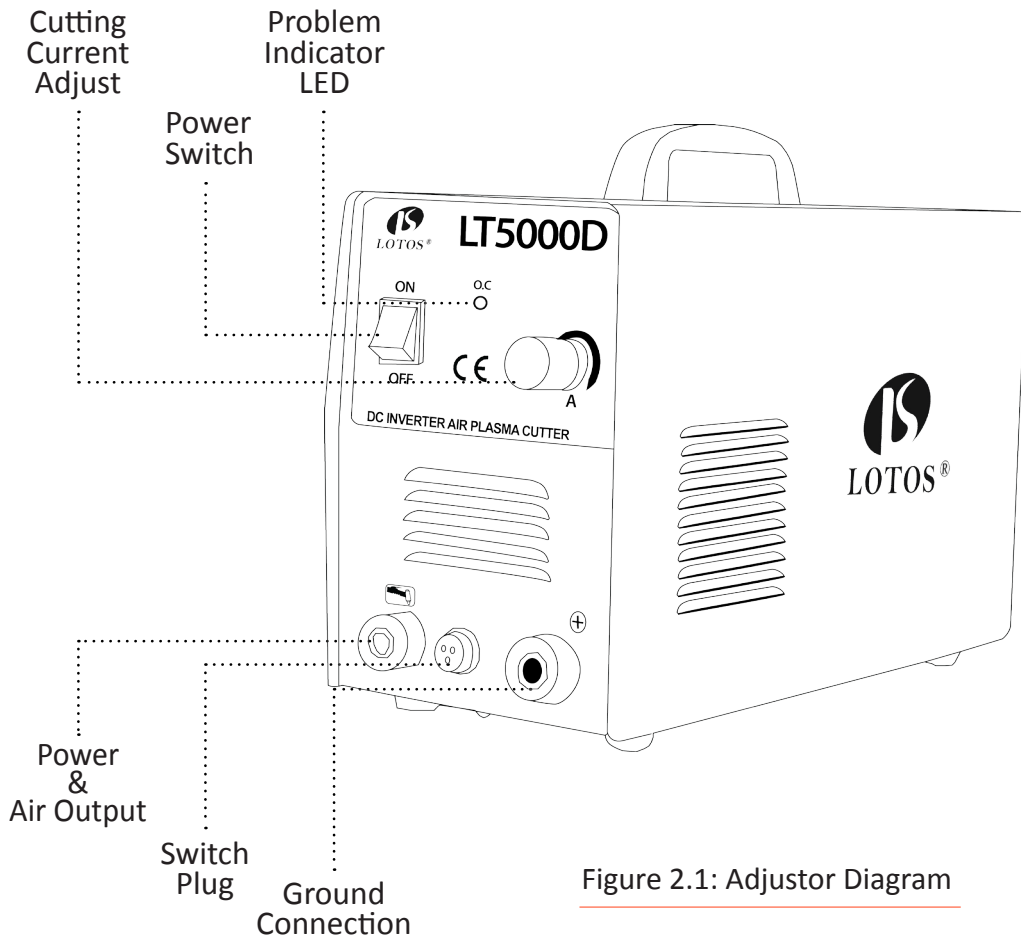

Figure 2.1: Adjustor Diagram



Figure 2.2: Power Cord Plug Connection

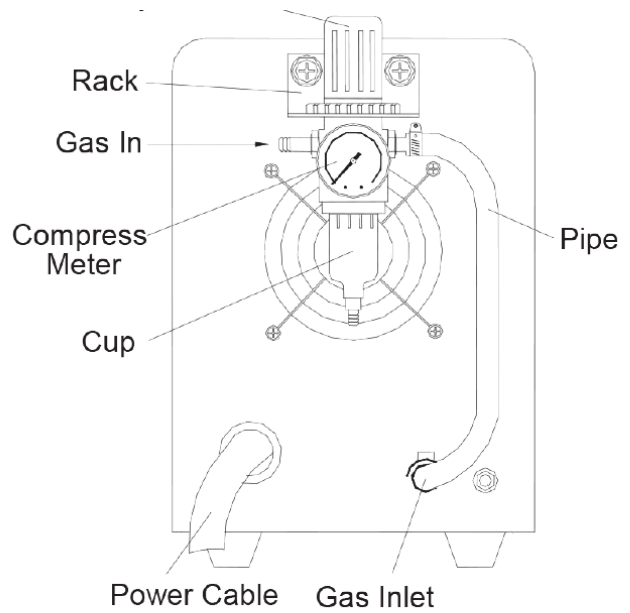

Figure 2.3: Air Regulator Configuration

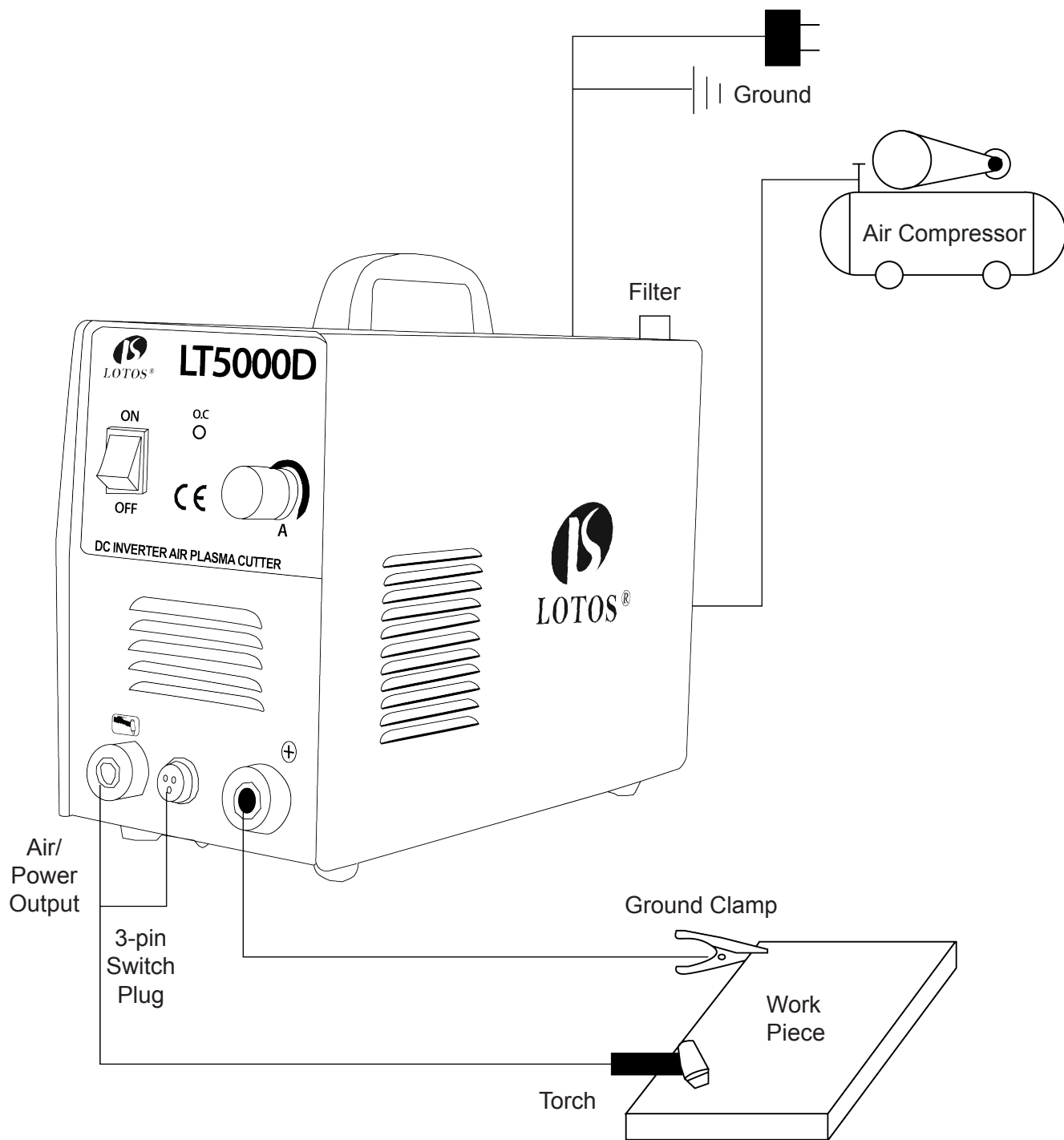

Figure 2.4: Connecting Cables to Machine

Installation

Power Cord Plug Connection (Figure 2.2)

1. Be sure to connect the power cord plug to the appropriate power voltage and use a proper hookup to avoid damage to internal circuitry. Typically, the ground wire is GREEN with a YELLOW stripe.
2. Ensure that the power cord is properly connected to the power switch to prevent oxidation. Make sure the power voltage is within the specified safety range.
3. Please refer to the Plug Wiring Instructions of this manual for detailed instructions on plug wiring.

Connecting the Cables to the Machine (Figure 2.4)

1. Properly connect the high pressure tube of pressed air to copper connector.
2. Ensure that copper screw at the opposite end of the torch is securely connected to the torch. To avoid gas leakage, turn screw clockwise until it locks into position. Connect the mobile plug at one end of the grounding cable pincer to the positive terminal located on the front panel; and then tighten.
3. Ensure that the air plug of the torch is connected to the switch connector on the panel. For cutters with pilot arc, connect the fork connector to the red terminal on the front panel.

Check-list before Operation

1. Ensure that the cutting machine is properly grounded.
2. Ensure that all connectors are connected appropriately and firmly.
3. Ensure that power voltages are correct.

Operating the Plasma Cutter

1. Make sure the machine on/off switch is in the off position. Plug the power cord plug into the outlet.
2. Connect air compressor with air regulator/filter.
3. Connect the ground clamp to your work piece. Caution: Rust or paint on the work piece could create an open circuit; therefore, the contact point should be cleaned thoroughly to ensure a good connection between clamp and work piece.
4. Turn on the power switch. The cooling fan should start to operate and the LED should come on. The front panel should show the machine's electrical current volume, and you can adjust it by turning the nob below the display.

Operating the Plasma Cutter

5. Adjust the air pressure on your air compressor to 60 – 65 psi for the machine.
6. Bring the torch tip into direct contact with your work piece edge or, for thicker cutting, over a pre-drilled pilot hole. Press the button on the torch to start cutting.
7. Ensure that the cutting current is appropriate and adequate for the machine based on the rated thickness of the cutter.

Note: Below is the consumable assembly on the torch head (Figure 3.1).

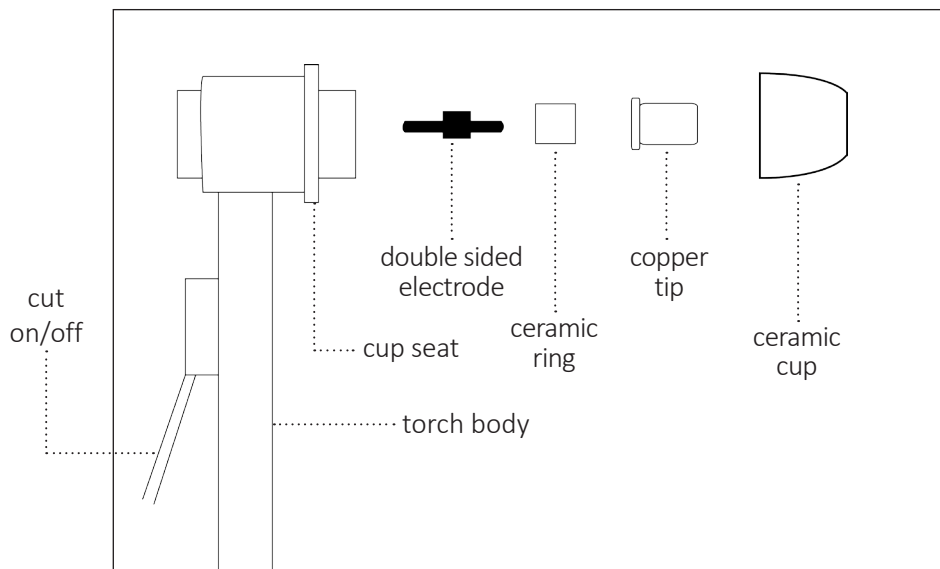

Figure 3.1

Instruction Notes

Cutting Environment

1. The cutting machine can perform in an environment where conditions are particularly harsh: it can withstand outside temperatures between 14 and 104 degrees Fahrenheit and a humidity level of up to 80%.
2. Please try to keep machine dry.

Safety

1. Working area MUST be adequately ventilated.
2. No over-load! Your machine can be damaged by over-loading.
3. No over-voltage! Internal circuitry can be damaged by over-voltage.
4. An internal heat-variable component is initialized if machine exceeds duty cycles. The cutting machine will stop working immediately, and an internal red diode will be lighted. Note: The user does not need to break the circuit; the fan will continue working in order to cool the machine. Once temperature is reduced to allowable range, machine can be operated again.

Notes for Torch

1. Ensure that the copper tip is not in direct contact with the work piece while cutting. To protect copper tip, torch should be inclined and maintain a distance of 1 mm from inter-hole of copper tip to the work piece.
2. If pilot arcing functions improperly, try to remove oxidization of the electrode on the torch with sand paper.

Maintenance and Troubleshooting

1. Dust created by compressed air should be removed regularly. If work environment is polluted with smoke and dust, daily maintenance is required.
2. Ensure adequate air pressure exists to protect internal components.
3. Check all connectors to ensure firm connections.
4. Protect machine from water or dampness.
5. When machine is not in use for a long period of time, it should be properly packed and stored in a dry environment.
6. Replace any worn consumables to avoid damage.

The following trouble shooting guide is for your reference only. Lotos Technology will NOT take any liability or responsibility for any injury or damage caused in such action(s). Always turn off electrical power and air supply before performing inspection and reconnection.

CAUTIONS: Only qualified technicians are authorized to undertake the repair of this equipment in the case of machine failure.

Faults	Possible Causes/Solutions
1. The power pilot light is off, the fan doesn't work, and there is no cutting voltage output.	<ol style="list-style-type: none"> 1. The power switch is broken. 2. There is no electrical power. 3. The input cable is short-circuited.
2. The power switch is on, the fan doesn't work. No voltage is indicated on the front panel.	<ol style="list-style-type: none"> 1. There is an improper connection to the plug or the plug is improperly connected to the 380V power supply, causing over-voltage protection. For latter case, wait for 8 minutes, reconnect to 220V power supply, and restart the machine. 2. The transformer is broken. 3. Voltage deficiency protection has been activated. 4. The wire from the switch to the bottom board has loosened. Tighten it. 5. The relay on the bottom board is damaged. Replace with a new relay.
3. The fan is on, the abnormal pilot light is not on, cannot start the arc.	Contact the manufacturer or certified service personnel.
4. The abnormal pilot light is off, no cutting voltage output.	<ol style="list-style-type: none"> 1. The welding cable is broken. 2. The ground is improperly connected to the work piece. 3. The "+" output terminal is not properly connected.
5. The problem pilot light is not on.	<ol style="list-style-type: none"> 1. The nozzle is oxidized or too far away. Remove the oxidization on the surface, or shorten the distance to 1 mm. 2. Otherwise, contact the manufacturer or certified service personnel.
6. The abnormal pilot light is on.	<ol style="list-style-type: none"> 1. Over-current protection may have initialized. Either wait for 2 or 3 minutes for the problem to go away, or turn off the power, wait until the abnormal pilot light is off, and restart (machine will recover automatically). 2. Otherwise, contact the manufacturer or certified service personnel.
7. The output current is not stable.	<ol style="list-style-type: none"> 1. Check connections on the front panel. 2. Otherwise, contact the manufacturer or certified service personnel.
8. The machine does not cut metal properly, or the arc is not stable.	<ol style="list-style-type: none"> 1. The input voltage is too low. 2. The ground cable is not well-connected. 3. The air pressure is too high or too low. 4. The nozzle and electrode of the torch do not fit well, or the input current is too low.

Plug Wiring Instruction

Do not attempt to wire or handle high voltage without proper training. Contact an electrician to help you install an electrical outlet or connect an electrical plug to your machine. Regardless of which machine you have, it will require power to operate properly. Do not assume you know which wires to connect until you read this manual completely as colors may be deceiving.

All of our machines are either 110VAC or 220VAC. The 110VAC machines will operate at 100V - 120VAC and 50-60Hz; the 220VAC machines will operate at 200-240VAC and 50-60 Hz. All machines are 1 phase unless otherwise stated. 1 phase means the power cord will have 1 ground wire and two hot wires (Figure 4.1.) Connecting these wires properly is very important, and improper wiring could cause damage and void product warranty.

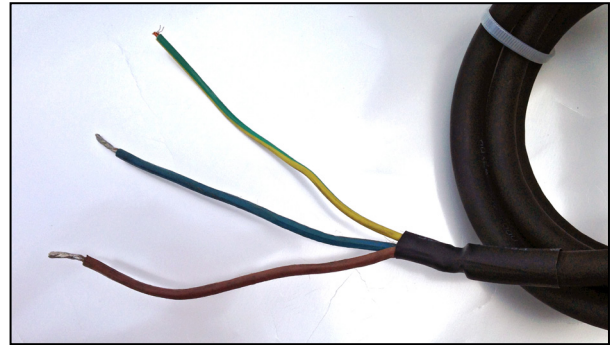

Figure 4.1

The ground wires on most machines are dark green. Some of them are green with a yellow twisted line in them. Some of the machines have blue, dark green, and dark red wires, and it may be difficult to differentiate which wire is ground because the blue and dark green looks similar. The best way to test for proper ground is to test the ohms between the machine chassis ground to the wire ground.

Note:

When ground wire is incorrectly connected, even the machine and the fan can turn on, but the machine would not operate properly.

You may need to consult with an expert to find the proper plug for your machine. First you will need to know the maximum amperage draw of your machine, which should be in your manual. Write it down and consult a qualified professional about which plug you will need.

The ground is the first wire you should connect in the plug. Next connect the two live wires. Generally it does not matter which one goes on which side. As a general rule of thumb, connect blue on the left and red on the right, or black on the left and white on the right.

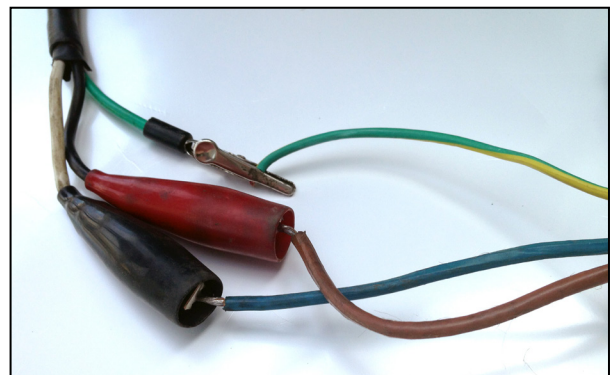

Figure 4.2

PLASMA CUTTERS

Plasma Tig Stick Combo



Powerful, Portable & Affordable
WELDING SOLUTION

CHECK OUT ALL OUR PRODUCTS AT
WWW.UWELDING.COM

