



MAGNUM[®]

TRUEAIRLESS[™]

Electric Airless Sprayer

OWNERS MANUAL

X5, X7, ProX17, ProX19, ProX21
3A3208B

EN



WARNING

FIRE AND EXPLOSION HAZARD

X5/X7 Models:

- Use only non-flammable or water-based materials, or non-flammable paint thinners. Do not use materials having flash points lower than 100° F (38° C). This includes, but is not limited to, acetone, xylene, toluene, or naphtha. For more information about your material, request Safety Data Sheet (SDS) from the supplier.
- Spraying flammable or combustible materials in a factory or fixed location must comply with NFPA 33 and OSHA 1910.94(c) requirements in the USA and with all similar local regulations in other countries.

***Not approved for use in explosive atmospheres or hazardous locations.
For portable airless spraying of architectural paints and coatings.***



Important Safety Instructions

Read all warnings and instructions in this manual, related manuals, and on the unit. Be familiar with the controls and the proper usage of the equipment. Save these instructions.

Before You Spray

Before You Spray

Review Warnings for Important Safety Information

Important! Read carefully and practice good safety habits.

Review Manual & Watch Videos

Scan QR code for Operational Video or go to magnum.graco.com/magop

Related Manuals

Gun: 312830 (SG)
ProXChange™ Pump: 3A3172 (ProX only)



Models

3000 psi (207 bar, 20.7 MPa) Maximum Working Pressure

	VAC	Model	Stand (Series)	Cart (Series)
 Intertek 110474 Certified to CAN/CSA C22.2 No. 68 Conforms to UL 1450	120 USA	X5	262800 (E) 17K437 (A)	
		X7		262805 (D)
		ProX17	17G177 (A) 17K438 (A)	17G178 (A)
		ProX19	17G179 (A)	17G180 (A) 17K439 (A)
		ProX21	17G181 (A)	17G182 (A)

Warnings

The following warnings are for the setup, use, grounding, maintenance, and repair of this equipment. The exclamation point symbol alerts you to a general warning and the hazard symbols refer to procedure-specific risks. When these symbols appear in the body of this manual or on warning labels, refer back to these Warnings. Product-specific hazard symbols and warnings not covered in this section may appear throughout the body of this manual where applicable.

WARNING



GROUNDING

This product must be grounded. In the event of an electrical short circuit, grounding reduces the risk of electric shock by providing an escape wire for the electric current. This product is equipped with a cord having a grounding wire with an appropriate grounding plug. The plug must be plugged into an outlet that is properly installed and grounded in accordance with all local codes and ordinances.

- Improper installation of the grounding plug is able to result in a risk of electric shock.
- When repair or replacement of the cord or plug is required, do not connect the grounding wire to either flat blade terminal.
- The wire with insulation having an outer surface that is green with or without yellow stripes is the grounding wire.
- Check with a qualified electrician or serviceman when the grounding instructions are not completely understood, or when in doubt as to whether the product is properly grounded.
- Do not modify the plug provided; if it does not fit the outlet, have the proper outlet installed by a qualified electrician.
- This product is for use on a nominal 120V circuit and has a grounding plug similar to the plugs illustrated below.

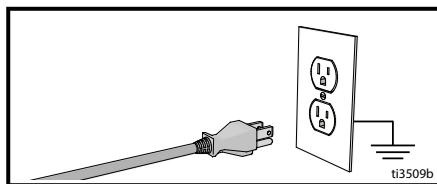

- Only connect the product to an outlet having the same configuration as the plug.
- Do not use an adapter with this product.

Extension Cords:

- Use only a 3-wire extension cord that has a grounding plug and a grounding receptacle that accepts the plug on the product.
- Make sure your extension cord is not damaged. If an extension cord is necessary use 12 AWG (2.5mm²) minimum to carry the current that the product draws.
- An undersized cord results in a drop in line voltage and loss of power and overheating.

Conductor Size		Length
AWG (American Wire Gauge)	Metric	Maximum
16	1.5 mm ²	25 ft. (8 m)
12	2.5 mm ²	50 ft. (15 m)

WARNING
**FIRE AND EXPLOSION HAZARD**

Flammable fumes, such as solvent and paint fumes, in work area can ignite or explode. To help prevent fire and explosion:

**X5/X7 Models:**

- Do not spray or clean with materials having flash points lower than 100°F (38° C). Use only non-flammable or water-based materials, or non-flammable paint thinners. For complete information about your material, request the Safety Data Sheet (SDS) from the material distributor or retailer.
- Do not spray combustible materials near an open flame or sources of ignition such as cigarettes, motors, and electrical equipment.
- Do not spray combustible liquids in a confined area.

**ProX Models:**

- Do not spray flammable or combustible materials near an open flame or sources of ignition such as cigarettes, motors, and electrical equipment.
- Do not spray flammable or combustible liquids in a confined area.

All Models:

- Paint or solvent flowing through the equipment is able to result in static electricity. Static electricity creates a risk of fire or explosion in the presence of paint or solvent fumes. All parts of the spray system, including the pump, hose assembly, spray gun, and objects in and around the spray area shall be properly grounded to protect against static discharge and sparks. Use Graco conductive or grounded high-pressure airless paint sprayer hoses.
- Verify that all containers and collection systems are grounded to prevent static discharge. Do not use pail liners unless they are anti-static or conductive.
- Connect to a grounded outlet and use grounded extensions cords. Do not use a 3-to-2 adapter.
- Do not use a paint or a solvent containing halogenated hydrocarbons.
- Keep spray area well-ventilated. Keep a good supply of fresh air moving through the area.
- Sprayer generates sparks. Keep pump assembly in a well ventilated area a least 20 feet (6.1 m) from the spray area when spraying, flushing, cleaning, or servicing. Do not spray pump assembly.
- Do not smoke in the spray area or spray where sparks or flame is present.
- Do not operate light switches, engines, or similar spark producing products in the spray area.
- Keep area clean and free of paint or solvent containers, rags, and other flammable materials.
- Know the contents of the paints and solvents being sprayed. Read all Safety Data Sheets (SDSs) and container labels provided with the paints and solvents. Follow the paint and solvents manufacturer's safety instructions.
- Fire extinguisher equipment shall be present and working.

WARNING



SKIN INJECTION HAZARD

High-pressure spray is able to inject toxins into the body and cause serious bodily injury. In the event that injection occurs, **get immediate surgical treatment**.

- Do not aim the gun at, or spray any person or animal.
- Keep hands and other body parts away from the discharge. For example, do not try to stop leaks with any part of the body.
- Always use the nozzle tip guard. Do not spray without nozzle tip guard in place.
- Use Graco nozzle tips.
- Use caution when cleaning and changing nozzle tips. In the case where the nozzle tip clogs while spraying, follow the **Pressure Relief Procedure** for turning off the unit and relieving the pressure before removing the nozzle tip to clean.
- Equipment maintains pressure after power is shut off. Do not leave the equipment energized or under pressure while unattended. Follow the **Pressure Relief Procedure** when the equipment is unattended or not in use, and before servicing, cleaning, or removing parts.
- Check hoses and parts for signs of damage. Replace any damaged hoses or parts.
- This system is capable of producing 3000 psi. Use Graco replacement parts or accessories that are rated a minimum of 3000 psi.
- Always engage the trigger lock when not spraying. Verify the trigger lock is functioning properly.
- Verify that all connections are secure before operating the unit.
- Know how to stop the unit and bleed pressure quickly. Be thoroughly familiar with the controls.



EQUIPMENT MISUSE HAZARD

Misuse can cause death or serious injury.

- Always wear appropriate gloves, eye protection, and a respirator or mask when painting.
- Do not operate or spray near children. Keep children away from equipment at all times.
- Do not overreach or stand on an unstable support. Keep effective footing and balance at all times.
- Stay alert and watch what you are doing.
- Do not operate the unit when fatigued or under the influence of drugs or alcohol.
- Do not kink or over-bend the hose.
- Do not expose the hose to temperatures or to pressures in excess of those specified by Graco.
- Do not use the hose as a strength member to pull or lift the equipment.
- Do not spray with a hose shorter than 25 feet.
- Do not alter or modify equipment. Alterations or modifications may void agency approvals and create safety hazards.
- Make sure all equipment is rated and approved for the environment in which you are using it.



ELECTRIC SHOCK HAZARD

This equipment must be grounded. Improper grounding, setup, or usage of the system can cause electric shock.

- Turn off and disconnect power cord before servicing equipment.
- Connect only to grounded electrical outlets.
- Use only 3-wire extension cords.
- Ensure ground prongs are intact on power and extension cords.
- Do not expose to rain. Store indoors.



WARNING



PRESSURIZED ALUMINUM PARTS HAZARD

Use of fluids that are incompatible with aluminum in pressurized equipment can cause serious chemical reaction and equipment rupture. Failure to follow this warning can result in death, serious injury, or property damage.

- Do not use 1,1,1-trichloroethane, methylene chloride, other halogenated hydrocarbon solvents or fluids containing such solvents.
- Do not use chlorine bleach.
- Many other fluids may contain chemicals that can react with aluminum. Contact your material supplier for compatibility.



MOVING PARTS HAZARD

Moving parts can pinch, cut, or amputate fingers and other body parts.

- Keep clear of moving parts.
- Do not operate equipment with protective guards or covers removed.
- Pressurized equipment can start without warning. Before checking, moving, or servicing equipment, follow the **Pressure Relief Procedure** and disconnect all power sources.



TOXIC FLUID OR FUMES HAZARD

Toxic fluids or fumes can cause serious injury or death if splashed in the eyes or on skin, inhaled, or swallowed.

- Read MSDSs to know the specific hazards of the fluids you are using.
- Store hazardous fluid in approved containers, and dispose of it according to applicable guidelines.



PERSONAL PROTECTIVE EQUIPMENT

Wear appropriate protective equipment when in the work area to help prevent serious injury, including eye injury, hearing loss, inhalation of toxic fumes, and burns. This protective equipment includes but is not limited to:

- Protective eyewear, and hearing protection.
- Respirators, protective clothing, and gloves as recommended by the fluid and solvent manufacturer.

CALIFORNIA PROPOSITION 65

This product contains a chemical known to the State of California to cause cancer, birth defects or other reproductive harm. Wash hands after handling.

ProX Cart Models

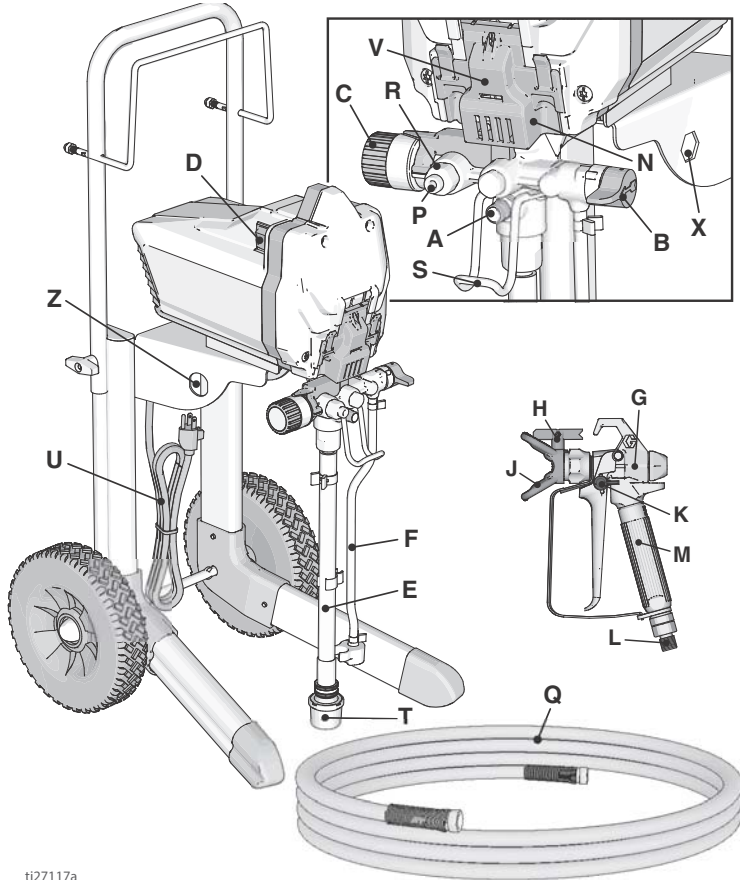

ti27117a

A	PushPrime Button
B	Prime/Spray Valve
C	Pressure Control Knob
D	ON/OFF Switch
E	Suction Tube
F	Drain Tube (with diffuser)
G	Airless Spray Gun
H	Reversible Spray Tip
J	Tip Guard
K	Gun Trigger Lock
L	Gun Fluid Inlet Fitting
M	Gun Fluid Filter (inside handle)
N	ProXChange Pump (behind Easy Access Door)

P	Pump Fluid Outlet Fitting (airless hose connection)
Q	Airless Hose
R	InstaClean Fluid Filter (inside fluid outlet)
S	Pail Hanger
T	Inlet Strainer
U	Power Cord
V	Easy Access Door
X	Pump Removal Tool
Z	Inlet Valve Removal Tool
	Model/Serial Tag (Not shown, located on bottom of unit.)
See Quick Reference , page 28 for more information.	

Quick Reference

Page 10	Name	Description
A	Prime/Spray Valve	<ul style="list-style-type: none"> In PRIME position directs fluid to drain tube. In SPRAY position directs pressurized fluid to paint hose. Automatically relieves system pressure in over-pressure situations.
B	PushPrime Button	Taps the inlet ball when pushed to loosen it.
C	Pressure Control Knob	Increases (clockwise) and decreases (counter-clockwise) fluid pressure in pump, hose, and spray gun. To select function, align symbol on pressure control knob with setting indicator, page 13.
D	ON/OFF Switch	Turns sprayer ON and OFF.
E	Suction Tube	Draws fluid from paint pail into pump.
F	Drain Tube	Drains fluid in system during priming and pressure relief.
G	Airless Spray Gun	Dispenses fluid.
H	Reversible Spray Tip	<ul style="list-style-type: none"> Atomizes fluid being sprayed, forms spray pattern and controls fluid flow according to hole size. Reverse position unclogs plugged tips without disassembly.
J	Tip Guard	Reduces risk of fluid injection injury.
K	Gun Trigger Lock	Prevents accidental triggering of spray gun.
L	Gun Fluid Inlet Fitting	Threaded connection for paint hose.
M	Gun Fluid Filter	Filters fluid entering spray gun to reduce tip clogs.
N	Pump	Pumps and pressurizes fluid and delivers it to paint hose.
P	Pump Fluid Outlet Fitting	Threaded connection for airless hose.
Q	Airless Hose	Transports high-pressure fluid from pump to spray gun.
R	InstaClean™ Fluid Filter (ProX only)	<ul style="list-style-type: none"> Filters fluid coming out of pump to reduce tip plugging and improve finish. Self cleans only during pressure relief.
S	Pail Hanger	For transporting pail by its handle.
T	Inlet Strainer	Prevents debris from entering pump.
U	Power Cord	Plugs into power source.
V	Easy Access Door (ProX only)	Easy Access Door permits quick access to the pump. Open pump door by pulling out on the tabs while sliding door up.
W	Suction Tube Drip Cup	Holds the suction tube during transport to catch drips.
X	Pump Removal Tool (ProX only)	Cut out in the frame provide the tools to quickly remove the pump packing without additional tools.
Z	Inlet Valve Removal Tool (ProX only)	Cut out in the frame provide the tools to quickly remove the inlet valve without additional tools.
	Power Flush Attachment	Connects garden hose to suction tube for power flushing water-based fluids.

Setup

Setup

When unpacking sprayer for the first time or after long term storage perform setup procedure.

Assemble Your Sprayer

1. Connect Graco airless hose to fluid outlet. Use wrench to tighten securely.

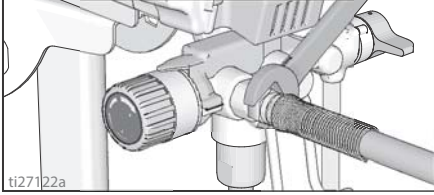

2. Connect other end of hose to gun.

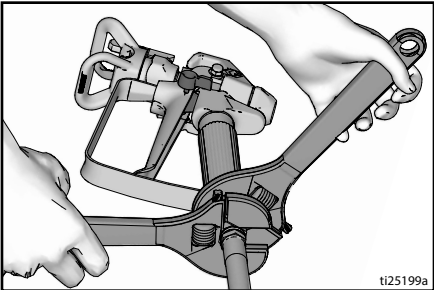

3. Use two wrenches to tighten securely. If hose is already connected, make sure connections are tight.
4. Engage trigger lock.

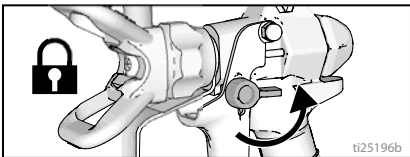

5. Remove tip guard. Be careful tip seal may fall out when tip guard is removed.

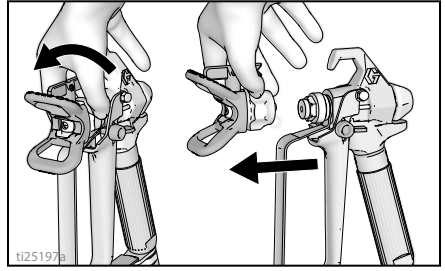

6. Turn pressure control knob all the way left (counter-clockwise) to lowest setting.

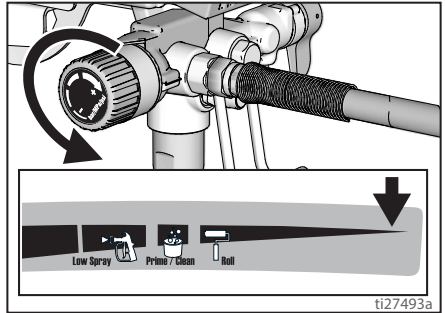

7. After long term storage check inlet strainer for clogs and debris.

Strain the Paint

Previously opened paint may contain dried paint or other debris. To avoid priming problems and spray tip clogs it is recommended to strain the paint before using. Paint strainers are available where paint is sold. Stretch a paint strainer over a clean pail and pour the paint through the strainer to capture any dried paint and debris before spraying.



Start Up

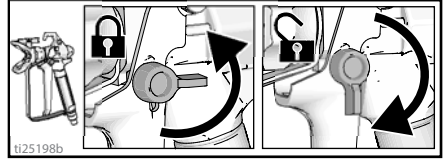

Pressure Relief Procedure



Follow the Pressure Relief Procedure whenever you see this symbol.

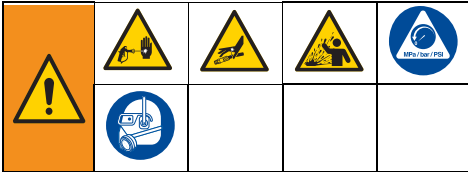

This equipment stays pressurized until pressure is manually relieved. To help prevent serious injury from pressurized fluid, such as skin injection or splashed fluid, follow the **Pressure Relief Procedure** whenever sprayer is stopped and before sprayer is cleaned or checked, and before equipment is serviced.

1. Turn ON/OFF switch to the **OFF** position.

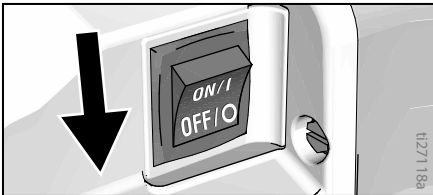

2. Engage the trigger lock. Always engage the trigger lock when sprayer is stopped to prevent the gun from being triggered accidentally.

3. Turn pressure control knob to lowest setting.

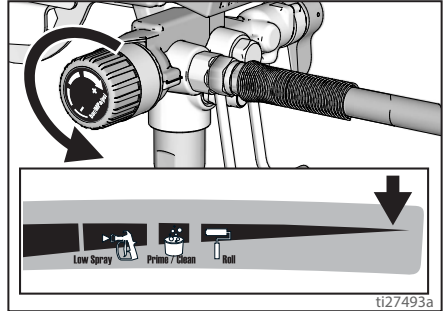

4. Put drain tube into a waste pail and turn Prime/Spray valve in **PRIME** position (drain) to relieve pressure.

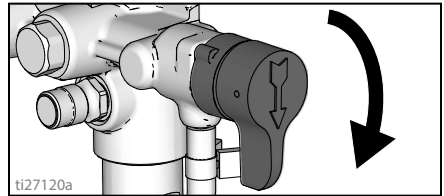

5. Hold the gun firmly to a pail. Point gun into pail. Disengage the trigger lock and trigger the gun to relieve pressure.

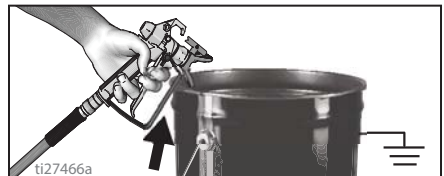

6. Engage the trigger lock.

Start Up

- If you suspect the spray tip or hose is clogged or that pressure has not been fully relieved:
 - VERY SLOWLY** loosen the tip guard retaining nut or the hose end coupling to relieve pressure gradually.
 - Loosen the nut or coupling completely.
 - Clear airless hose or spray tip obstruction. See **Clear Tip Clog**, page 18.

Flush Storage Fluid

This sprayer arrives from the factory with a small amount of test material in the system. **It is important that you flush this material from the sprayer before using it for the first time.** See **Cleaning Fluid Compatibility**, page 26 and **Static Grounding Instructions (Oil-Based materials)**, page 26 for additional information when using oil-based materials.

- Perform **Pressure Relief Procedure**, page 13.
- Make certain ON/OFF switch is **OFF**.
- Separate drain tube (smaller) from suction tube (larger).
- Place drain tube in a waste pail.
- Submerge suction tube in a pail partially filled with water or flushing fluid. If spraying oil-based materials, submerge the suction tube in mineral spirits, or compatible cleaning solvent. If spraying water-based materials, submerge the suction tube in water.

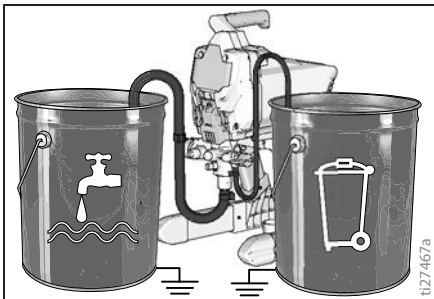

- Turn Prime/Spray valve down to **PRIME** position.

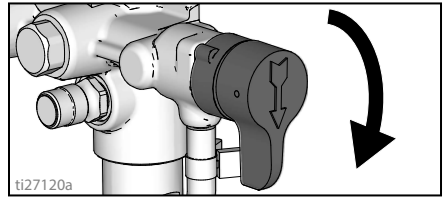

- Plug power supply cord into a properly grounded electrical outlet.
- Press PushPrime button twice to loosen inlet ball.

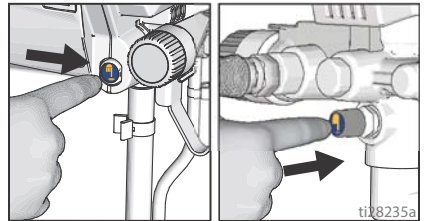

- Align setting indicator with Prime/Clean setting on pressure control knob.

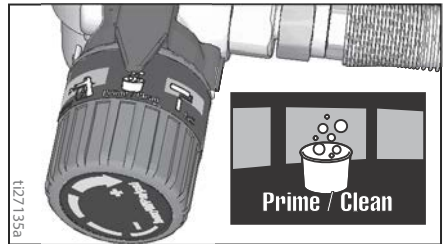

- Turn ON/OFF switch to **ON** position.

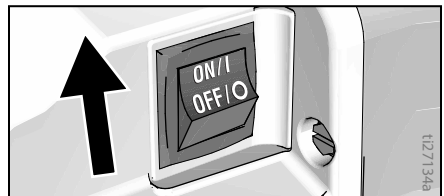

- When sprayer starts pumping, flushing solvent and air bubbles will be purged from system. Allow fluid to flow out of drain tube, into waste pail, for 30 to 60 seconds.
- Turn ON/OFF switch to **OFF** position.



- Inspect for leaks. If leaks occur, perform **Pressure Relief Procedure**, page 13, then tighten all fittings and repeat **Start Up**. If there are no leaks continue with the next step.

Fill Pump

- Move suction tube to paint pail and submerge suction tube in paint.

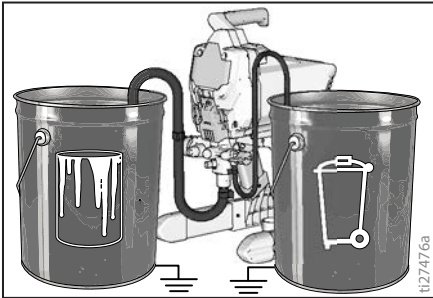

- Turn ON/OFF switch to **ON** position.
- Wait to see paint coming out of drain tube.
- Turn ON/OFF switch to **OFF** position.

NOTE: Some fluids may prime faster if the ON/OFF Switch is momentarily turned off so the pump can slow and stop. Turn ON/OFF switch on and off several times if necessary.

Fill Gun and Hose

- Hold gun against waste pail. Point gun into waste pail.
 - Disengage trigger lock.
 - Pull and hold gun trigger.
 - Turn Prime/Spray valve horizontal to **SPRAY** position.
 - Turn ON/OFF switch to **ON** position.

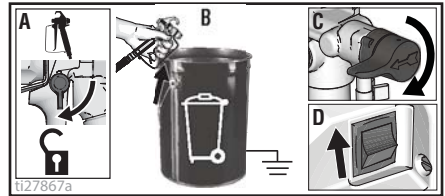

- Trigger gun into waste pail until only paint comes out of the gun.
- Release trigger. Engage trigger lock.
- Transfer drain tube to paint pail and clip to suction tube.

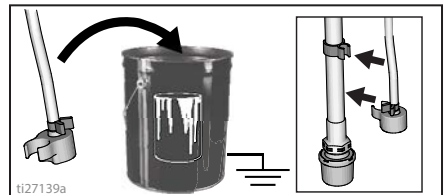

NOTE: When motor stops, sprayer is ready to paint. If motor continues to run, sprayer is not properly primed. Repeat **Fill Pump** and **Fill Gun and Hose**.

How to Spray

How to Spray

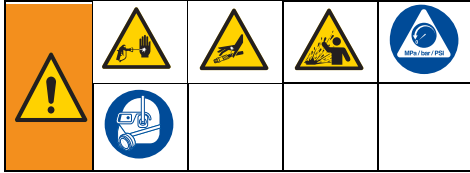

Spray Tip Installation

To prevent spray tip leaks make certain spray tip and tip guard are installed properly.

1. Perform **Pressure Relief Procedure**, page 13.
2. Engage trigger lock.
3. Verify spray tip and tip guard parts are assembled in the order shown.

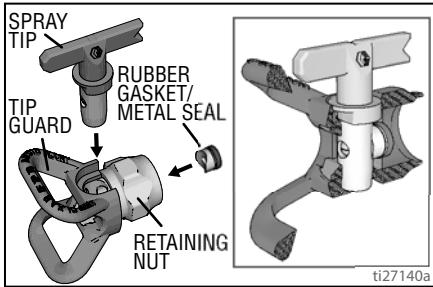

- a. Use spray tip to align gasket and seal in the tip guard.

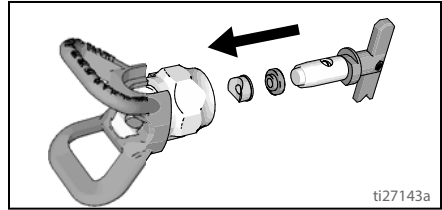

- b. Spray tip must be pushed all the way into the tip guard. Turn spray tip to push down.

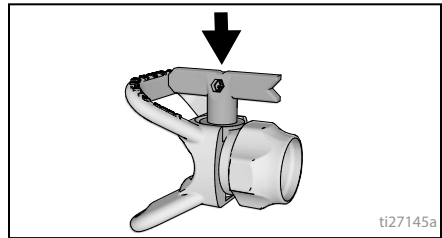

- c. Turn the arrow shaped handle on the spray tip forward to the spray position.
4. Screw spray tip and tip guard assembly onto the gun and tighten.

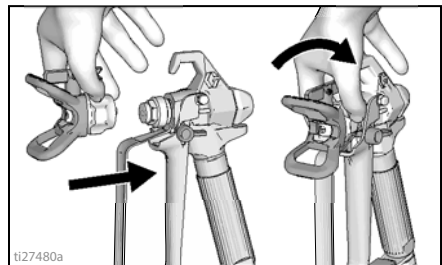

Adjust Pressure Control

The pressure control knob allows for infinite pressure adjustment. To reduce overspray, always start at the lowest pressure setting and increase pressure to the minimum setting that results in an acceptable spray pattern.

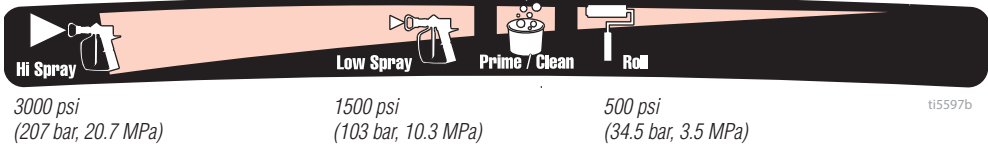

To select function, align symbol on pressure control knob with setting indicator on sprayer.

Tip and Pressure Selection

See table for recommended spray pressure for your material. Refer to paint (material) can for manufacturer's recommendations.

Maximum tip hole sizes supported by the sprayer:

- X5: 0.015 in. (0.38 mm) - X7: 0.017 in. (0.43 mm)
- ProX17: 0.017 in. (0.43 mm) - ProX19: 0.019 in. (0.48 mm) - ProX21: 0.021 in. (0.53 mm)

	Coatings				
	Interior Stains/ Interior & Exterior Clears	Exterior Solid Stains	Primers	Interior Latex Paints	Exterior Latex Paints
Spray Pressure	Low Spray	High Spray	High spray	High Spray	High Spray
Tip hole Size					
0.011 in. (0.28 mm)	✓				
0.013 in. (0.33 mm)	✓	✓	✓	✓	
0.015 in. (0.38 mm)		✓	✓	✓	✓
0.017 in. (0.43 mm)			✓	✓	✓
0.019 in. (0.48 mm)					✓
0.021 in. (0.53 mm)					✓

Spray Techniques

Use a piece of scrap cardboard to practice these basic spraying techniques before you begin spraying the surface.

- Hold gun 12 in. (30 cm) from surface and aim straight at surface. Tilting gun to direct spray angle causes an uneven finish.
- Flex wrist to keep gun pointed straight. Fanning gun to direct spray at angle causes uneven finish.

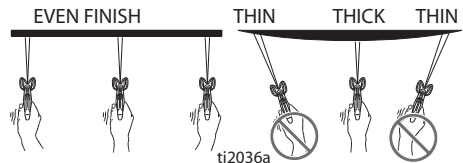
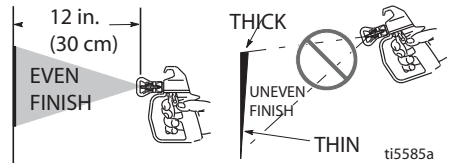

How to Spray

Triggering Gun

Pull trigger after starting stroke. Release trigger before end of stroke. Gun must be moving when trigger is pulled and released.

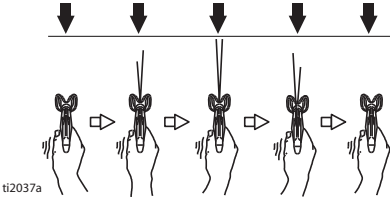

Aiming Gun

Aim center of spray of gun at bottom edge of previous stroke, overlapping each stroke by half.

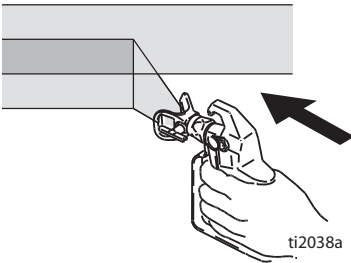

Spray Pattern Quality

A good spray pattern is evenly distributed as it hits the surface.

- Spray should be atomized (evenly distributed, no gaps at edges).

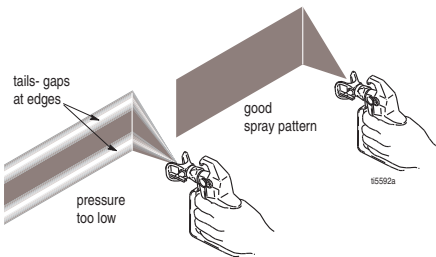

If tails persist when spraying at the highest spray pressure:

- Spray tip may be worn. See **Tip and Pressure Selection**, page 17.
- A smaller spray tip may be needed.

- Material may need to be thinned. If material needs to be thinned follow manufacturer's recommendations.

Clear Tip Clog

In the event that particles or debris clog the spray tip, this sprayer is designed with a reversible spray tip that quickly and easily clears the particles without disassembling the sprayer.

See **Strain the Paint**, page 12 for additional information.

1. Engage trigger lock. Rotate spray tip to unclog position. Disengage trigger lock. Trigger gun at waste area to clear clog.

UNCLOG

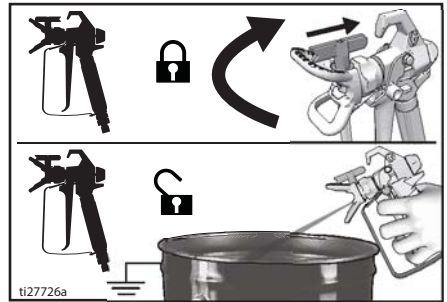

NOTE: If spray tip is difficult to rotate when turning to the unclog position perform, **Pressure Relief Procedure**, page 13, then turn Prime/Spray valve to spray position and repeat step 1.

2. Engage trigger lock. Rotate spray tip back to spray position. Disengage trigger lock and continue spraying.

SPRAY

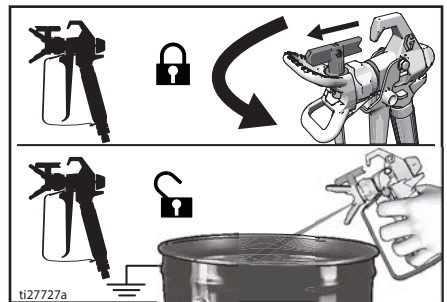

Cleanup

Cleaning the sprayer after each use results in a trouble free start up the next time the sprayer is used.

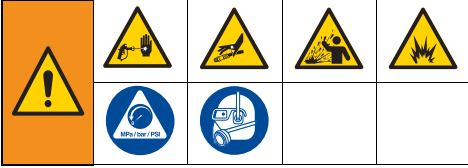

Cleaning from a Pail

- For short term shutdown periods (overnight to two days) refer to **Short Term Storage**, page 23.
 - See **Cleaning Fluid Compatibility**, page 26 for information on flushing/cleaning fluids and **Static Grounding Instructions (Oil-Based materials)**, page 26.
1. Perform **Pressure Relief Procedure**, page 13.
 2. Remove spray tip and tip guard assembly from gun and place in waste pail.

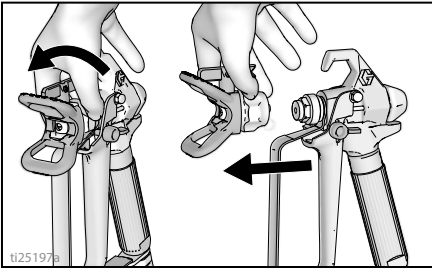

3. Lift suction tube and drain tube from paint pail. Let paint drain into the pail.
4. Separate drain tube (smaller) from suction tube (larger).

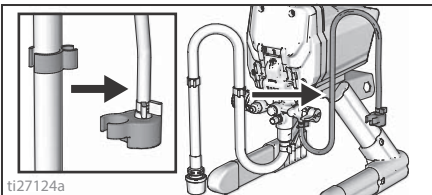

5. Place empty waste and flushing fluid pails side by side.
6. Place suction tube in flushing fluid. Use water for water based paint and mineral spirits or compatible oil-based flushing solvent for oil-based paint. Place drain tube in waste pail.

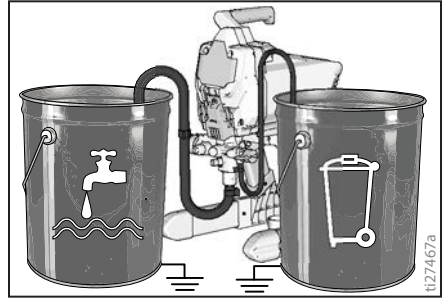

7. Turn pressure control knob to the Prime/Clean setting.

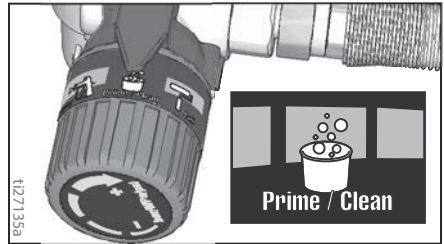

8. Turn Prime/Spray valve down to PRIME position.

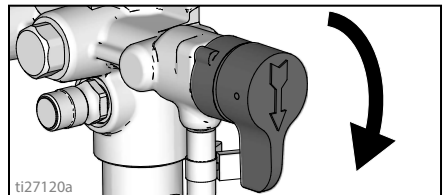

9. Turn ON/OFF switch to **ON** position.
10. Flush until approximately 1/3 of the flushing fluid is emptied from the pail.

Cleanup

- Turn ON/OFF switch to **OFF** position.

NOTE: Step 12 is for returning paint in hose to paint pail. One 50 ft (15 m) hose holds approximately 1 quart (1 liter) of paint.

- To recover paint in hose, point gun into paint pail while holding gun firmly to the pail.
 - Disengage trigger lock.
 - Pull and hold gun trigger.
 - Turn Prime/Spray valve horizontal to **SPRAY** position.
 - Turn ON/OFF switch to **ON** position.
 - Continue to hold gun trigger until you see paint diluted with flushing fluid starting to come out of gun.

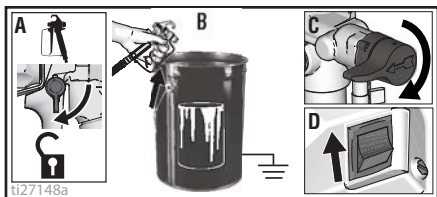

- While continuing to trigger gun, quickly move gun to redirect spray into waste pail. Continue triggering gun into waste pail until flushing fluid dispensed from gun is relatively clear.

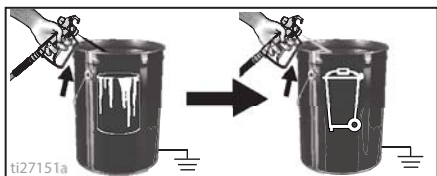

- Turn pressure control knob to the lowest setting.
- Stop triggering gun. Engage the trigger lock.

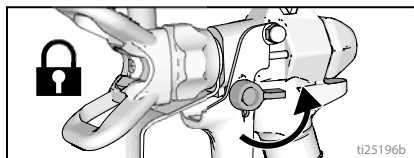

- Turn Prime/Spray valve down to **PRIME** position.
- Turn ON/OFF switch to **OFF** position.
- Clean outlet filter. ProX only: See **Cleaning InstaClean™ Fluid Filter (ProX only)**, page 22.
- Fill unit with Pump Armor™ fluid. See **Long Term Storage**, page 23.

Cleanup with Power Flush Adapter

(Water-based materials only)

Power flushing is a faster method of cleanup. It can only be used after spraying water-based coatings.

- Perform **Pressure Relief Procedure**, page 13.
- Remove spray tip and tip guard assembly from gun and place in waste pail.

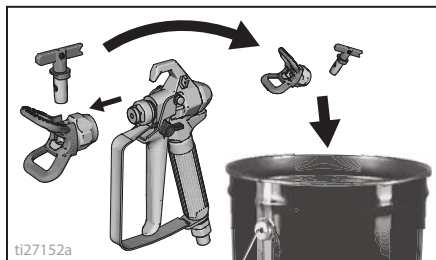

- Place empty waste and paint pails side by side.
- Lift suction tube and drain tube from paint pail. Let paint drain into the pail.
- Place suction and drain tube in waste pail.

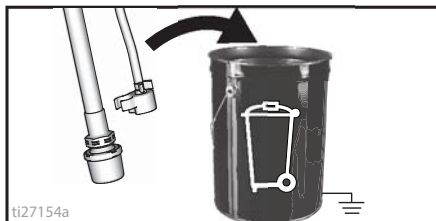

- Turn pressure control knob to the Prime/Clean setting.

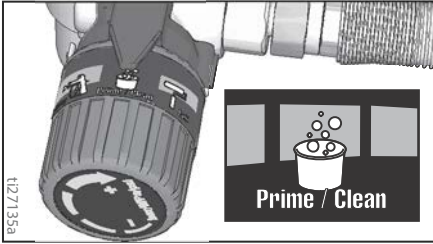

- Screw Power Flush attachment valve to garden hose. Close valve.

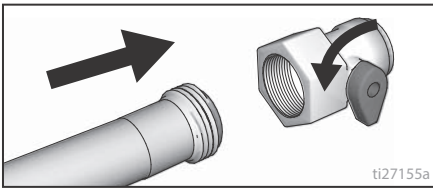

- Turn on water. Open valve. Rinse paint off suction tube, drain tube and inlet strainer. Close valve.

- Unscrew inlet strainer from suction tube. Place inlet strainer in waste pail.

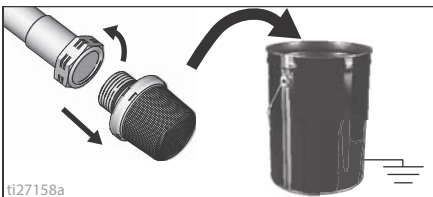

- Connect garden hose to suction tube with Power Flush attachment valve. Leave drain tube in waste pail.

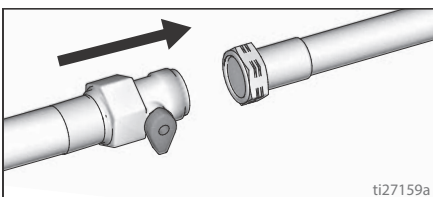

- Turn ON/OFF switch to **ON** position.
- Open Power Flush attachment valve.
- Circulate water through sprayer, into waste pail, for 20 seconds.
- Turn ON/OFF switch to **OFF** position.

NOTE: Step 15 is for returning paint in hose to paint pail. One 50 ft (15 m) hose holds approximately 1 quart (1 liter) of paint.

- To recover paint in hose, point gun into paint pail while holding gun firmly to the pail.
 - Disengage trigger lock.
 - Pull and hold gun trigger.
 - Turn Prime/Spray valve horizontal to **SPRAY** position.
 - Turn ON/OFF switch to **ON** position.
 - Continue to hold gun trigger until you see paint diluted with flushing fluid starting to come out of gun.

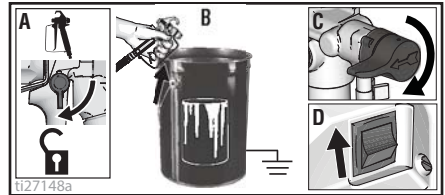

- While continuing to trigger gun, quickly move gun to redirect spray into waste pail. Continue triggering gun into waste pail until flushing fluid dispensed from gun is relatively clear.

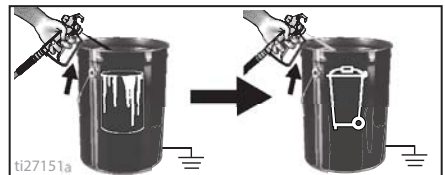

- Turn pressure control knob to the low-est setting.
- Stop triggering gun. Engage the trigger lock.

Cleanup

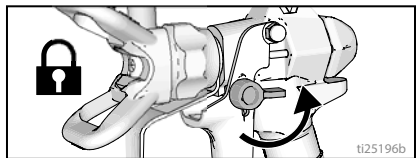

19. Turn Prime/Spray valve down to PRIME position.

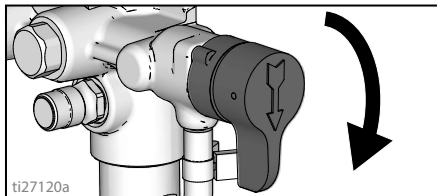

20. Turn ON/OFF switch to OFF position.

Cleaning InstaClean™ Fluid Filter (ProX only)

The InstaClean Fluid Filter prevents particles from entering paint hose. After each use, remove and clean it to ensure peak performance.

1. Perform **Pressure Relief Procedure**, page 13.
2. Disconnect airless spray hose (A) from sprayer.
3. Unscrew outlet fitting (B).
4. Remove InstaClean Fluid Filter (C).

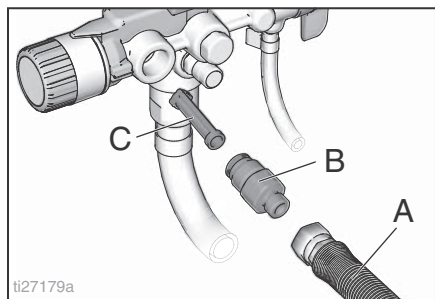

5. Check InstaClean Fluid Filter (C) for debris. If needed, clean filter with water or flushing fluid and a soft brush.

- a. Install closed (square) end of InstaClean Fluid Filter (C) in sprayer.
 - b. Screw outlet fitting (B) into sprayer.
6. Tighten outlet fitting and reconnect hose (A) to sprayer. Use two wrench to tighten securely.

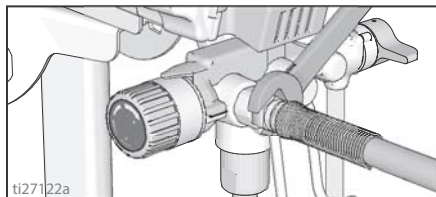

Clean the Gun

1. Clean gun fluid filter with water or flushing fluid and a brush every time you flush the system. Replace gun filter if damaged.

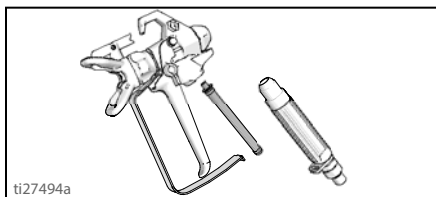

2. Remove spray tip and tip guard and clean with water or flushing fluid and a brush.

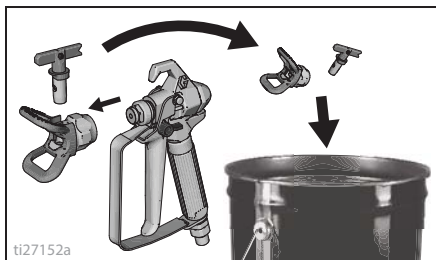

3. Wipe paint off outside of gun using a soft cloth moistened with water or flushing fluid.

Storage

With proper storage, the sprayer will be ready to use the next time it is needed.

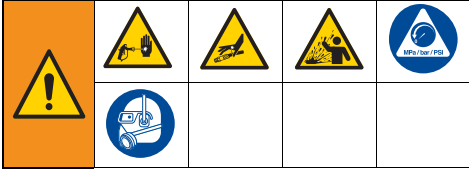

Short Term Storage

(up to 2 days)

1. Perform **Pressure Relief Procedure**, page 13.
2. Leave suction tube and drain tube in paint pail.

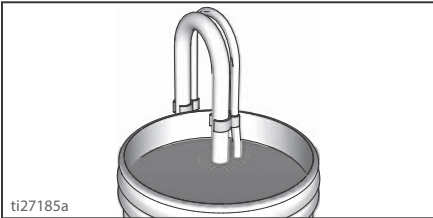

3. Cover paint and pail tightly with plastic wrap.

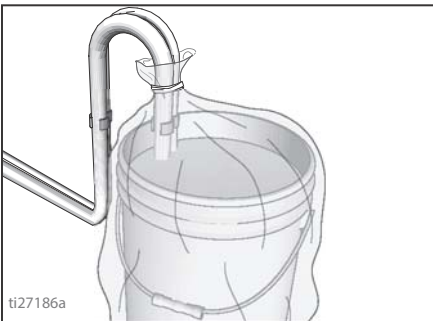

4. Engage trigger lock.

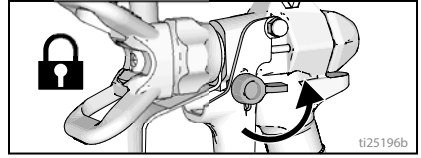

5. Leave gun attached to hose.
6. Remove tip and guard and clean with water or flushing fluid and a brush.
7. Wipe paint off outside of gun using a soft cloth moistened with water or flushing fluid.

Long Term Storage

(more than 2 days)

Pump Armor fluid protects the sprayer against freezing and corrosion.

- Before storing sprayer make sure all water is drained out of sprayer.
 - Do not allow water to freeze in sprayer.
 - Do not store sprayer under pressure.
 - Store sprayer indoors.
1. Perform **Pressure Relief Procedure**, page 13.
 2. Place suction tube in Pump Armor fluid bottle and drain tube in waste pail.

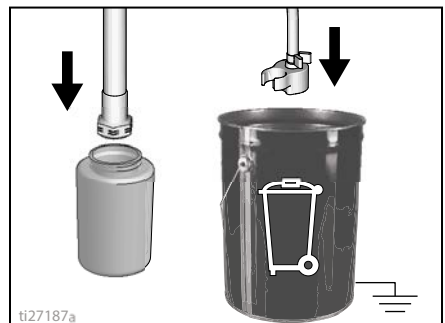

Storage

3. Turn Prime/Spray valve down to PRIME position.

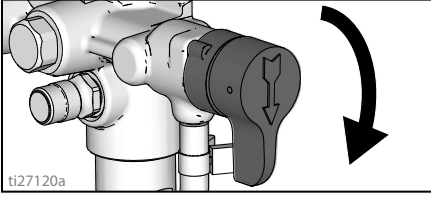

4. Turn ON/OFF switch to **ON** position.
5. Turn pressure control knob clockwise until the pump turns on.
6. When storage fluid comes out of drain tube (5-10 seconds) turn ON/OFF switch to **OFF** position.
7. Turn Prime/Spray valve horizontal to SPRAY position to keep storage fluid in sprayer during storage.

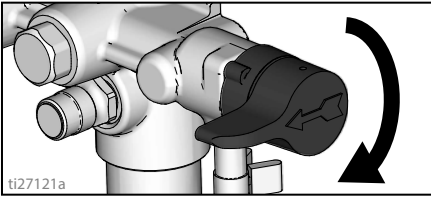

8. Leave gun attached to hose.
9. Remove tip and guard and clean with water or flushing fluid and a brush.
10. Wipe paint off outside of gun using a soft cloth moistened with water or flushing fluid.

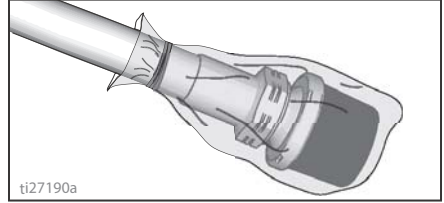

11. Secure a plastic bag around suction and drain tube to catch any drips.