

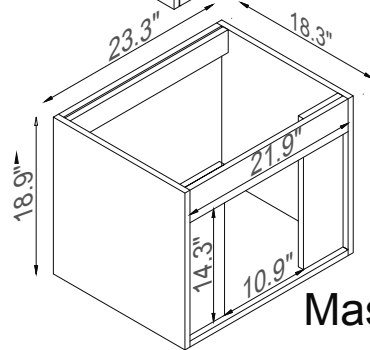

Streamline

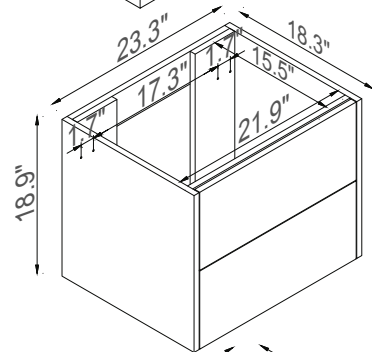
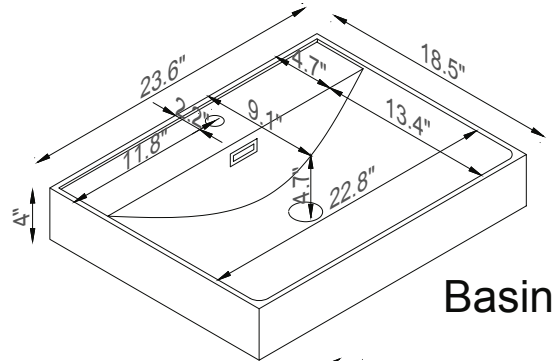
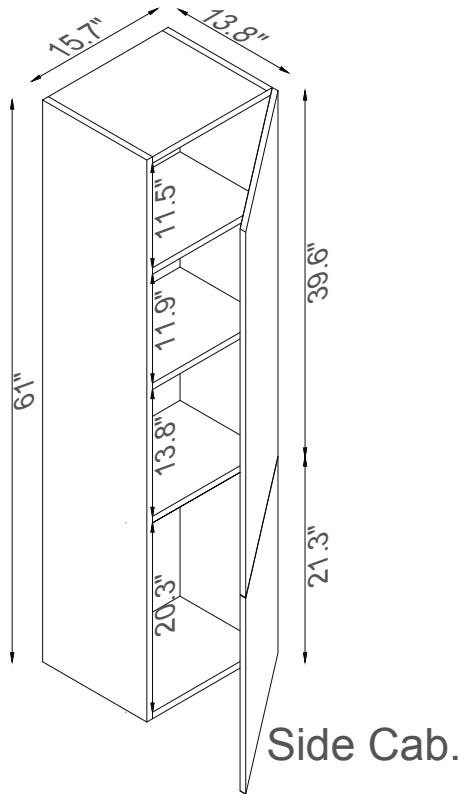

K1500-170-24-511S