

ALPHA

— B I D E T —

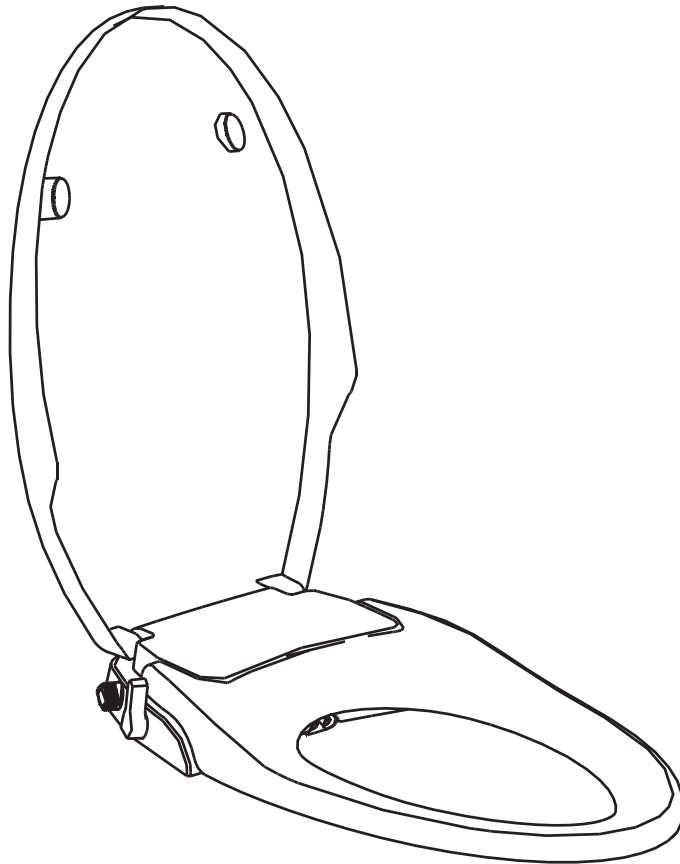

MODEL NUMBER

ALPHA ONE
elongated

NOTES

- ▶ This product was manufactured for household use only.
- ▶ Read all operating instructions before installation and use.
- ▶ Please save this operating instruction manual and place in an easily accessible location.
- ▶ Due to ongoing product improvements, external appearance and specifications are subject to change without notice.

CONTENTS

Components	01
Parts List	02
Pre-Installation	03
Installation Procedure	04
Installation Procedure (cont)	05
Operation	06
Cleaning and Maintenance	07
Self Diagnosis and Specs	08
Warranty	09
Warranty (cont)	10

ALPHA ONE

1 Components

■ Product

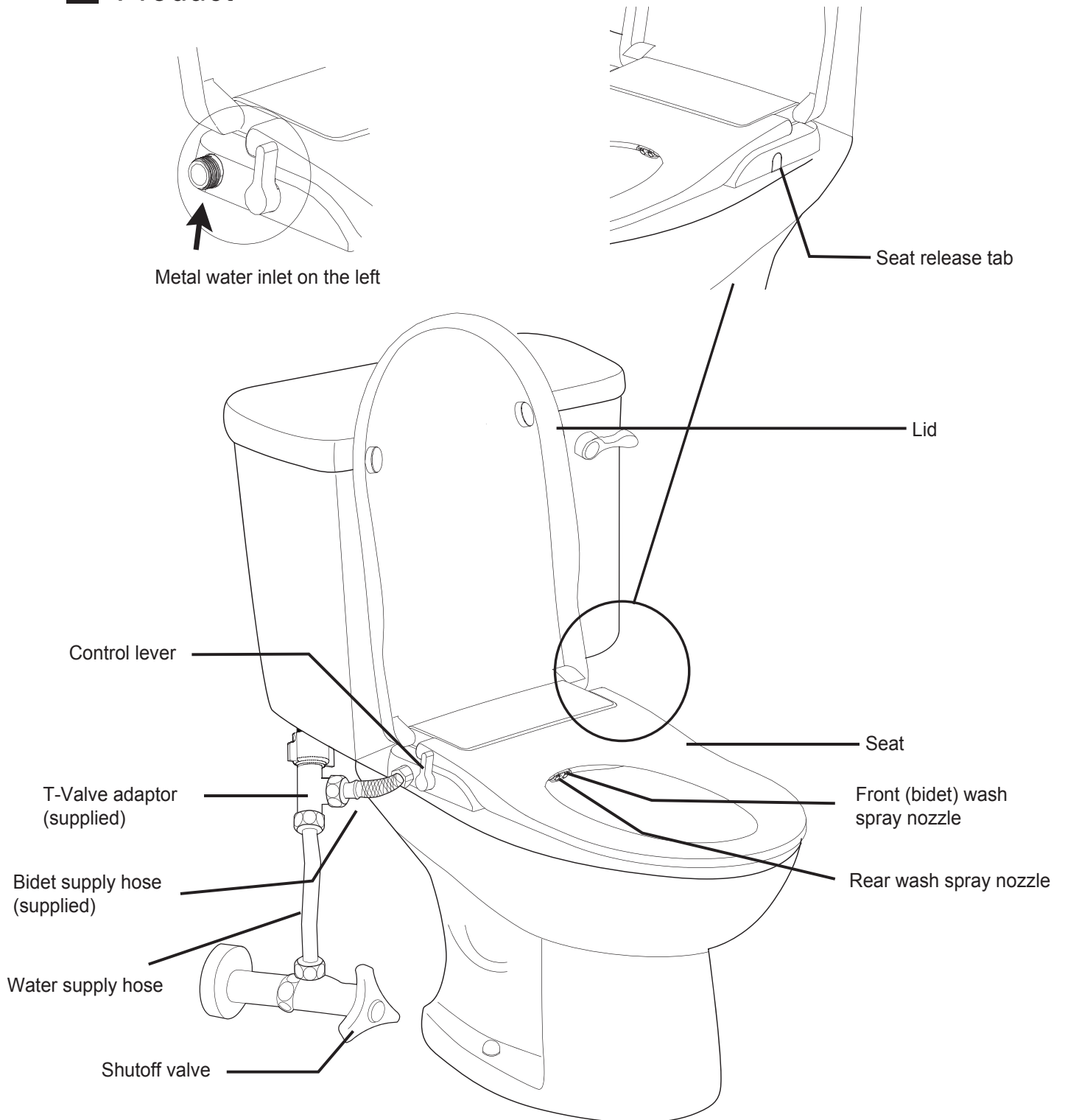

ALPHA ONE

Parts List

1. Main body

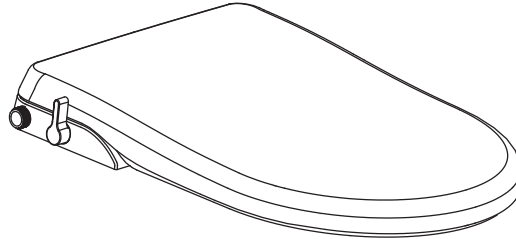

2. Installation components

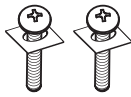

Metal mounting bolts (2)



Rubber expansion nuts (2)

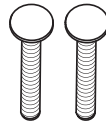

Plastic mounting bolts (2)



Butterfly Nut (2)

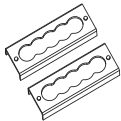

Mounting brackets (2)

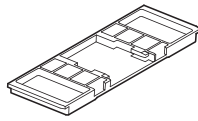

Catch plate

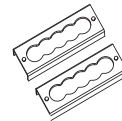

Mounting brackets (2)

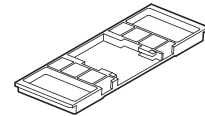

Catch plate

Note:

There are two methods for installation. The recommended way is using the rubber expansive nuts. The second option is using the butterfly nuts. Please select the option best suited for your specific installation needs.

3. T-Valve adaptor

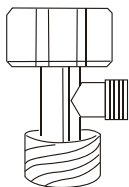

4. Water supply hose

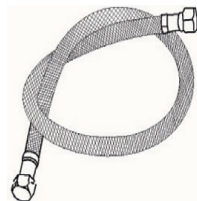

5. User manual

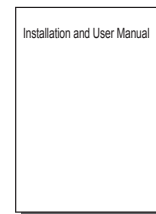

2 Installation

Please make sure you read the instructions carefully and install it properly.

■ Caution

1. The water pressure limit is from 10 to 110 PSI. Please use as instructed.
2. The water shutoff valve should be near where the product is installed.

■ Product Installation Procedure

■ Pre-installation

1. Insert the mounting bolts into the rectangular steel mounting brackets.

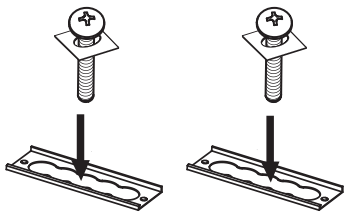

2. Insert the mounting bolts with the brackets into the catch plate.

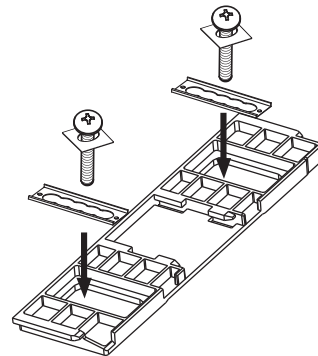

3. Example of how the bolts fit through the mounting brackets and how they are placed onto the catch plate and secured to the toilet.



ALPHA ONE

■ Installation Procedure

● First installation method (recommended)

1. Completely remove the old toilet seat & lid



2. Install expansion nuts. Be sure to firmly press down so the top of the expansion nut is flush with the ceramic toilet surface.

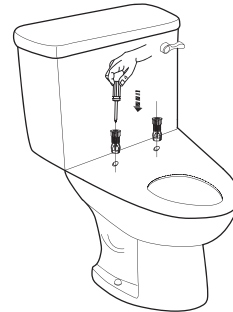

3. Attach the catch plate

- Attach the catch plate in the toilet seat holes. Adjust the position of mounting bolts and adjusting pieces to line up the mounting bolts to the expansion nuts. Then tighten to secure the catch plate.



4. Install the bidet seat

- Line up the bidet with the catch plate then push the bidet seat onto the catch plate. You will hear the bidet seat click into the place.

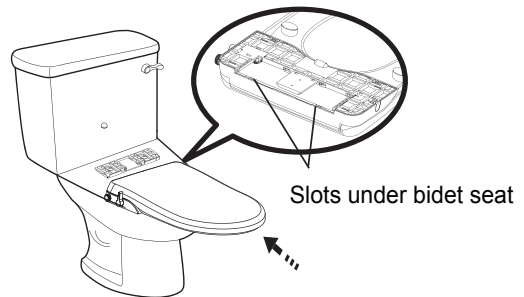

● Second installation method

1. Remove the old toilet seat. Put the installation catch plate on the ceramic toilet bowl. Refer to first installation method step 1.

2. Put the catch plate over the toilet seat mounting holes in the ceramic of the connecting bolts with adjusting pieces. Screw on the nuts from underneath the toilet. Then tighten to secure the catch plate. Refer to the first installation step 3.

ALPHA ONE

■ Connecting Water Supply

1. Close the water supply valve. Flush toilet.

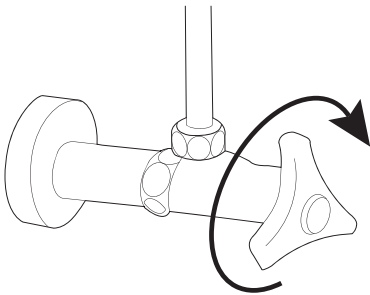

2. Unscrew water supply hose from water tank. Place towel below tank to catch any dripping water.

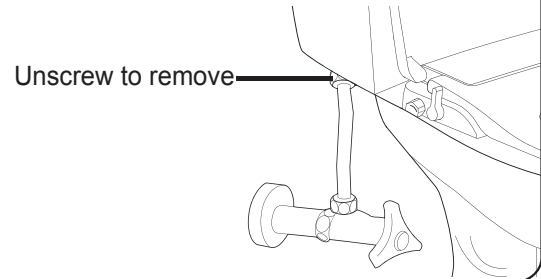

3. Using finger nut, attach T-Valve to water tank where you removed the water supply hose.

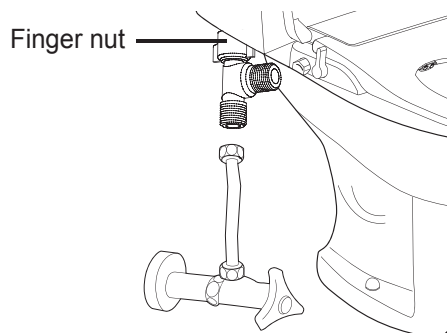

4. Re-attach water supply hose to bottom of T-Valve.

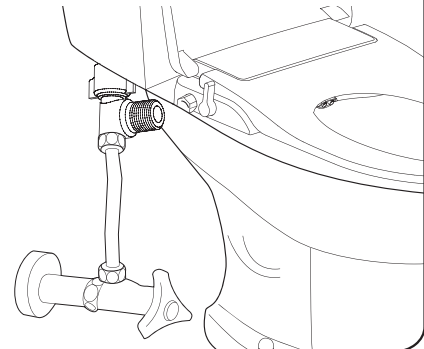

5. Connect the bidet supply hose to the metal inlet on the side of the bidet seat. Connect the other end of the hose to the T-Valve and tighten snugly. Be careful not to over-tighten.

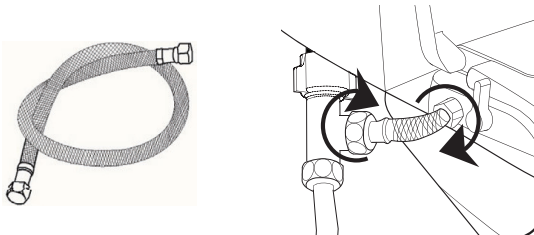

6. Slowly open the water valve to check if there is any water leakage.

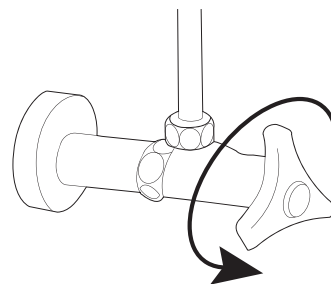

7. Wipe the hoses and connectors thoroughly with a towel and carefully observe for any leaks for at least 10 minutes. Tighten any connectors gently until leakage stops. If any leaks continue, turn off water supply and check hoses for damaged rubber o-rings. Teflon tape may be used on connections to help seal.

3 Operation

■ STOP

- Return the lever to the upright position to turn it off.

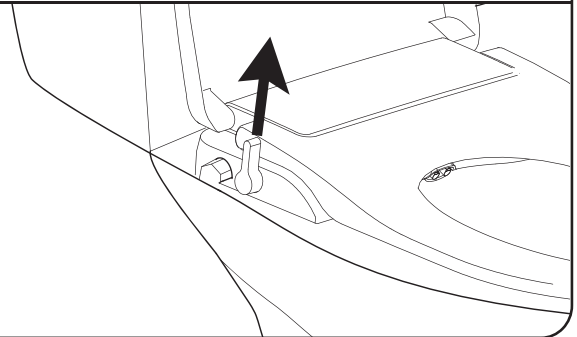

BIDET (FRONT FEMININE WASH)

- Gradually push control lever forward until preferred pressure is reached.

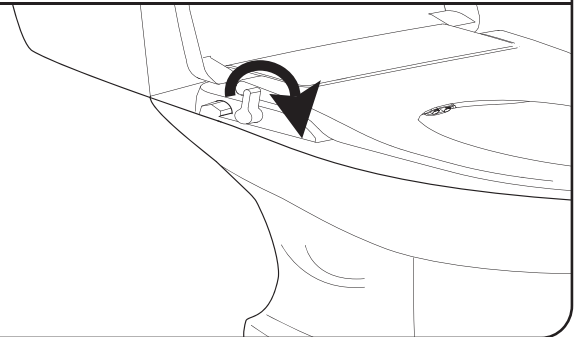

REAR WASH

- Gradually push control lever back until preferred pressure is reached.

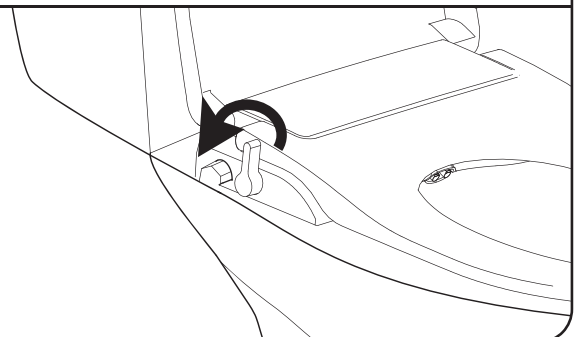

4 Cleaning and Maintenance

1. Cleaning the exterior of the bidet seat

Use a smooth sponge/cloth with water and/or mild soap to clean the product. Do not use the following types of cleaning products: hydrogen chloride detergent, paint thinner, benzene abrasive paper, polishing agent, bleach, or chlorine.

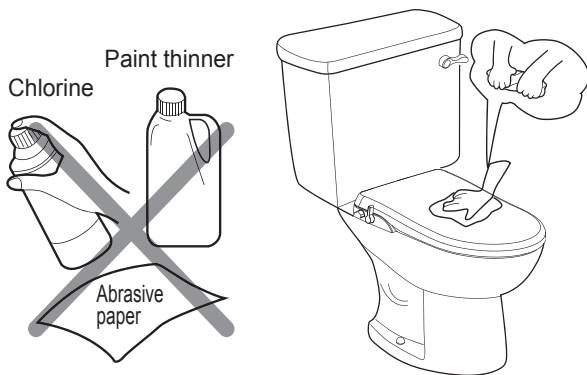

2. Cleaning the spray nozzles

Pull out the nozzle softly and use a smooth cloth/sponge or soft toothbrush to clean the nozzle

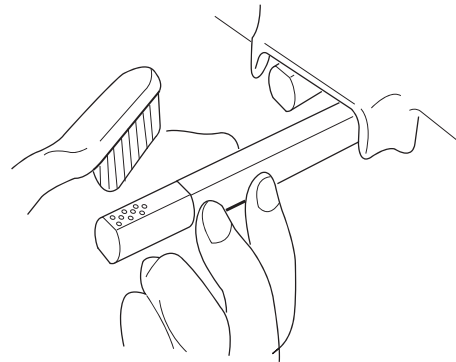

3. Clean the filter and regulator

(If the water flow is less than usual)

1. Turn off water supply, remove the bidet supply hose and clean the filter screen.
2. Clean the regulator o-ring

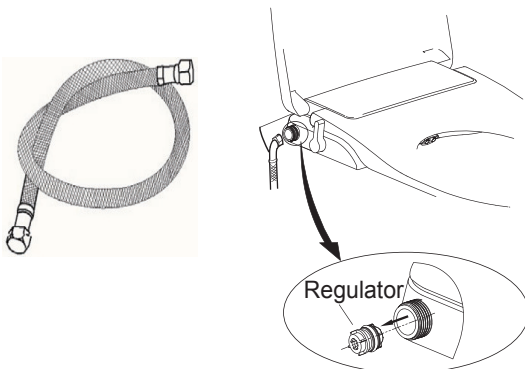

4. Remove the main body

Close the cover. Push and hold the release button and pull the bidet seat forward as shown.

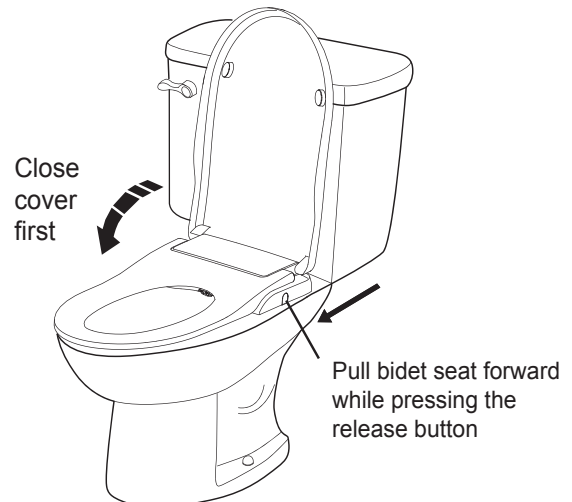

6 Self Diagnosis and Specifications

Self Diagnosis and Troubleshooting

Status	Cause	Solution
Water is too low during WASH/BIDET	1. Low water pressure of the unit	During use, turn the lever forward or backward to highest setting
	2. Low water pressure of water supply	If the water supply pressure is too low, contact your local water utility.
No water comes out during WASH/BIDET	1. Water shut-off valve is turned off	Turn on the water shut-off valve
	2. Filter of T-Valve Adaptor is clogged	Clean the filter of T-Valve Adaptor
	3. Filter of water inlet hose is clogged	Clean the filter of water inlet hose
	4. Nozzle head is stuck	Take off and clean the nozzle head
	5. External water pressure is low	Increase external water pressure
Water dropping from bowl when using the unit	External water pressure is too high	The maximum water pressure of the unit is 110 PSI. If the water supply pressure is above this, contact your local water utility.

If any issues still persist after troubleshooting, please contact us at support@alphabidet.com



Do not disassemble, repair, or remodel the unit as this will void warranty

Specifications

Classification	Description
Model No.	ONE
WASH water flow	0.35-1.8L/min
Feminine water flow	0.35-1.8L/min
Backflow Prevention	Check valve
Water Supply	Direct from water pipes
Water Pressure Range	10-110 PSI
Dimensions	19.68" (l) x 14.30" (w) x 2.25" (h)
Weight	4.85 lbs

Warranty

Your ALPHA ONE is warranted against defects in materials or workmanship for one (1) year from the date of original purchase. Defective parts or a defective product returned to ALPHA BIDET will be repaired with new or comparable rebuilt parts by ALPHA BIDET at their sole discretion.

This limited warranty given by ALPHA BIDET covers all defects encountered in normal use of the ALPHA ONE, and does not apply in the following cases:

1. Loss of or damage to the ALPHA ONE due to abuse, misuse, tampering, mishandling, improper packaging by you, alteration, and failure to follow operating instructions.
2. Use of parts or supplies (other than those by ALPHA BIDET's dealers) that cause damage to the ALPHA ONE.
3. Replacement of discolored or stained parts caused by chlorine, bleach, ammonia and other chemicals, cleaning supplies, oxidation, normal wear and tear.
4. Damage to or malfunction of the unit as a result of improper and negligent installation.

ALPHA ONE

5. Any and all damages to plumbing, walls, floors, ceiling and personal properties resulting from water leaks or breakage. The product must be used at the user's own risk. Therefore, the owner hereby releases the manufacturer and distributor from any and all claims for damages where the above condition exists.

No implied warranty, including any implied warranty of merchantability or fitness or a particular purpose, applies to ALPHA BIDET after the applicable period of the express limited warranty stated above, and no other express warranty or guarantee, except as mentioned above, given by any person or entity with respect to ALPHA BIDET shall bind ALPHA BIDET, (some states and provinces do not allow limitations on the length an implied warranty) so the above limitation may not apply to you. ALPHA BIDET shall not be liable for revenues or spacings, inconvenience, expense for substitute equipment or service, or any other special, incidental or consequential damages caused by the use or misuse of or inability to use, ALPHA BIDET, regard less of the possibility and foresee ability of such damages. In no event shall recovery of any kind against ALPHA BIDET be greater in amount than the purchase price of the product and causing the alleged damage. Without limiting the foregoing, you assume all risk and liability for loss, damage or injury to you and your property and to others and their property arising out of use or misuse of or inability to use the ALPHA BIDET not caused directly by the negligence of ALPHA BIDET. This limited warranty shall not extend to anyone other than the original purchaser of the ALPHA BIDET.

ALPHA BIDET

1773 W SAN BERNARDINO RD
STE B23
WEST COVINA, CA 91790

PHONE: 888.310.4511
EMAIL: support@alphabidet.com
WEB: <http://www.alphabidet.com>

