

NOTICE BEFORE ASSEMBLY

Please choose the CHAISE will be on the LEFT or RIGHT hand side

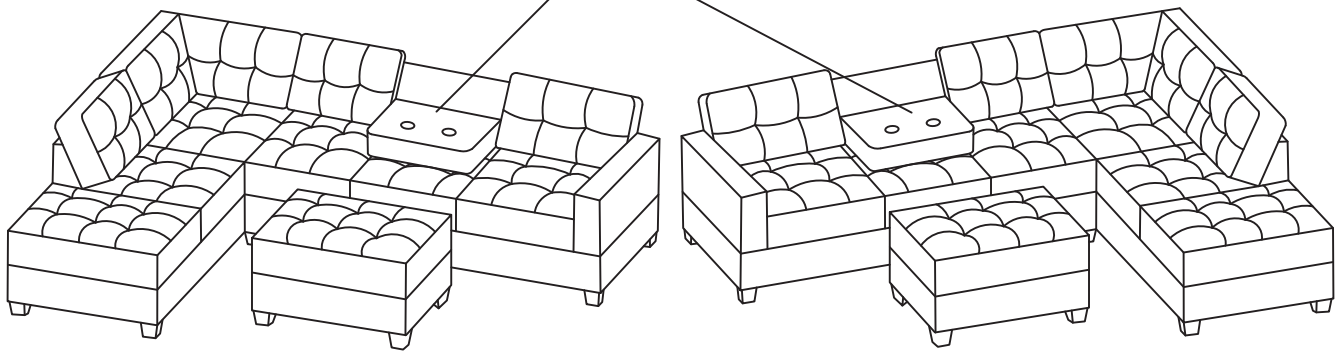





THE CONSOLE PIECE CAN BE TILTED DOWN AND TURN INTO AN ARM REST PANEL WITH CUP HOLDERS



CHAISE ON THE LEFT

CHAISE ON THE RIGHT

PARTS LIST

1	 X 12	2	 X 11 M8 x 22	3	 X 4 1/4" x 25	4	 X 11 5/16" x 12	5	 X 1
6	 X 11 5/16" x 70	7	 X 1						

BEFORE ASSEMBLY

Open up the velcro of Non-Woven Fabric cover on the bottom of the seat frame to remove seat cushions, back cushions and pillow

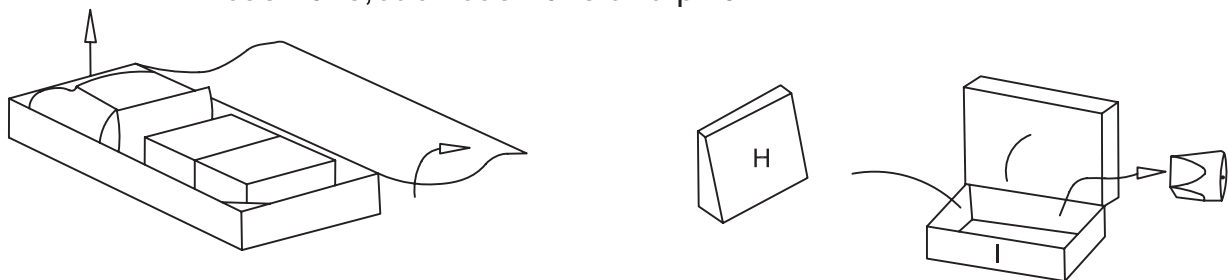

Remove hardware from inside the ottoman

Please remove all parts from seat frames and ottoman before assembly

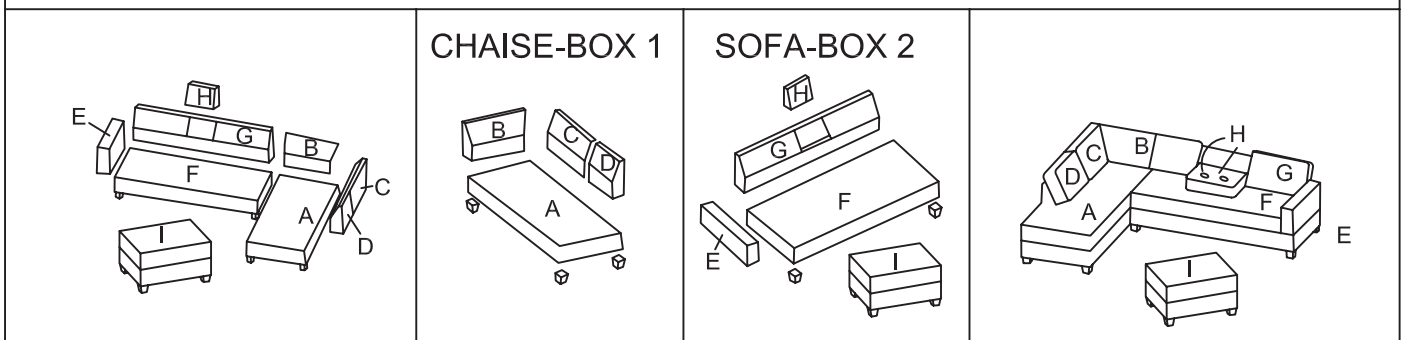

CHAISE ASSEMBLY INSTRUCTION - BOX1

STEP 1 - INSERT THREADED RODS INTO SEAT BACKS & ARM

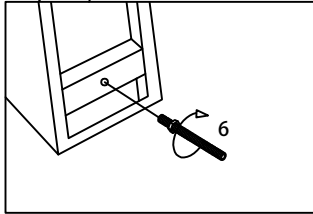
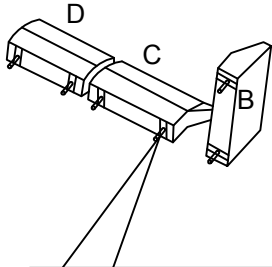

* Stop when the rod starts coming out on the other end

STEP 2 - MOUNT BACKS & ARM INTO THE SEAT FRAME

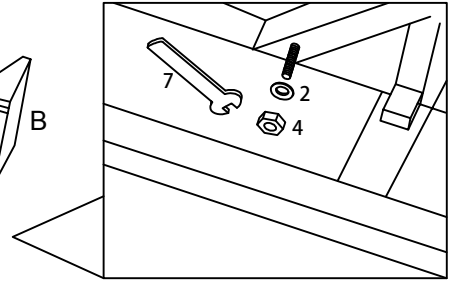
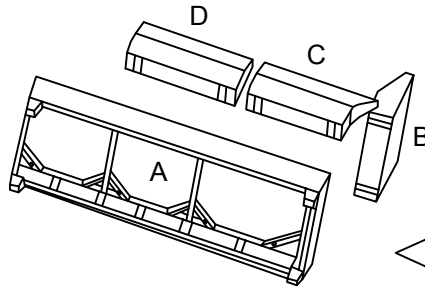

STEP 3 - PUT BACK THE FABRIC COVER AND INSERT LEGS

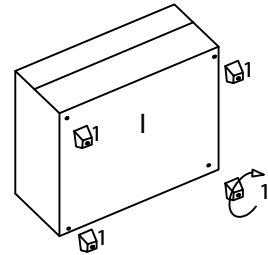
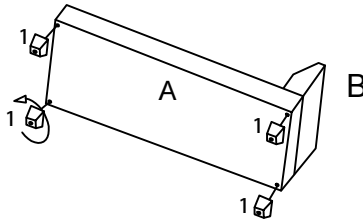

ONE - ARM SOFA ASSEMBLY INSTRUCTION - BOX 2

STEP 1 - INSERT THREADED RODS INTO SEAT BACKS & ARM

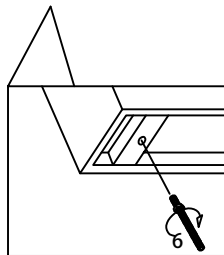
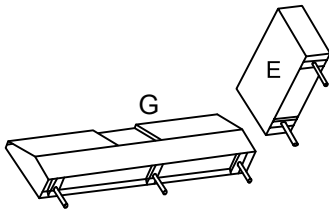

* Stop when the rod starts coming out on the other end

STEP 2 - MOUNT BACKS & ARM INTO THE SEAT FRAME

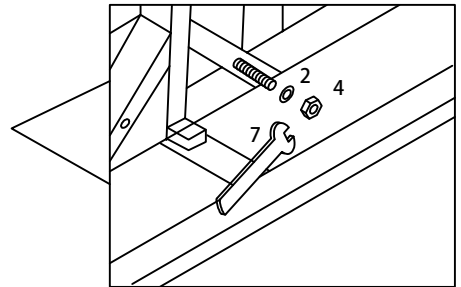
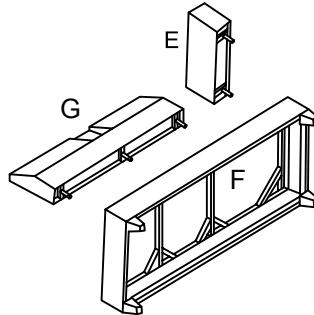

STEP 3 - PUT BACK THE FABRIC COVER AND INSERT LEGS

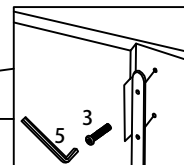
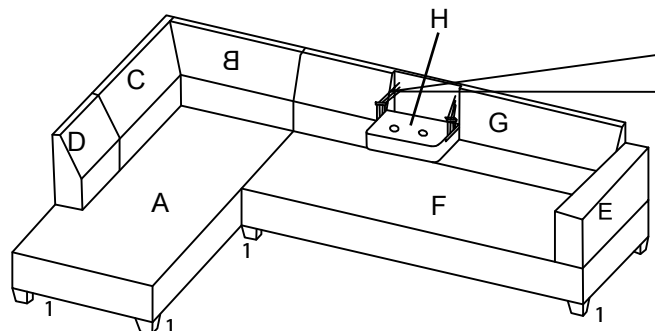
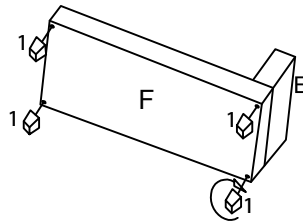

INSTALL THE CONSOLE PIECE BY INSERTING THREADED RODS INTO THE BACK GROOVE WITH HEXAGON WRENCH AT TWO SIDES.

CHAISE ASSEMBLY INSTRUCTION - BOX1

STEP 1 - INSERT THREADED RODS INTO SEAT BACKS & ARM

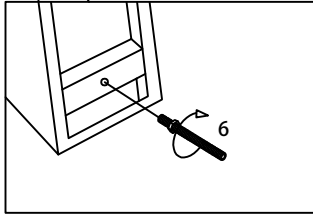
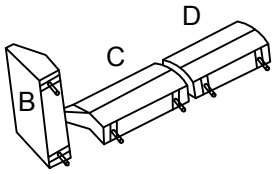

* Stop when the rod starts coming out on the other end

STEP 2 - MOUNT BACKS & ARM INTO THE SEAT FRAME

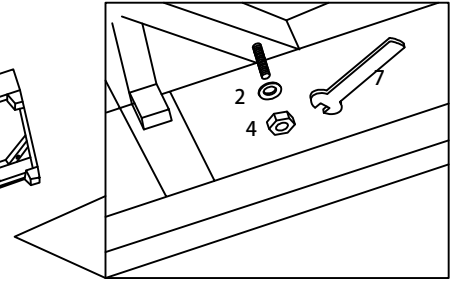
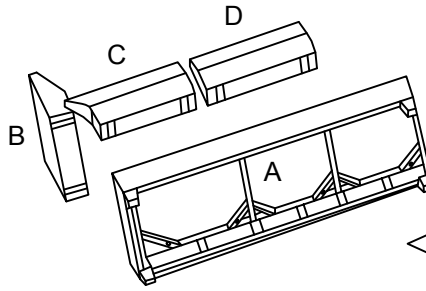

STEP 3 - PUT BACK THE FABRIC COVER AND INSERT LEGS

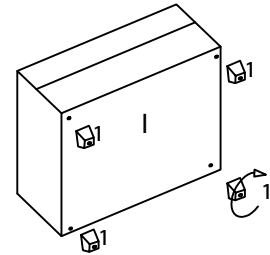
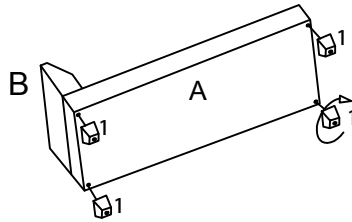

ONE - ARM SOFA ASSEMBLY INSTRUCTION - BOX 2

STEP 1 - INSERT THREADED RODS INTO SEAT BACKS & ARM

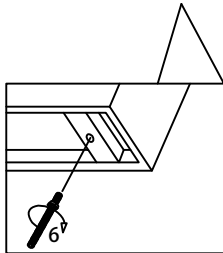
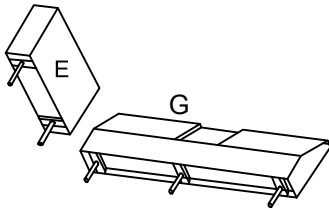

* Stop when the rod starts coming out on the other end

STEP 2 - MOUNT BACKS & ARM INTO THE SEAT FRAME

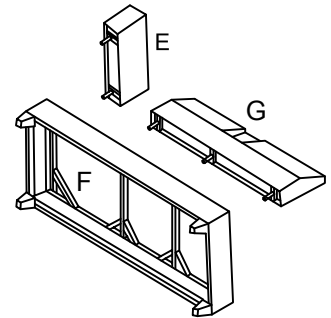
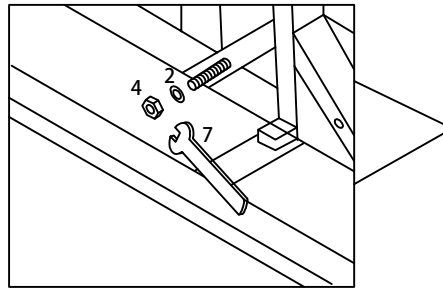

STEP 3 - PUT BACK THE FABRIC COVER AND INSERT LEGS

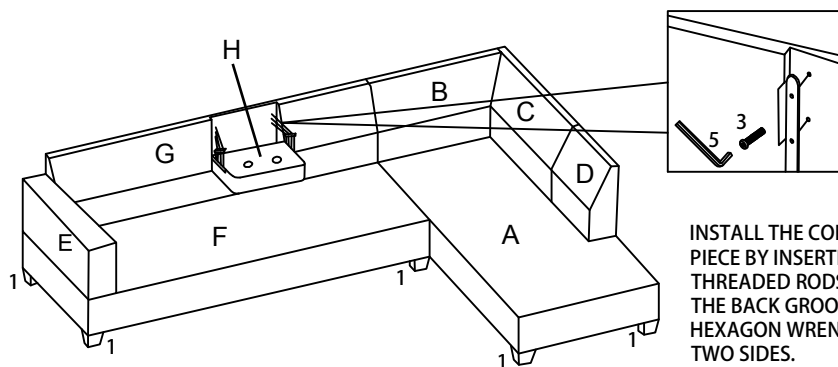
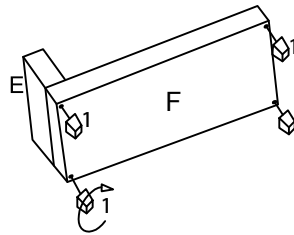

INSTALL THE CONSOLE PIECE BY INSERTING THREADED RODS INTO THE BACK GROOVE WITH HEXAGON WRENCH AT TWO SIDES.