



EVERLAST CLIMBING™

A PLAYCORE® Company



TOLL FREE 1-800-476-7366 | VOICE 651-665-9131 | FAX 651-665-9130 | INFO@EVERLASTCLIMBING.COM
WWW.EVERLASTCLIMBING.COM | 1335 MENDOTA HEIGHTS ROAD, MENDOTA HEIGHTS, MN 55120

PLEASE READ CAREFULLY BEFORE ASSEMBLING & USING PRODUCTS

- Please read instructions in their entirety prior to beginning installation.
- These assembly instructions are based on engineering that was designed to support the loading requirements per the Climbing Wall Association (CWA) Standard, 2009. This specification requires that bouldering walls be designed to support a climber load of 270 lbs or a uniform distribution load of 15 psf, whichever is greater.
- It is up to you to determine that the stud wall is of sound structural condition. Everlast Climbing assumes no responsibility for the structural condition of the stud wall.
- For a copy of the engineering for the attachment method of this product, please call 1.800.476.7366.
- 2x4 lumber purchased at a store usually exceed 8'. Be sure to trim them down if necessary.
- If necessary, use touch-up paint to paint the visible edges of the 2x4 lumber. Map out the sub wall prior to installation.

NOTE: These instructions show how to build a both an 8' H x 4' L and a 8' H x 12' L climbing wall (3 panels). Modifications need to be made for walls of differing length.

TOOLS REQUIRED

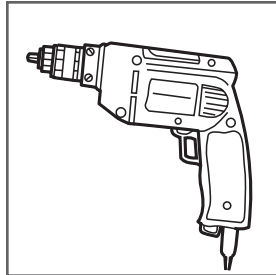

ELECTRIC DRILL

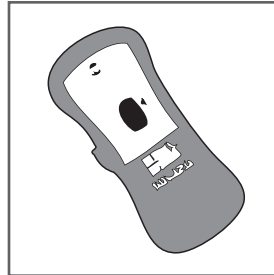

STUD FINDER



HAMMER

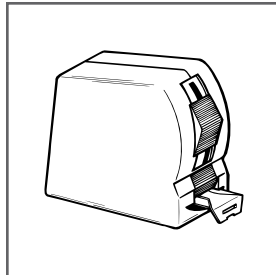

TAPE MEASURE

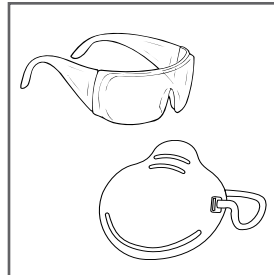

SAFETY GLASSES & DUST MASK

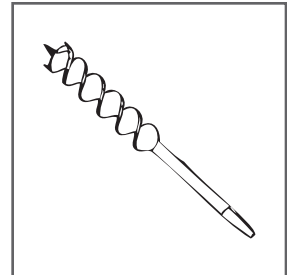

7/16" & 5/16" AUGER DRILL BIT

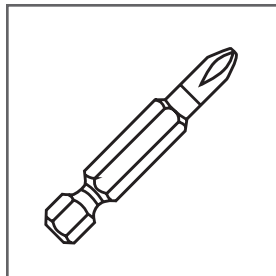

PHILLIPS BIT

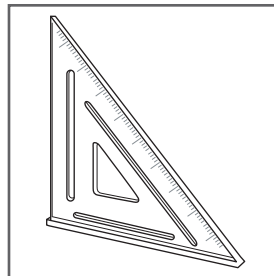

CARPENTER'S SQUARE

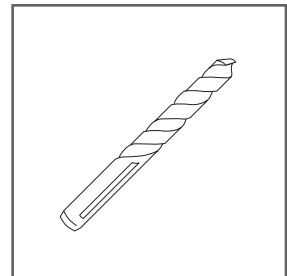

5/16" DRILL BIT

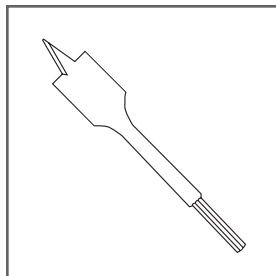

1-1/4" SPADE BIT

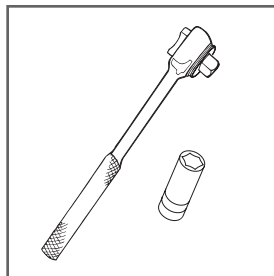

SOCKET WRENCH

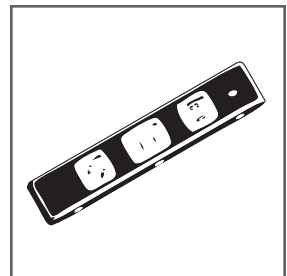

LEVEL

MATERIALS REQUIRED

96" H X 4" W X 2" D LUMBER

96" H X 6" W X 2" D LUMBER

SUPPLIED HARDWARE

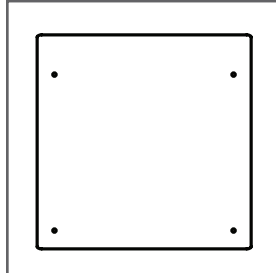

4' W X 4' H PANELS

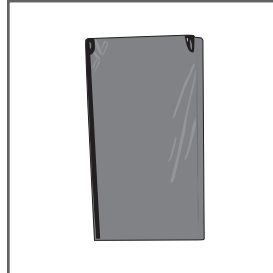

2' W X 6' H OR 4' W X 6' MATS

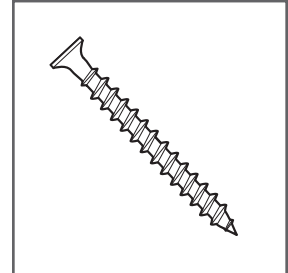

1-1/2" SCREWS

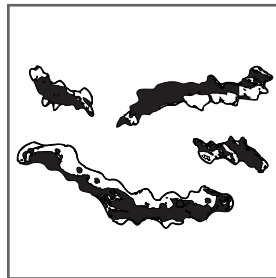

*RED-RELIEF LINE®

*NOT INCLUDED WITH SUPERIOR WALL KIT



HAND HOLDS

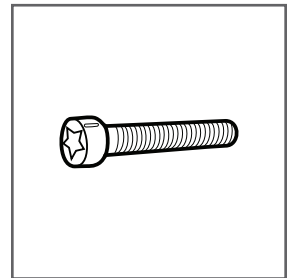

1-3/4" SOCKET HEAD CAP SCREWS

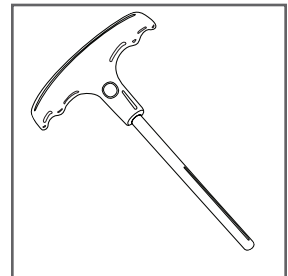

5/16" T-HANDLE ALLEN WRENCH

HARDWARE SUPPLIED WITH MAT KIT

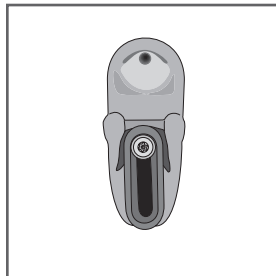

MAT LOCKING® HOLDS



STAR WRENCH

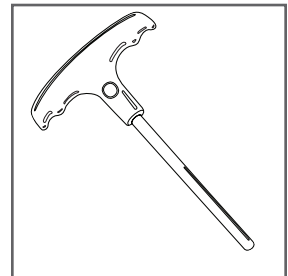

7/32" T-HANDLE ALLEN WRENCH

HARDWARE NOT SUPPLIED

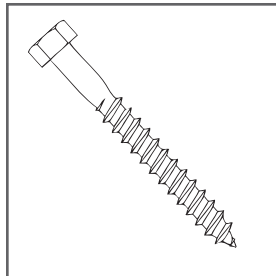

3/8" X 5" LAG SCREWS

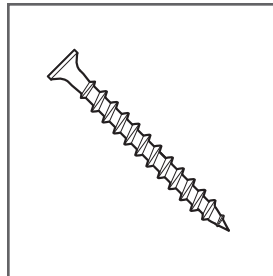

1-3/4" SCREWS

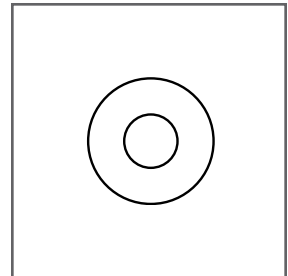

FLAT WASHERS

Installing Your Wall

A-1. SINGLE PANEL SUB WALL PREPARATION

1. Lay out all of the 2" x 4" boards on a level surface.
2. Using the 1-1/4" spade drill bit, drill out (3) 1/2" deep countersunk holes as shown in. SEE FIGURE 9a.
3. Using the 5/16" auger drill bit, drill out the center of every countersunk hole you created in the previous step, as shown in SEE FIGURE 9b

A-2. MULTI-PANEL SUB WALL PREPARATION

1. Lay out all of the 2" x 4" and 2" x 6" boards on a level surface.
2. Using the 1-1/4" spade drill bit, drill out (3) 1/2" deep countersunk holes as shown in. SEE FIGURE 9a.
3. Repeat step 2 with 5 holes for 2" x 6".
4. Using the 5/16" auger drill bit, drill out the center of every countersunk hole you created in the previous step, as shown in FIGURE 9b.

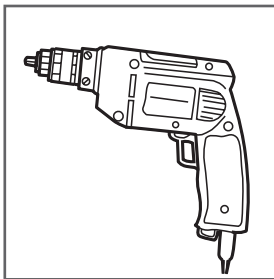

ELECTRIC DRILL

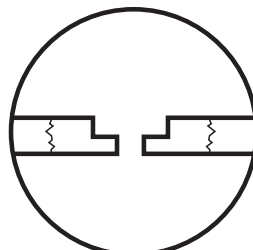

SIDE VIEW OF COUNTERSUNK HOLE

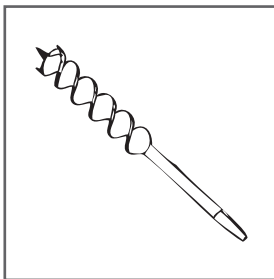

5/16" AUGER DRILL BIT

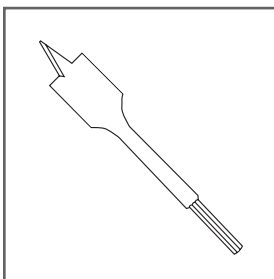

1-1/4" SPADE BIT

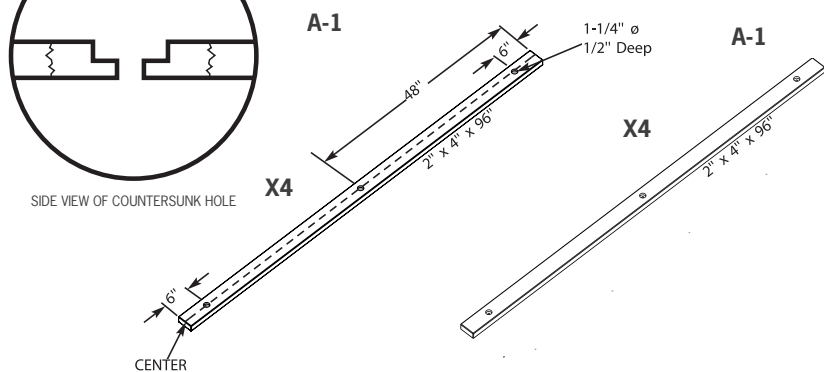

SUB-WALL PREPARATION FIGURE 9a

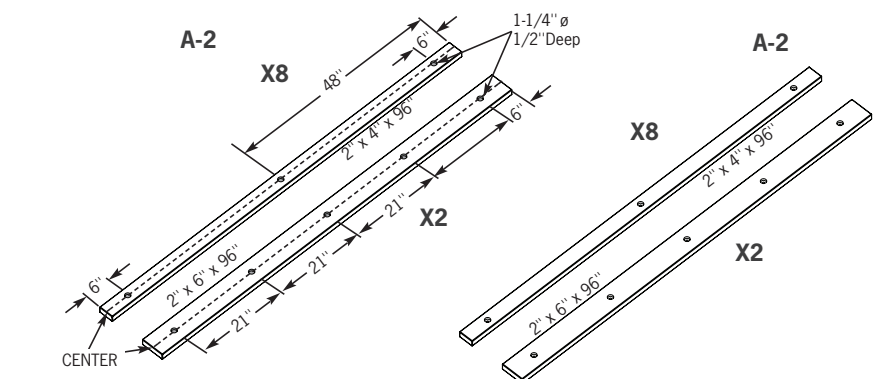

SUB-WALL PREPARATION FIGURE 9b

A-1. SINGLE PANEL SUB WALL PREPARATION

5. Using your stud finder, find and mark (4) horizontal feet of studs. With the studs being 16" on center you should have marked (4) studs with a total distance of 4 feet between the first and last. (Shown for building a 4' wall. See A-2 Sub Wall Preparation for longer configurations) SEE FIGURE 10a.

NOTE: Drywall made invisible for clarity in diagram.

A-2. MULTI PANEL SUB WALL PREPARATION

5. Using your stud finder, find and mark (12) horizontal feet of studs. With the studs being 16" on center you should have marked (10) studs with a total distance of 12 feet between the first and last. (Shown for building a 12' wall. Adjust accordingly for your desired wall size) SEE FIGURE 10b.

NOTE: Drywall made invisible for clarity in diagram.

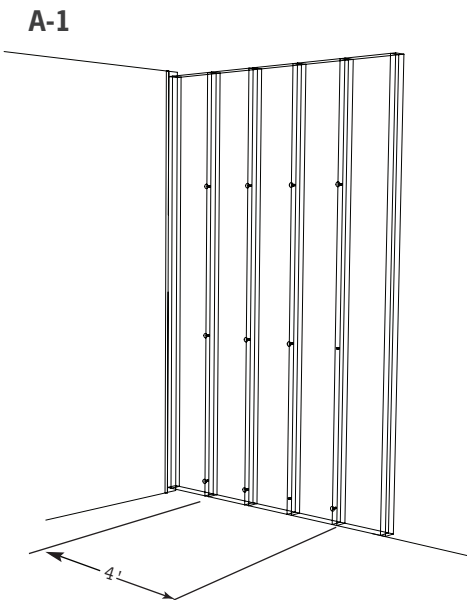

SUB-WALL PREPARATION FIGURE 10a

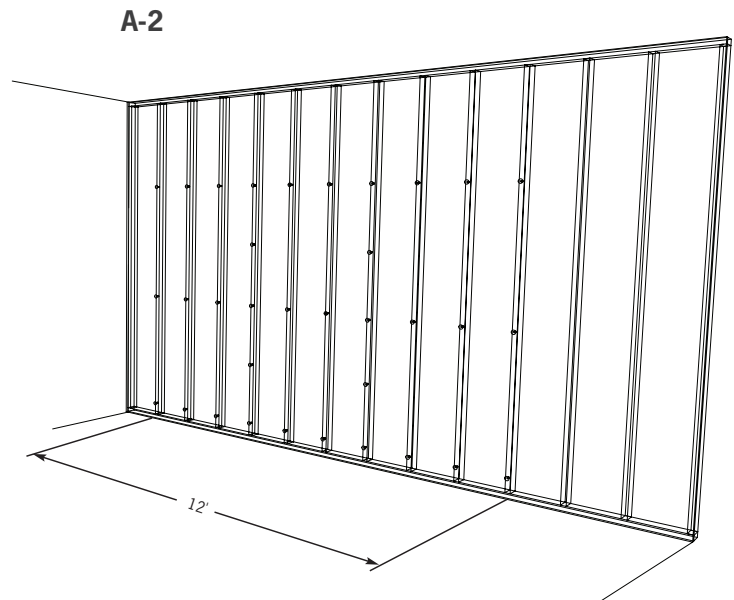

SUB-WALL PREPARATION FIGURE 10b

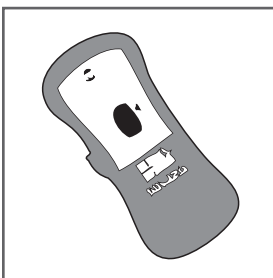

STUD FINDER

B. SINGLE PANEL SUB WALL CONSTRUCTION

1. Working from left to right you will construct the sub wall.
2. Start by taking a 2" x 4" and lining it up with the stud on the farthest left. Level the 2" x 4" and proceed to drill a 5" deep hole through the center hole of the 2" x 4" and into the stud behind the drywall with your 5/16" drill bit. *SEE FIGURE 11a.*
3. Using your drill with a 3/8" socket attached, take a 3/8" lag bolt and drill it into the hole until snug. Repeat this process on the #2, #3, #4
4. Note layout pattern. *SEE FIGURE 11b.*
5. Congratulations! Your Sub Wall is complete.

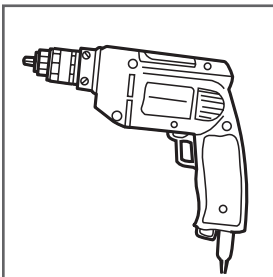

ELECTRIC DRILL

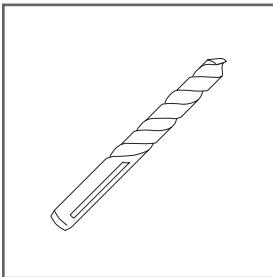

5/16" DRILL BIT

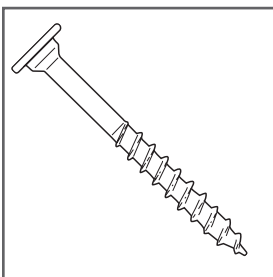

3/8" LAG SCREW

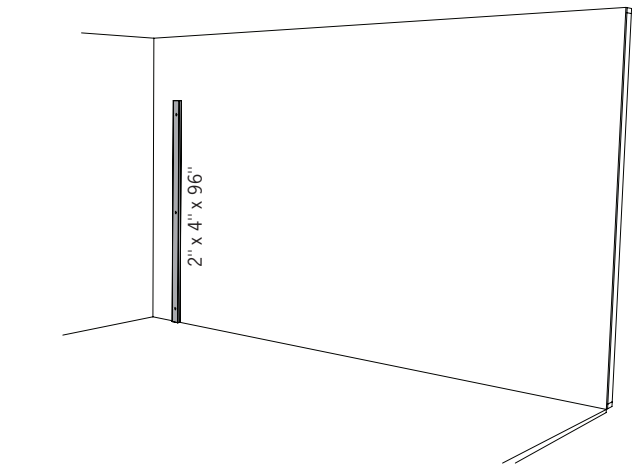

SUB-WALL CONSTRUCTION FIGURE 11a

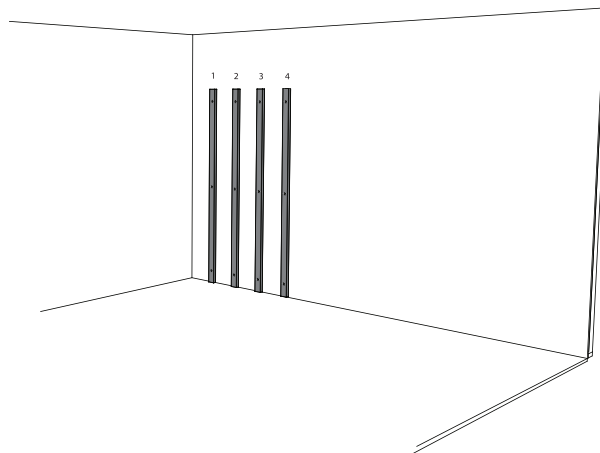

SUB-WALL CONSTRUCTION FIGURE 11b

B. MULTI-PANEL SUB WALL CONSTRUCTION

1. Working from left to right you will construct the sub wall.
2. Start by taking a 2" x 4" and lining it up with the stud on the farthest left. Level the 2" x 4" and proceed to drill a 5" deep hole through the center hole of the 2" x 4" and into the stud behind the drywall with your 5/16" drill bit. *SEE FIGURE 11a.*
3. Using your drill with a 3/8" socket attached, take a 3/8" lag bolt and drill it into the hole until snug. Repeat this process on the #2, #3, #5, #6, #8, #9 and #10 studs. Note layout pattern. *SEE FIGURE 11b.*
5. On the #4 and the #7 studs, repeat the previous steps using the (2) 2" x 6" boards, using the additional counter sunk holes for additional Lag Bolts. *SEE FIGURE 12.*
6. Congratulations! Your Sub Wall is complete.

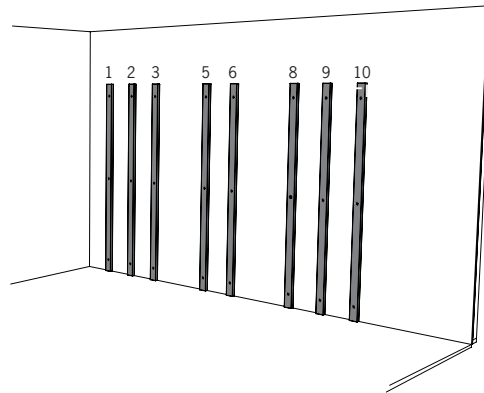

SUB-WALL CONSTRUCTION FIGURE 12a

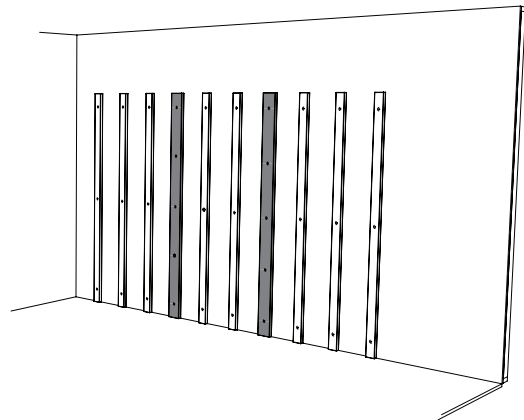

SUB-WALL CONSTRUCTION FIGURE 12b

C. INSTALLATION OF CLIMBING PANELS

1. Working from bottom to top, left to right, you will now install the panels for your climbing wall. Align the left side of a panel with the left side of the left most 2" x 4". SEE FIGURE 13a.
2. Level the Panel. Sink (1) #8 1-3/4" screws through the panel into the 2" x 4" using your drill with the Phillips head drill bit.
3. Secure the panel to the (4) sub wall boards using (1) #8 screw every 12".
4. For multiple panels, repeat the previous steps for the remaining panels. SEE FIGURE 13b.
5. Congratulations! Your climbing wall is now installed and you are ready to add the finishing touches to it.

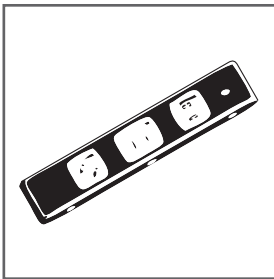

LEVEL

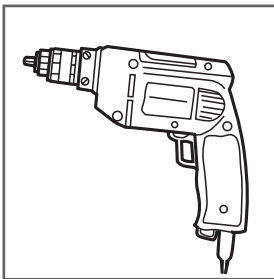

ELECTRIC DRILL

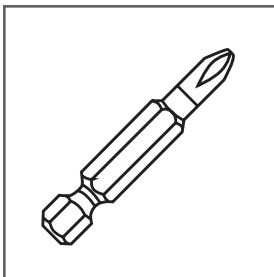

PHILLIPS BIT

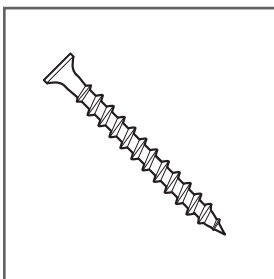

1-3/4" SCREWS

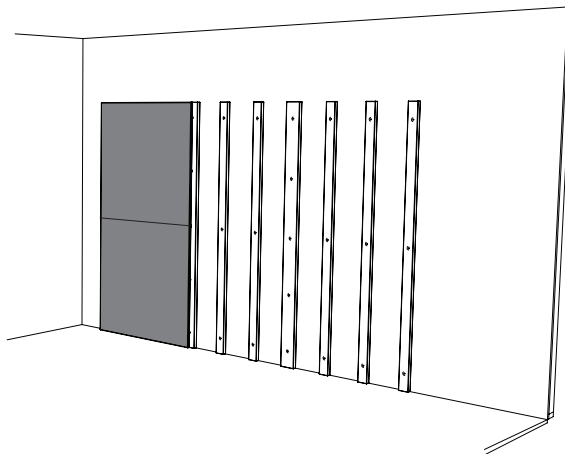

CLIMBING PANEL INSTALLATION FIGURE 13a

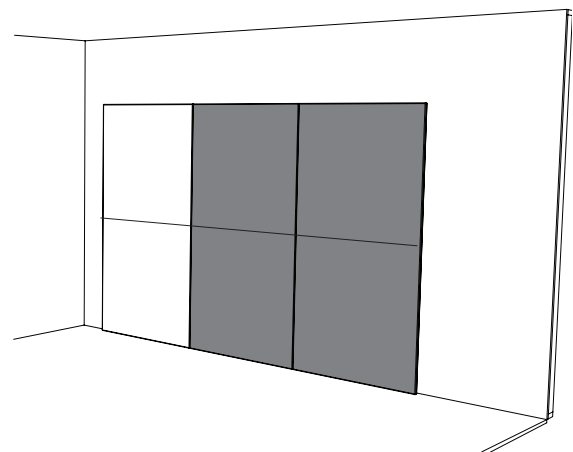

CLIMBING PANEL INSTALLATION FIGURE 13b

D. INSTALLATION OF RED-RELIEF LINE®

1. Using the provided hardware, attach the Red-Relief Line® to the panels at a distance of 3'-31/2' from the floor as shown in *FIGURE 14a*
- 1 The individual pieces of the Red-Relief Line should be touching one another and span the full length of the wall. *SEE FIGURE 14b.)*
2. **Not included with Superior Wall panels.*

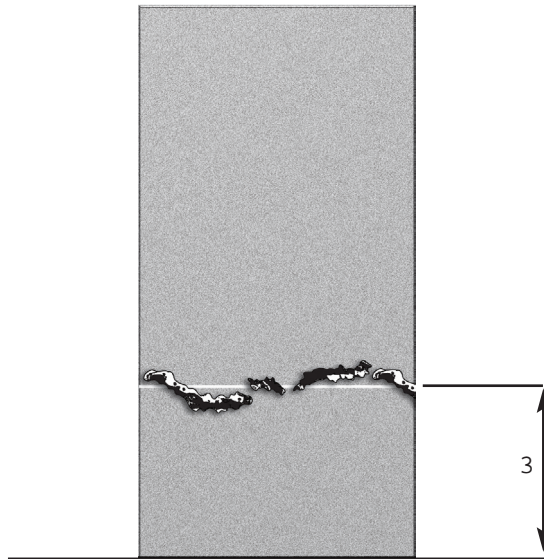

RED RELIEF LINE INSTALLATION FIGURE 14aa

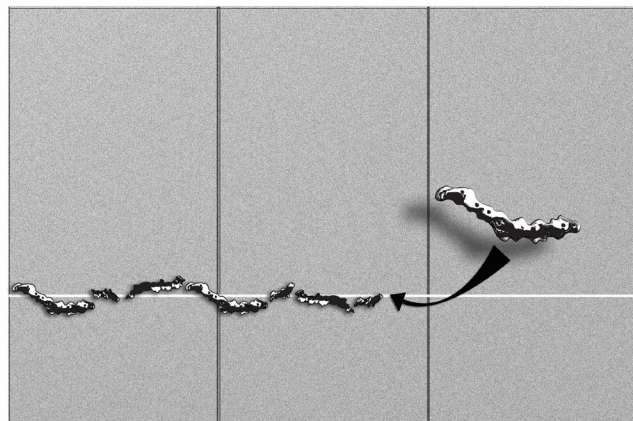

RED RELIEF LINE INSTALLATION FIGURE 14ba

E. INSTALLATION OF HAND HOLDS

1. Place the Hand Hold over the desired hole (T-nut) in your wall, lining up the hand hold with the holes in the climbing wall.
2. Insert hex socket bolt through the hand hold and into the climbing wall.
3. Using the included allen wrench, gently start threading the bolt into the T-nut. Take care not to cross-thread the T-nuts.
4. If you feel resistance while starting to thread the bolt, **stop**, remove the bolt and readjust the hand hold and bolt angle. If you power through the resistance, the bolt and t-nut will become cross-threaded and be locked together. This will cause the hand hold to spin, making the hold unusable.
5. When the bolt threads are started properly, continue threading the bolt until it becomes tight, then give another 3/4 of a turn.
6. Repeat steps 1 through 3 for the remainder of your hand holds.

TIP: For best results, spread the different hand holds out evenly across your wall, separating hand holds by color and size. This will make your wall more useful and interesting.

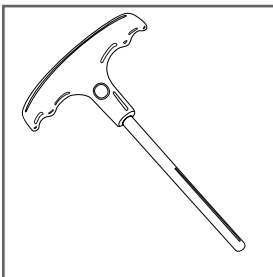

5/16" T-HANDLE ALLEN WRENCH

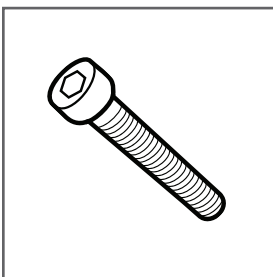

3/8" X 1-3/4" HEX SOCKET BOLTS

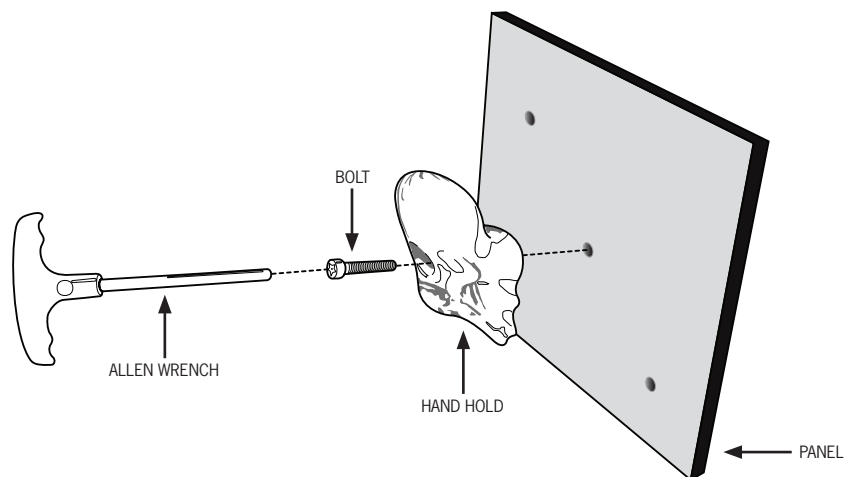

HAND HOLD INSTALLATION FIGURE 15

Placing Your Hand Holds

WHEN CHOOSING THE LOCATIONS OF YOUR HAND HOLDS, KEEP THESE FEW THINGS IN MIND:

- What age climber will be using the wall? Is there a hand/foot hold for the shorter climber and the taller climber?
- Make sure the hand and foot hold moves require the climber to move up and down, not just straight across on the wall.
- Are the holds in the beginning and end of the wall positioned to allow climbers to get on and off the wall easily?
- Make sure the green holds are set as an easy route, yellow should be medium and red should be set as harder routes.
- To make a more challenging climbing wall, position the hand holds so that they are more challenging to grip or step on. (Each hold has a variety of ways in which it can be positioned to offer variety.)
- Consider using the larger holds below the Red Relief Line® (if applicable), to be used as foot holds.

F. INSTALLATION OF THE MAT LOCKING® SYSTEM

1. Lay mats on the floor so that the bottom straps are closest to the wall and line up with the T-nuts on the wall. Attach the bottom straps to the climbing wall using the bolts and security wrench provided. Choose the grommet hole that allows the strap to have some slack - you may need to angle the straps to reach a nearby T-nut.

2. With the bottom straps attached to the wall, stand the mats up against the wall.

Important note: The Cordless Mat Locking System is designed for the mats to rest on the floor. Hanging the mats off the floor will shorten their life and make them much harder to use.

3. Hook the loop of the nylon webbing over a Mat Locking Hold and hold it in the correct position on the climbing wall. Make sure the loops are not pulled too tight, as this will make the locking/unlocking process more difficult. Where the two mats come together, pass one loop through the other before hooking it over the Mat Lock Hold.
4. Using a drill with a #2 Phillips head bit, screw the three 1-5/8" screws through the Mat Lock Hold and into the climbing wall, starting with the top mounting hole first, as shown in *FIGURE 16*.
5. Repeat steps #3–4 to install the remainder of the Mat Lock Holds on the wall.

1. Starting with the first Mat Lock Hold, slide the red slider up into the 'locked' position as shown in *FIGURE 16*. Tighten with security wrench.
2. Repeat step #6 for the remainder of the Mat Lock Holds.

CONGRATULATIONS! Your traverse climbing wall is complete.

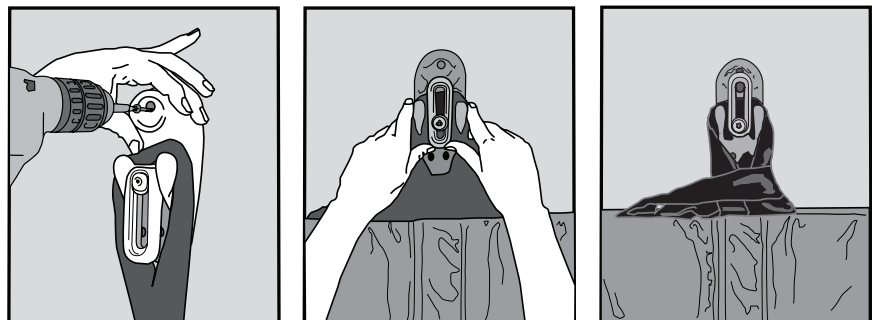

HAND HOLD INSTALLATION FIGURE 16

Care & Maintenance

The proper care and maintenance of your climbing wall is essential and is your responsibility. Inspect your climbing wall, its components and protective surfacing on a regular basis. These inspections should include, but are not limited to the lists that follow.

SURFACE

- Panels should be installed according to installation instructions.
- Check panels to make sure they are in good condition and show no signs of damage.
- Check each panel's adherence to the wall. Tighten only when they are loose. Do not overtighten!
- Check for sharp points and edges.
- Remove or repair any damaged wall areas.

HAND HOLDS

- Hand Holds should be mounted according to installation instructions.
- Observe holds for signs of stress or breakage.
- Remove and replace any damaged holds.
- Check hand holds for looseness and tighten. Do not overtighten!
- Wash hand holds periodically to remove oils, stains and other residue. Use mild soap and water with a soft bristle brush. Towel dry washed holds then air dry for 24 hours to ensure complete drying.
Note: Hand Holds are also dishwasher safe!
- Inspect climbing routes for unsafe maneuvers. Make sure all routes are reviewed carefully before they are climbed.

MATS

- Mats should be used for traverse climbing activities only.
- Mats are not to be used as tumbling, crash or landing mats.
- Inspect mats for damage and proper positioning before use.
- Check mats for tears, soft spots, separation of foam and fatigue (failure to perform adequately).
- Remove defective mats immediately and adjust activity accordingly.
- Mats should extend 6' from all climbing surfaces.
- Never place objects on mats while people are climbing.

Climbing Wall Rules & Supervisor Guidelines

BEFORE CLIMBING:

- Supervision is required
- Protective mat surfacing must be in place
- Remove all jewelry

DURING CLIMBING:

- Climb safely
- Step down from the wall
- No jumping
- No climbing around, over or under another climber
- Have fun!

AFTER CLIMBING:

- Step away from the mat upon completion of your climb

Questions? Concerns? Comments?

**Call our Customer Service Department
at 1.800.476.7366**

Monday - Friday | 8:30 AM - 5:00 PM (CST)



TOLL FREE 1-800-476-7366 | VOICE 651-665-9131 | FAX 651-665-9130 | INFO@EVERLASTCLIMBING.COM
WWW.EVERLASTCLIMBING.COM | 1335 MENDOTA HEIGHTS ROAD, MENDOTA HEIGHTS, MN 55120