

- Please check your product packaging to make sure the included accessories are in the “list of standard accessories”. If any parts are missing, please contact your local dealer immediately.
- Do not allow any sharp objects to come in contact with the cabinet, as it will scratch the surface.
- Continuous and prolonged exposure to direct sunlight may cause discoloration to the wood.
- Do not put any hot appliances directly on or near the cabinet.
- Please avoid using cleaning products that contain bleach or ammonia.
- Wood surfaces should only be cleaned with wood care products such as soapy water or furniture polish.



30" WINECK SERIES



INSTALLATION

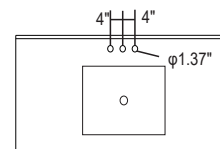
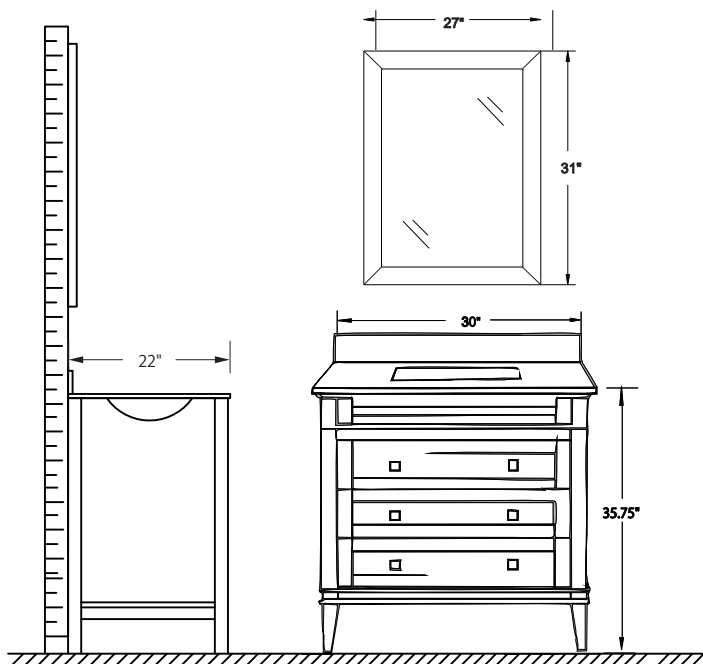

MAIN BODY PARTS

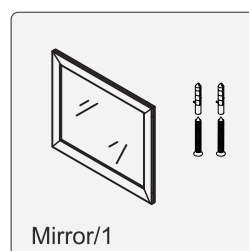
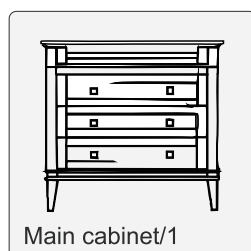

INSTALLATION PARTS





Tape



Pencil

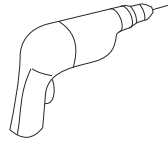

Impact Drill



Levelling Instrument



Screw driver

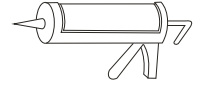

Glass Glue Gun

DRAWER ASSEMBLY AND REMOVAL(WITH PEG)

Fix the slide onto the cabinet.

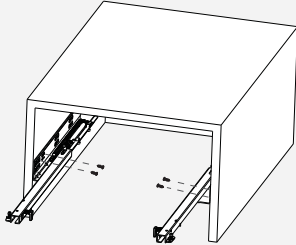

Pull out the drawer member of the slide from the cabinet, lay the drawer onto the slide.

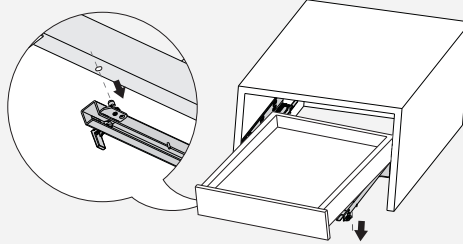

Press the locking pin into the drawer side to lock the position of the drawer.

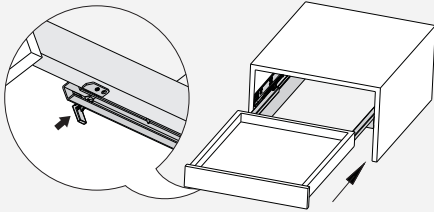

For removal, pull out the locking pin from the drawer side. Lift the drawer and pull it out from the cabinet.

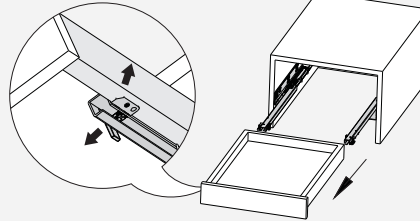

INSTALLATION INSTRUCTIONS

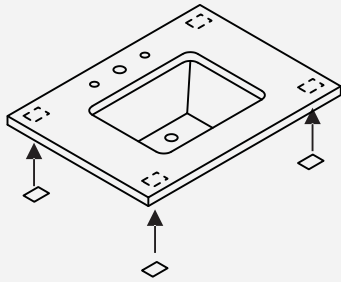

① Attached Gasket



② Install Counter Top.

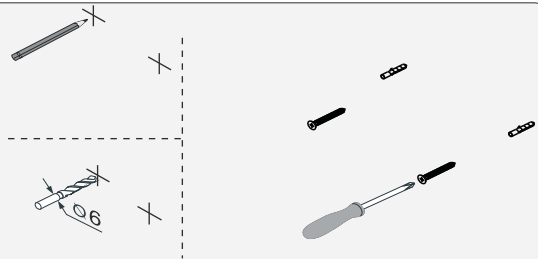

③ Fix the mirror

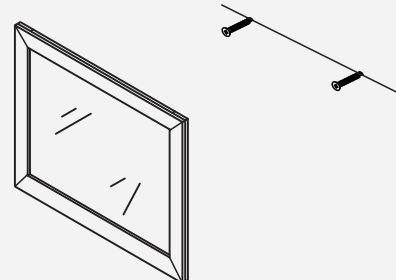

④ Hang the mirror

HAVE QUESTIONS? CALL 1-844-44-ANZZI OR VISIT ANZZI.COM