









OUTDOOR FIRE PIT

MODEL # WLF-HEX

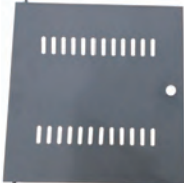





Questions, problems, missing parts? Before returning to your retailer, call our customer service department at **1-888-775-1330**, 7 a.m. - 4 p.m., PST, Monday - Friday.

PACKAGE CONTENTS

NUMBER	PART	PHOTO	QUANTITY
A	Base Plate		1
B	Door Bracket		1
C	Bracket Post		6
D	Door		1
E	Panel		5
F	Table		1
G	Burner		1
H	Angle Iron		4
I	Knob		1

PACKAGE CONTENTS

NUMBER	PART LIST	PHOTO	QUANTITY
AA	M8X16 Screw and Washer		4
BB	M4X10 Screw		3
CC	Wrench		1
DD	Fire Glass		

SAFETY INFORMATION

Please read and understand this entire manual before attempting to assemble, operate or install the product. If you have any questions regarding the product, please call customer service at **1-888-775-1330**, 7 a.m. - 4 p.m., PST, Monday - Friday.

This manual contains important information about the assembly, operation and maintenance of this patio heater. General safety information is presented in these first few pages and is also located throughout the manual. Keep this manual for future reference and to educate new users of this product. This manual should be read in conjunction with the labeling on the product. Safety precautions are essential when any mechanical or propane fueled equipment is involved. These precautions are necessary when using, storing, and servicing. Using this equipment with the respect and caution demanded will reduce the possibilities of personal injury or property damage. The following symbols shown below are used extensively throughout this manual. Always heed these precautions, as they are essential when using any mechanical or fueled equipment.

DANGER

DANGER indicates an imminently hazardous situation which, if not avoided, will result in death or serious injury.

DANGER

Failure to comply with the precautions and instructions provided with this heater can result in death, serious bodily injury and property loss or damage from hazards of fire, explosion, burn, asphyxiation, and/or carbon monoxide poisoning. Only persons who can understand and follow the instructions should use or service this heater.

DANGER

FOR YOUR SAFETY

If you smell gas:

1. Shut off gas to the appliance.
2. Extinguish any open flame.
3. If odor continues, keep away from the appliance and immediately call you gas supplier or fire department.

SAFETY INFORMATION

DANGER

- EXPLOSION - FIRE HAZARD
- Keep solid combustibles, such as building materials, paper or cardboard, a safe distance away from the heater as recommended by the instructions.
- Provide adequate clearances around air openings into the combustion chamber.
- Never use the fire pit in spaces which do or may contain volatile or airborne combustibles, or products such as gasoline, solvents, paint thinner, dust particles or unknown chemicals.
- During operation, this product can be a source of ignition. Keep heater area clear and free from combustible materials, gasoline, paint thinner, cleaning solvents and other flammable vapors and liquids. Do not use fire pit in areas with high dust content.

DANGER

- EXPLOSION - FIRE HAZARD
- Never store propane near high heat, open flames, pilot lights, direct sunlight, other ignition sources or where temperatures exceed 120 degrees F (49°C).
- Propane vapors are heavier than air and can accumulate in low places. If you smell gas, leave the area immediately.
- Never install or remove propane cylinder while heater is lighted, near flame, pilot lights, other ignition sources or while heater is hot to touch.
- This heater is red hot during use and can ignite flammables too close to the burner. Keep flammables at least 3 feet from sides & 2 feet from top. Keep gasoline and other flammable liquids and vapors well away from heater.
- Store the propane cylinder outdoors in a well ventilated space out of reach of children. Never store the propane cylinder in an enclosed area (house, garage, etc.). If heater is to be stored indoors, disconnect the propane cylinder for outdoor storage.

WARNING

We cannot foresee every use which may be made of our heaters. Check with your local fire safety authority if you have questions about heater use. Other standards govern the use of fuel gases and heat producing products for specific uses. Your local authorities can advise you about these. If no local codes exist, follow National Fuel Gas Code, ANSI Z223.1. In Canada, installation must conform to local codes. If no local codes exist, follow the current National standards of CANADA CAN/CGA-B 149.2.

DANGER

- CARBON MONOXIDE HAZARD
- This heater is a combustion appliance. All combustion appliances produce carbon monoxide (CO) during the combustion process. This product is designed to produce extremely minute, non-hazardous amounts of CO if used and maintained in accordance with all warnings and instructions. Do not block air flow into or out of the heater.
- Carbon Monoxide (CO) poisoning produces flu-like symptoms, watery eyes, headaches, dizziness, fatigue and possibly death. You can't see it and you can't smell it. It's an invisible killer. If these symptoms are present during operation of this product get fresh air immediately!
- For outdoor use only.
- Never use inside house, or other unventilated or enclosed areas.
- This heater consumes air (oxygen). Do not use in unventilated or enclosed areas to avoid endangering your life.

WARNING

WARNING indicates an imminently hazardous situation which, if not avoided, will result in death or serious injury.

WARNING

Do not store or use gasoline or other flammable vapors and liquids in the vicinity of this or any other appliance. An LP-cylinder not connected for use shall not be stored in the vicinity of this or any other appliance.

WARNING: For Outdoor Use Only

DANGER



CARBON MONOXIDE HAZARD
This appliance can produce carbon monoxide which has no odor. Using it in an enclosed space can kill you. Never use this appliance in an enclosed space such as a camper, tent or home.

WARNING

Improper installation, adjustment, alteration, service or maintenance can cause property damage, injury or death. Read the installation, operation and maintenance instructions thoroughly before installing or servicing this equipment.

SAFETY INFORMATION

WARNING

California Proposition 65
Combustion by-products produced when using this product contain chemicals known to the State of California to cause cancer, birth defects, and other reproductive harm.

WARNING

BURN HAZARD

- Never leave heater unattended when hot or in use.
- Keep out of reach of children.

WARNING

Certain materials or items, when stored under the heater, will be subjected to radiant heat and could be seriously damaged.

CAUTION

SERVICE SAFETY

- Keep all connections and fittings clean. Make sure propane cylinder valve outlet is clean.
- During set up, check all connections and fittings for leaks using soapy water. Never use a flame.
- Use as a heating appliance only. Never alter in any way or use with any device.

CAUTION

CAUTION indicates an imminently hazardous situation which, if not avoided, may result in minor or moderate personal injury, or property damage.

WARNING

- This product is fueled by propane gas. Propane gas is invisible, odorless, and flammable. An odorant is normally added to help detect leaks and can be described as a "rotten egg" smell. The odorant can fade over time so leaking gas is not always detectable by smell alone.
- Propane gas is heavier than air and leaking propane will sink to the lowest level possible. It can ignite by ignition sources including matches, lighters, sparks or open flames of any kind many feet away from the original leak. Use only propane gas set up for vapor withdrawal.
- Store or use propane gas in compliance with local ordinances and codes or with ANSI/NFPA 58. Turn off propane when not in use.

WARNING

- Alert children and adults to the hazards of high surface temperatures. Stay away from these surfaces to avoid burning skin or igniting clothing.
- Carefully supervise young children when in the vicinity of the heater.
- Do not hang clothing or any other flammable materials from the heater, or place on or near the heater.
- Replace any guard or protective device removed for servicing the appliance prior to placing back in service.
- Installation and repair should be done by a qualified service person. The heater should be inspected before use and annually by a qualified service person. More frequent cleaning may be required as necessary. It is imperative that the control compartment, burners, and circulating air passageway of the appliance be kept clean.

PREPARATION

Before beginning assembly of product, make sure all parts are present. Compare parts with package contents list and hardware contents above. If any part is missing or damaged, do not attempt to assemble the product. Contact customer service for replacement parts.

Estimated Assembly Time: 60 minutes

Tools Required for Assembly (not included):

Phillips screwdriver w/ medium blade. Leak Detection Solution.

Step 1: Open the bracket post box and remove all screws from posts. Put the posts beside the base plate (A) as shown in figure 1-1. Attach the posts to the base plate with the removed screws (C1, C2, C5, C6). Use wrench (CC) to fasten them.

1

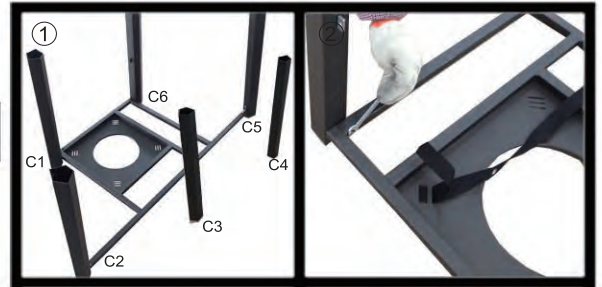

Step 2: Assemble the five side panels (E) into the brackets with 12pcs M6x12 screws (CC). **Note:** Panels go between posts (C1-C2, C2-C3, C3-C4, C5-C6).

2



Step 3: Attach the door brackets (B) to the bracket post with 2pcs screws only. **Note:** Fasten to the hole marked C1.

3



ASSEMBLY INSTRUCTIONS

Step 4: Remove the screw and washer from the knob (I). Attach the knob to the door (D) using the screw and washer.

4

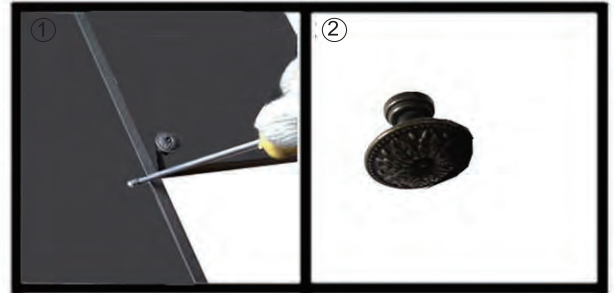

Step 5: Place the door (D) into the frame and use 2pcs screws to fasten the door bracket.

5



Step 6: Attach the Angle Irons (H) to the bracket posts marked (C1, C2, C4, C5) with 8pcs screws. Place the table (F) face down. Then turn over the fire pit body onto the the table(F).

6



Note: Door side should be pointed to table side marked "DOOR SIDE".

ASSEMBLY INSTRUCTIONS

Step 7: Attach the Angle Irons (H) to the table using 4 sets of M8X16 Screws and Washers (AA). Use the Wrench (CC) to tighten them.

7



Step 8: Turn the fire pit right side up. Put the burner (G) into the table hole and use 3pcs M4X10 screws (BB) to fasten it.

Note: Burner control knob should be facing the door.

8

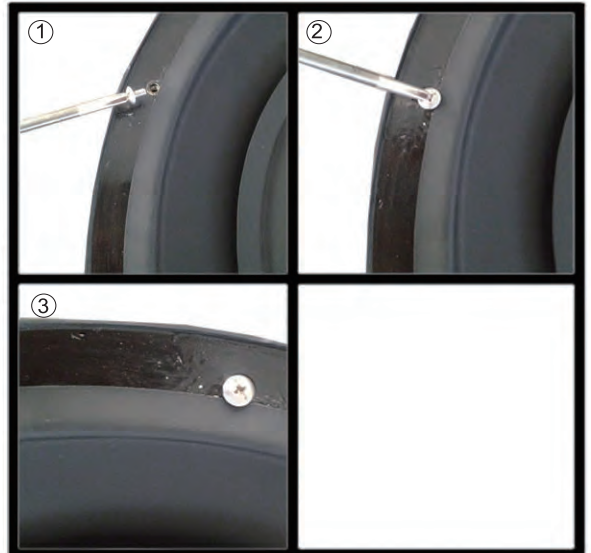

Step 9: The fire pit is complete.

9



ASSEMBLY INSTRUCTIONS

Step 10: Empty the fire glass into the burner. (Wear gloves to prevent cuts.)

10



ASSEMBLY INSTRUCTIONS

A dented, rusted or damaged propane cylinder may be hazardous and should be checked by your cylinder supplier. Never use a propane cylinder with a damaged valve connection.

The propane cylinder must be constructed and marked in accordance with the specifications for LP gas cylinders of the U.S. Department of Transportation (DOT) or the standard for cylinders, spheres and tubes for transportation of dangerous goods and commission, CAN/CSA-B339.

The cylinder must have a listed overfilling prevention device.

The cylinder must have a connection device compatible with the connection for the appliance.

The cylinder used must include a collar to protect the cylinder valve.

Never connect an unregulated propane cylinder to the heater.

Attach regulator to cylinder. Complete attachment.

Install cylinder.

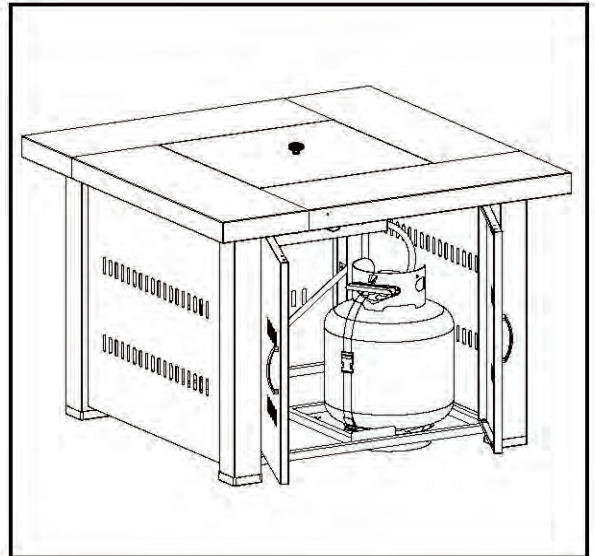
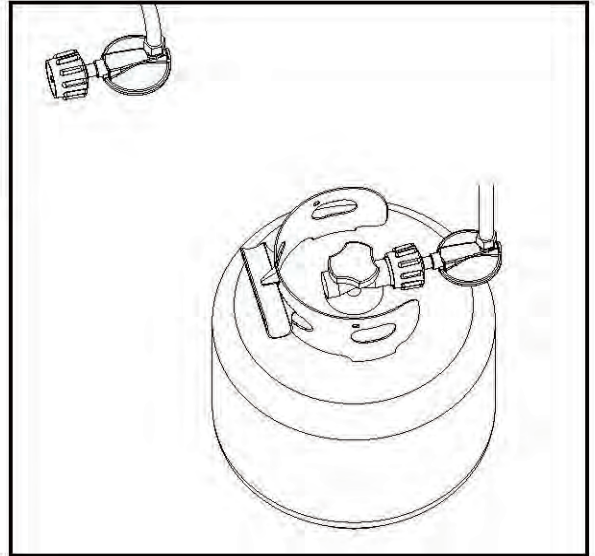

- Do not store a spare LP-gas cylinder under or near this appliance;
- Never fill the cylinder beyond 80 percent full;
- Place the dust cap on the cylinder valve outlet whenever the cylinder is not in use. Only install the type of dust cap on the cylinder valve that is provided with the cylinder valve. Other type of caps or plugs may result in leakage of propane.

ATTENTION: THIS PRODUCT IS NOT FOR COMMERCIAL USE INTENDED FOR RESIDENTIAL USE ONLY.

Do not sit or stand on this table .

Keep children away during assembly, This item contains small parts which can be swallowed by children.

Do not use indoors and inside any enclosure.

Retain the assembly instruction for future reference.

Installer – Please leave these instruction with the owner.

Please quote following FQC NO. when contacting service center.

OPERATION INSTRUCTIONS

Leak Check

WARNING

- Perform all leak tests outdoors.
- Extinguish all open flames.
- NEVER leak test when smoking.
- Do not use the fire pit until all connections have been leak tested and do not leak.

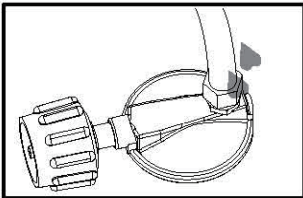

Hose / Regulator
connection

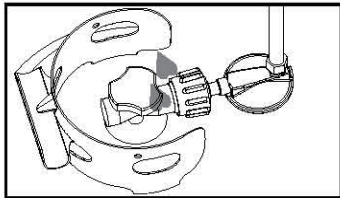

Regulator / Cylinder
connection

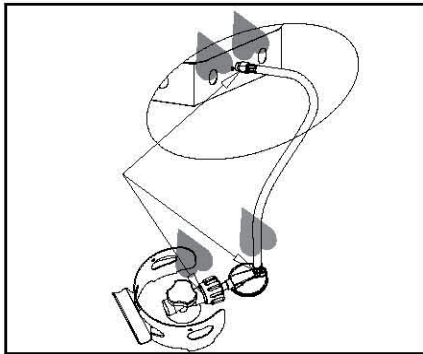

1. Make 2-3 oz. of leak check solution (one part liquid dishwashing detergent and three parts water).
2. Apply several drops of solution where hose attaches to regulator.
3. Apply several drops of solution where regulator connects to cylinder.
4. Make sure all fire pit and light valves are OFF.
5. Turn cylinder valve ON.

If bubbles appear at any connection, there is a leak.

1. Turn cylinder valve OFF.
2. If leak is at hose/regulator connection: tighten connection and perform another leak test. If bubbles continue appearing, the hose should be returned to the place of purchase.
3. If leak is at regulator/cylinder valve connection: disconnect, reconnect, and perform another leak check. If you continue to see bubbles after several attempts, cylinder valve is defective and should be returned to cylinder's place of purchase.

If NO bubbles appear at any connection, the connections are secure.

NOTE: Whenever gas connections are loosened or removed, you must perform a complete leak test. Complete installation.

OPERATION INSTRUCTIONS

⚠ DANGER

- CARBON MONOXIDE HAZARD
- For outdoor use only. Never use inside house, or other unventilated or enclosed areas. This fire pit consumes air (oxygen). Do not use in unventilated or enclosed areas to avoid endangering your life.

⚠ WARNING

Very hot while in a operation!
Never lean over the fireplace while in use.
Do not touch tile of spark guard while the fire pit is in operation, wait until the fire pit has cooled down after use.
Failure to comply with these instructions may result in serious bodily injury.

Caution: Do not attempt to operate until you have read and understand all General Safety Information in this manual and all assembly is complete and leak checks have been performed.

Before Turning Gas Supply ON:

1. Your fire pit was designed and approved for outdoor use only. Do NOT use it inside a building, garage, or any other enclosed area.
2. Make sure surrounding areas are free of combustible materials, gasoline, and other flammable vapors or liquids.
3. Ensure that there is no obstruction to air ventilation. Be sure all gas connections are tight and there are no leaks.
4. Be sure the cylinder cover is clear of debris. Be sure any component removed during assembly or servicing is replaced and fastened prior to starting.

Before Lighting:

1. Fire pit should be thoroughly inspected before each use, and by a qualified service person at least annually. If relighting a hot fire pit, always wait at least 5 minutes.
2. Inspect the hose assembly for evidence of excessive abrasion, cuts, or wear. Suspected areas should be leak tested. If the hose leaks, it must be replaced prior to operation. Only use the replacement hose assembly specified by manufacturer.

Lighting:

- 1) Turn the control knob to the "OFF" position (Figure a).
- 2) Fully open LP cylinder valve.

Note: For initial start or after any cylinder change, hold Control Knob IN for 2 minutes to purge air from gas lines before proceeding.

- 3) Push in gas control knob and turn counterclockwise to "IGNITER" (Figure b) to light the fire pit. If needed, keep depressing and turning control knob counterclockwise until the heater lights (You should hear a clicking sound).

- 4) After fire pit lights, release control knob. Push in and turn the control knob to the "HIGH", then release control knob. If you want a lower temperature, push in the control knob and turn counterclockwise to the "LOW" (Figure c).

Note: If burner fails to remain lit, all valves should be closed and a waiting period of at least 5 minutes should pass before attempting to light.

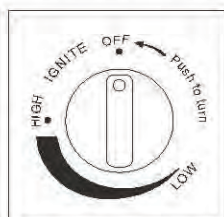

Figure a

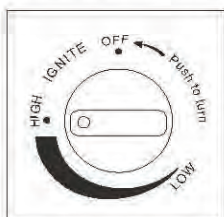

Figure b

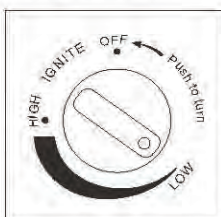
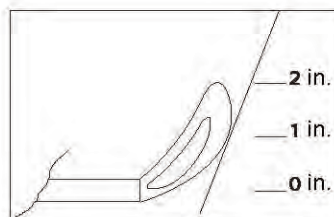
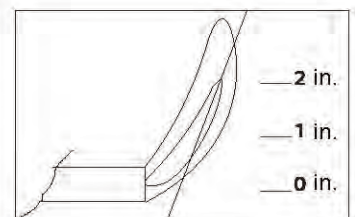

Figure c



Normal



Abnormal

OPERATION INSTRUCTIONS

WARNING

FOR YOUR SAFETY

Be careful when attempting to manually ignite this fire pit. Holding in the control knob for more than 10 seconds before igniting the gas will cause a ball of flame upon ignition.

When fire pit is ON:

Burner will display tongues of blue and yellow flame. These flames should not be yellow or produce thick black smoke, indicating an obstruction of airflow through the burners. The flame should be blue with straight yellow tops. If excessive yellow flame is detected, turn off heater and consult “Troubleshooting” on page 18.

Re-lighting:

1. Turn control knob to OFF.
2. Repeat the “Lighting” steps on prior page.

WARNING

FOR YOUR SAFETY

Fire pit will be hot after use. Handle with extreme care.

Shut Down:

1. To extinguish burner depress control knob and continue to turn it clockwise to OFF.
2. Turn cylinder valve clockwise to OFF and disconnect regulator when heater is not in use.

Operation Checklist

For a safe and pleasurable heating experience, perform this check before each use.

Before Operating:

1. I am familiar with entire owner’s manual and understand all precautions noted.
2. All components are properly assembled, intact and operable.
3. No alterations have been made.
4. All gas connections are secure and do not leak.
5. Wind velocity is below 10 mph.
6. Unit will operate at reduced efficiency below 40°F.
7. Fire pit is outdoors (outside any enclosure).
8. There is adequate fresh air ventilation.

OPERATION INSTRUCTIONS

9. Fire pit is away from gasoline or other flammable liquids or vapors.
10. Fire pit is away from windows, air intake openings, sprinklers and other water sources.
11. Fire pit is at least 24 in. on rear and at least 24 in. on sides from combustible materials.
12. Fire pit is on a hard and level surface.
13. There are no signs of spider or insect nests.
14. All burner passages are clear.
15. All air circulation passages are clear.
16. *Children and adults should be alerted to the hazards of high surface temperatures and should stay away to avoid burns or clothing ignition.*
17. *Young children should be carefully supervised when they are in the area of the fire pit.*
18. *Clothing or other protective material should not be hung from the fire pit, or placed on or near the fire pit.*
19. *Any guard or other protective device removed for servicing the fire pit must be replaced prior to operating the fire pit.*
20. *Installation and repair should be done by a qualified service person. The fire pit should be inspected before use and at least annually by a qualified service person.*
21. *More frequent cleaning may be required as necessary. It is imperative that control compartment, burner and circulating air passageways of the fire pit be kept clean.*

After Operation

1. Gas control is in OFF position.
2. Gas Tank valve is OFF.
3. Disconnect Gas line.

CARE AND MAINTENANCE

WARNING

FOR YOUR SAFETY:

- Do NOT touch or move fire pit for at least 45 minutes after use.
- Reflector is hot to the touch.
- Allow reflector to cool before touching.

To enjoy years of outstanding performance from your fire pit, make sure you perform the following maintenance activities on a regular basis:

Keep exterior surfaces clean.

1. Use warm soapy water for cleaning. Never use flammable or corrosive cleaning agents.
2. While cleaning your unit, be sure to keep the area around the burner dry at all times. Do not submerge the control valve assembly. If the gas control is submerged in water, do NOT use it. It must be replaced.
 - a. Keep the appliance area clear and free from combustible materials, gasoline and other flammable vapors and liquids.
 - b. Do not obstruct the flow of combustion and ventilation air.
 - c. Keep the ventilation opening(s) of the cylinder enclosure free and clear from debris.
3. Air flow must be unobstructed. Keep controls, burner, and circulating air passageways clean. Signs of possible blockage include:

CARE AND MAINTENANCE

- Gas odor with extreme yellow tipping of flame.
- Fire pit does NOT reach the desired temperature.
- Fire pit glow is excessively uneven.
- Fire pit makes popping noises.
- Spiders and insects can nest in burner or orifices. This dangerous condition can damage fire pit and render it unsafe for use. Clean burner holes by using a heavy-duty pipe cleaner. Compressed air may help clear away smaller particles.
- Carbon deposits may create a fire hazard. Clean dome and burner screen with warm soapy water if any carbon deposits develop.



Note: *In a salt-air environment (such as near an ocean), corrosion occurs more quickly than normal. Frequently check for corroded areas and repair them promptly.*

TIP:

Use high-quality automobile wax to help maintain the appearance of your fire pit. Apply to exterior surfaces from the pole down. Do not apply to emitter screen or domes.

Storage

Between uses:

- Turn Control Knob OFF.
- Disconnect LP source.
- Store fire pit upright in an area sheltered from direct contact with inclement weather (such as rain, sleet, hail, snow, dust and debris).
- If desired, cover fire pit to protect exterior surfaces and to help prevent build-up in air passages.

Note: *Wait until fire pit is cool before covering.*

During periods of extended inactivity or when transporting:

- Turn Control Knob OFF.
- Disconnect LP source and move to a secure, well-ventilated location outdoors.
- Store fire pit upright in an area sheltered from direct contact with inclement weather (such as rain, sleet, hail, snow, dust and debris).
- If desired, cover fire pit to protect exterior surfaces and to help prevent build-up in air passages.

Never leave LP cylinder exposed to direct sunlight or excessive heat.

Note: *Wait until fire pit is cool before covering.*

Service

Only a qualified service person should repair gas passages and associated components.

Caution: *Always allow fire pit to cool before attempting service.*

TROUBLESHOOTING

If you have any questions regarding the product, please call customer service at **1-888-775-1330**, 7 a.m. - 4 p.m. (PST), Monday - Friday.

PROBLEM	POSSIBLE CAUSE	CORRECTIVE ACTION
Burner won't light	Propane cylinder is frosted over	Wait until the propane cylinder warms up and becomes unfrosted
	Blockage in orifice	Clear blockage
	Control knob is not in ON position	Turn control knob to ON
Burner flame is low	Gas pressure is low	Turn cylinder valve OFF and replace cylinder
	Outdoor temperature is less than 40°F and tank is less than 1/4 full	Use a full cylinder
	Control knob fully ON	Check burner and orifices for blockage
Carbon build-up	Dirt or film on reflector and burner screen	Clean reflector and burner screen
Thick black smoke	Blockage in burner	Remove blockage and clean burner inside and outside

ONE-YEAR LIMITED WARRANTY

CUSTOMERS IN USA

Do not return this product to the store where you purchased it. Please call **1-888-775-1330** for assistance.

CUSTOMERS IN CANADA

IMPORTANT

Only return this product to the store if it was purchased within 90 days. If you have problems after 90 days of purchase, please CALL **1-888-775-1330** DATED PROOF OF PURCHASE REQUIRED FOR WARRANTY SERVICE.

This product is inspected, tested and carefully packaged to minimize the chance of damage during shipment. If a part (excluding light bulbs and fuses*) within one year from the date of purchase proves to be defective in material or fabrication under normal use, the part will be repaired or replaced. The Company's obligation under the warranty is to replace or repair defective parts at our discretion. Any expenses or damage resulting from the installation, removal or transportation of the product will be the responsibility of the owner and are not covered by this warranty. The owner assumes all other risks arising out from the use or misuse of the product. The warranty will be void if the product damage or failure is deemed by the Company to be caused by accident, alteration, misuse, abuse, incorrect installation or removal, or connection to an incorrect power source by the owner. The Company neither assumes, nor authorizes any person or entity to assume for it any obligation or liability associated with its products.

* Light bulbs and fuses are not covered under this warranty.

If you have any questions regarding the warranty or service, please call our toll free number: **1-888-775-1330**.

Distributed by:

AZ Patio Heaters, LLC

Toll Free Number **1-888-775-1330**

Sales Service and Repair

www.azpatioheaters.com

Manufactured by:

Changzhou Wellife Furnace Co.,Ltd.

Liuxiang Village, Zouqu Town, Wujin District,

Changzhou City, Jiangsu Province P.R.China

