

**PERGO XP Install Instructions**

**Tools Required for Installation**

**Common Tools**

Wood Glue  
 Carbide 40T Blade

**Other Tools and Supplies**

Laminate floor tapping block and 5mm (3/16") spacers  
 Finishing Putty  
 Mildew-resistant silicone  
 Felt furniture pads  
 Moisture Meter

**Job Site**

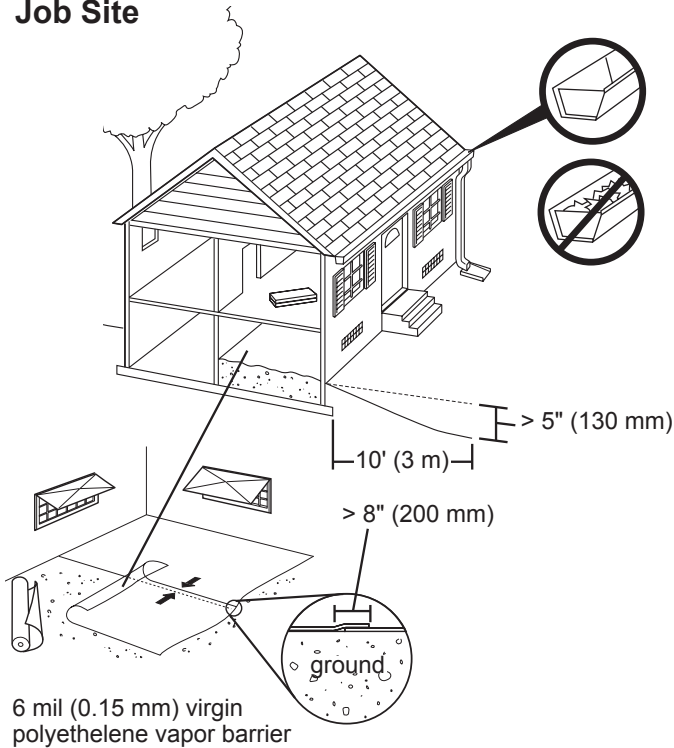

**Site Requirements**

Laminate is a durable floor covering, not intended as structural material. Laminate requires a clean, dry, secure subfloor that meets building codes.

Laminate floor is suitable for use in climate controlled (35-65% RH and 60-85° F) indoor installations only and should not be installed in rooms with floor drains or sump pumps. Laminate floor can be installed above, on or below grade.

A moisture test is strongly recommended to determine if high moisture exists in the subfloor. When using a calcium chloride moisture test for concrete subfloors (ASTM 1869), values must be ≤ 5 lbs/1000ft²/24-hr or <80% with an in situ probe (ASTM F2170). Moisture readings of wood subfloors must be ≤ 12%.

Acceptable job site conditions, including relative humidity and subfloor moisture conditions, must be maintained throughout the lifetime of the flooring.

Laminate flooring is installed as a floating floor and requires the use of T-moldings in doorways 4 ft (1.22m) or less and in rooms 40 feet (12.2 m) or larger in length or width. Floor movement must not be constrained by glue, nails, screws, hardware or other fixed obstructions.

This product must be installed in accordance with these installation instructions.

**For more information, call 1-800-33-PERGO**

# PERGO XP Install Instructions

## Site and Material Preparation

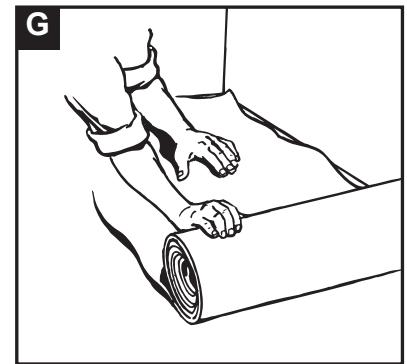
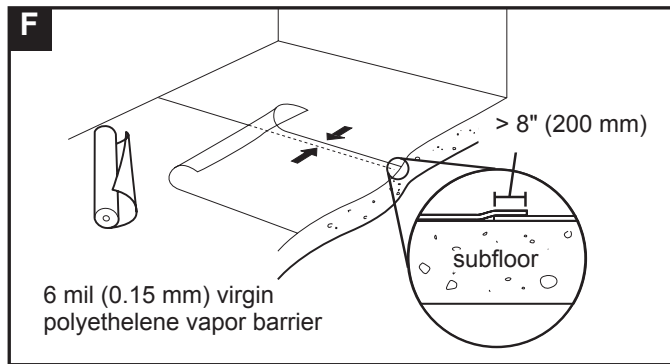
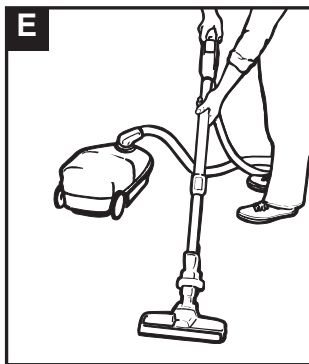
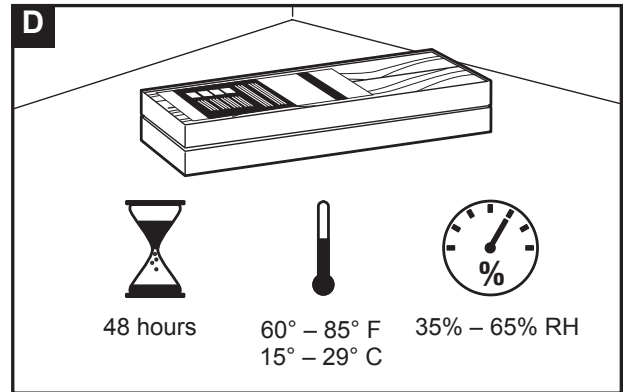
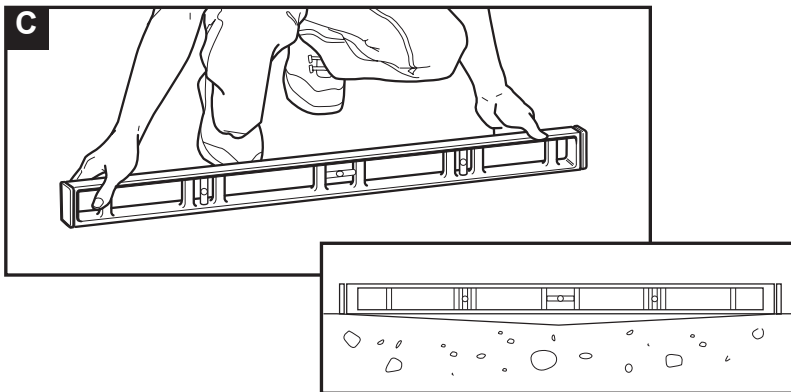
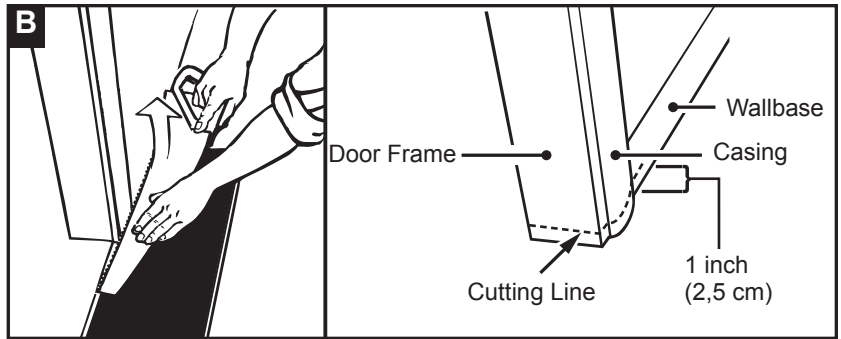
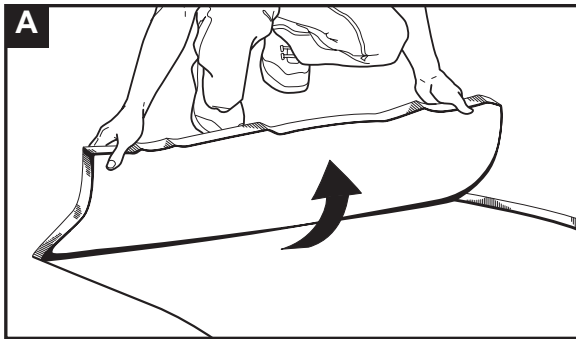

## Site and Material Preparation

- A) Remove carpet and padding. Also remove any wood flooring installed on concrete. Do not remove products unless they are asbestos-free.
- B) Undercut door frame and wallbase. Slide the flooring at least  $\frac{1}{4}$ " underneath the door frame and wallbase. Also leave a concealed  $\frac{3}{8}$ " minimum expansion space under each.
- C) Remove bumps or peaks in subfloor and fill depressions with floor leveling compound to ensure no more than  $\frac{3}{16}$ " unevenness per 10-foot span.
- D) Acclimate unopened product before installation.
- E) Clean debris from subfloor before installation.
- F) For concrete subfloors, install vapor barrier with **overlapped** seams of 8" or more.
- G) For planks without attached underlayment, install over single layer of underlayment appropriate for laminate floors.

# PERGO XP Install Instructions

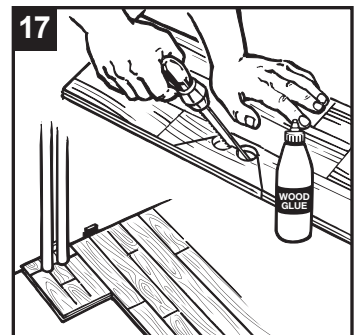
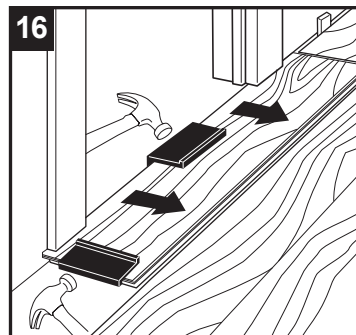
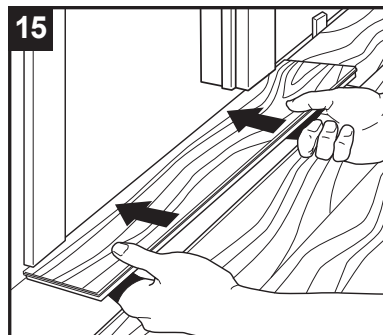
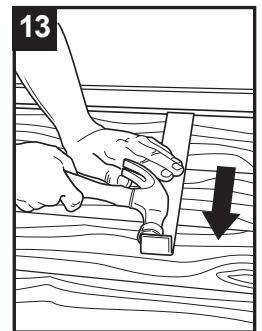
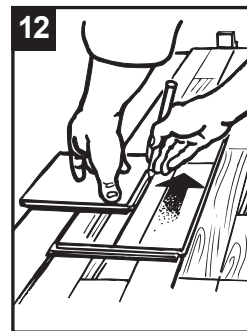
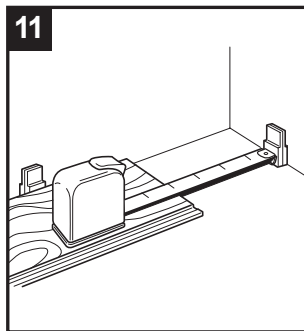
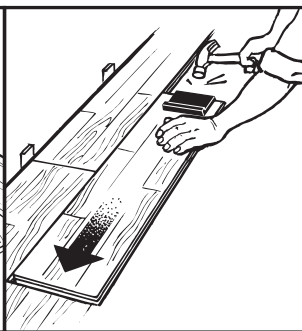
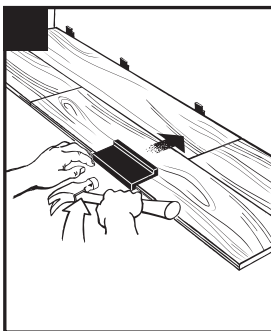
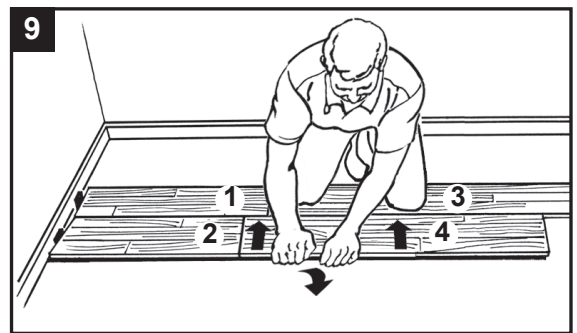
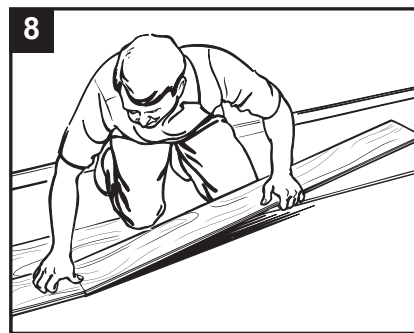
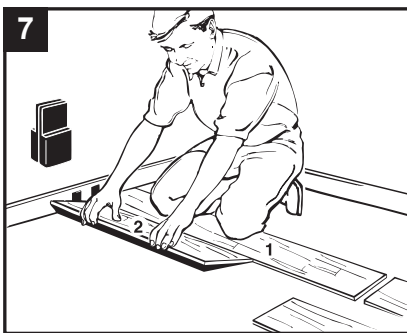
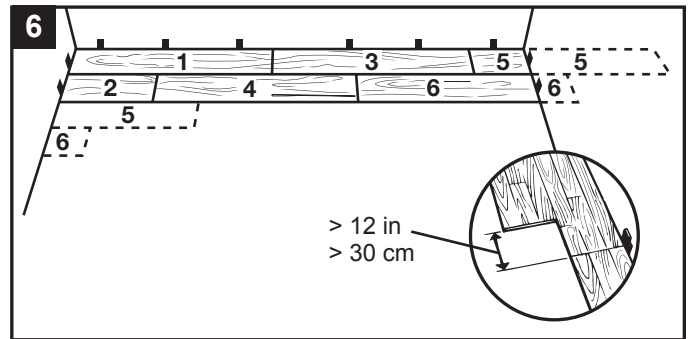
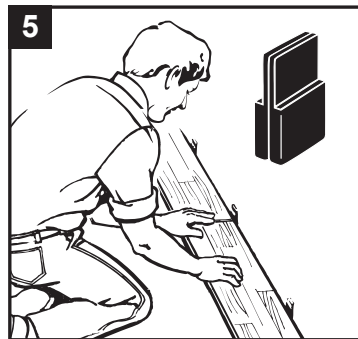
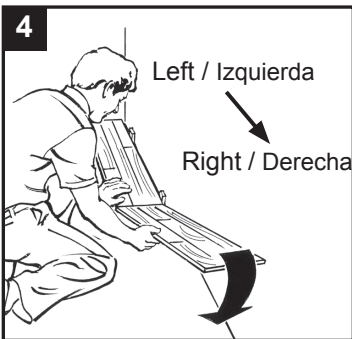
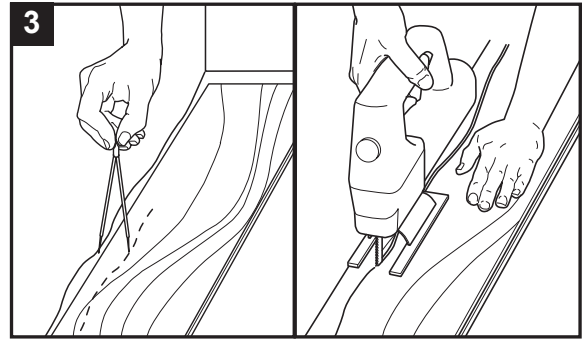
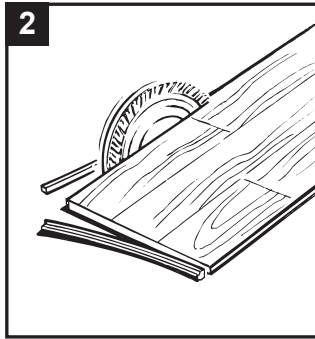
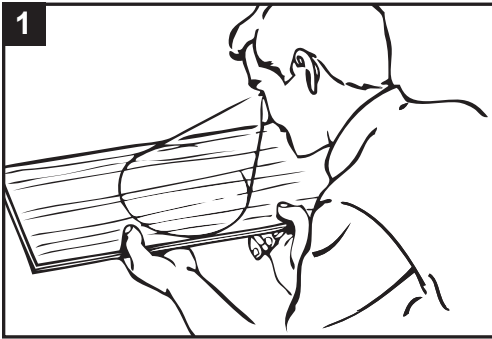

# PERGO XP Install Instructions

## Flooring Installation

1. Inspect each plank.
2. For the first row along straight walls, remove the tongue on all long side joints and on the short side of the 1st plank only.
3. For uneven walls, trace contour on tongue-side of plank and cut.
4. Assemble the first row tongue side toward wall. Insert the end tongue into the end groove and rotate downward to assemble. Keep the planks aligned and the joints closed.
5. Two spacers thick side to thick side =  $\frac{3}{8}$ ".
6. Provide a  $\frac{3}{8}$ " space for expansion on all sides. First piece must be at least 8" long. Start new rows with pieces trimmed from previous row. Ensure at least a 12" end joint offset.
7. At a slight angle, insert the tongue of plank 2 into the groove of plank 1 until the laminate edges meet, and then rotate down until the joints lock.
8. Join the short end of the plank first. There will be a gap on the long side joints when the plank is rotated down.
9. Raise the outside edge of the plank upward approximately 1". Maintain this angle as you push the plank in until the laminate edges meet. Rotate downward on the plank until the joint locks. Repeat these steps to complete the installation.

**Installation Tip: Place a carton of planks across the end of the row being installed to keep installed planks in place during installation.**

10. **Alternate Tap Method:** Align the tongues into the grooves of the long and short sides of the planks. Install the long side first by placing a tapping block no closer than 8" from either end and tap lightly along the long side until the joint is closed tightly. Then tap the end using the tapping block to into a locked position. **Note: Uneven tapping or use of excessive force may damage the joint.**
11. Ensure there will be a  $\frac{3}{8}$ " gap (after the joint is closed) to the wall for expansion.
12. For the last row, align the plank to be used on top of the 2nd to last row. Using a full width plank as a spacer, trace wall contour and cut plank.
13. For the last row, install the long side tongue into the groove with the end joint aligned. Using a pull bar and hammer, work evenly along the length of the plank and lightly tap the joint closed.
14. After tapping the long side joint closed, tap the short side closed, using a tapping block or a pull bar.

## Installation Under Doorway Frames

15. Slide plank under pre-cut door frame.
16. Tap the long side joint closed first. Then tap the end joint closed.

## Installation Around Fixed Objects (such as Pipes)

17. Allow  $\frac{3}{8}$ " expansion space around pipes or other fixed objects.

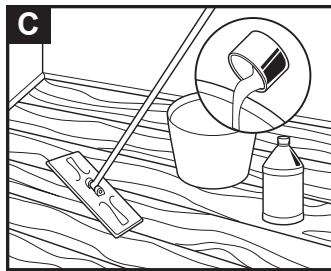
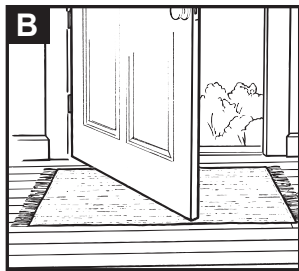

## Care and Cleaning

- A) Place felt floor protectors under legs of moveable furniture. Chair casters should be rubber – not plastic or metal.
- B) Place walk-off mats at entrances.
- C) **Dust mop or damp mop only. NO wet mopping.** Use 1 cup of vinegar per gallon of water OR  $\frac{1}{3}$  cup ammonia per gallon of water. Do not use abrasive cleaners, detergents, soaps, waxes or polishes. Use correct hard surface vacuum tools. **DO NOT** use rotating beater bars, floor scrubbers, steamers, jet mops or similar products. **DO NOT** allow liquids to stand on the floor. Wipe up spills immediately. **DO NOT allow moisture to be on the floor for longer than 30 minutes.**