

Submersible Waterfall Pump

3600 Gallons Per Hour

REMINDER
CALL 1-888-412-6001
BEFORE RETURNING TO STORE.



Questions, problems, missing parts? Before returning to your retailer, call our customer service department at 1-888-412-6001, 8 a.m.-6 p.m., EST, Monday-Friday, or email us at customer care@totalpond.com. Or visit our website www.totalpond.com.

PACKAGE CONTENTS

Part	Description	Quantity
A	Pump	1
B	1-1/2 in. and 2 in. ID tubing adapter	1
C	pump barrier bag	1

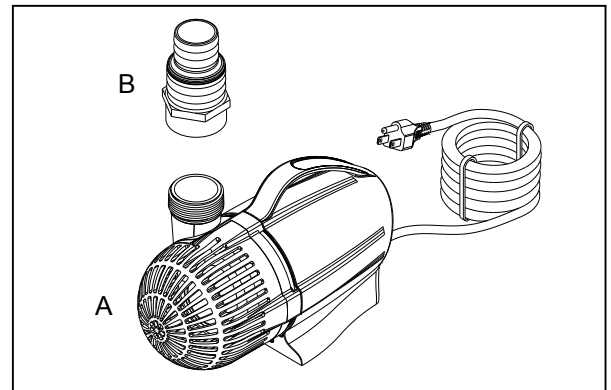
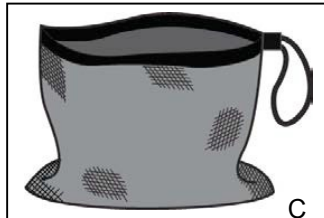

WARNINGS AND CAUTIONS

WARNING

- Risk of electrical shock. This pump is supplied with a grounding conductor and grounding-type attachment plug. To reduce the risk of electric shock, be certain that it is connected only to a properly grounded, grounding-type receptacle.
- Do not exceed the voltage shown on the pump.
- Always disconnect pump from the power source before beginning any maintenance or work on the pump.
- Inspect cord for damage before installation and/or maintenance. Replace the entire pump assembly if damage is found.
- Do not remove the grounding pin from the power cord plug.
- Risk of electrical shock: This pump has not been investigated for use in swimming pools or marine areas.

CAUTION

- This pump has been evaluated for use with water only.
- Use a proper power source as indicated on the pump label.
- Keep the cord away from high temperatures or other heat sources.
- Do not pump heated liquids.
- Do not let the pump run dry. Pump must be completely submerged for proper operation and cooling.
- Operate in fresh water only. Avoid heavily chlorinated water and water with high pH levels.
- Do not lift the pump by its power cord.

PREPARATION

Before beginning assembly or operation of product, make sure all parts are present. Compare parts with package contents list and diagram above. If any part is missing or damaged, do not attempt to assemble, install or operate the product. Contact customer service for replacement parts.

- Estimated Assembly Time: 5 minutes
- Tools required for assembly: hacksaw.

OPERATION INSTRUCTIONS

1. For maximum water flow, it is recommended that the largest tubing size for your pump is used. If using 1-1/2 in. ID tubing, proceed to step 2. If using 2 in. ID tubing, cut the adapter as shown using a hacksaw. Fig. 1

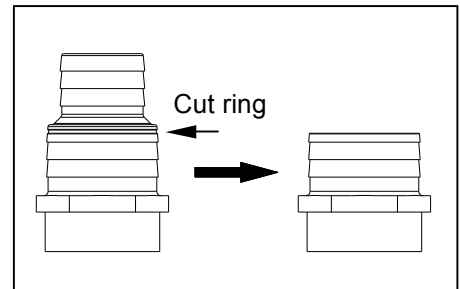

Fig. 1

2. Connect tubing to the outlet of the pump using an adapter. Fig. 2

NOTE: Tubing is NOT INCLUDED.

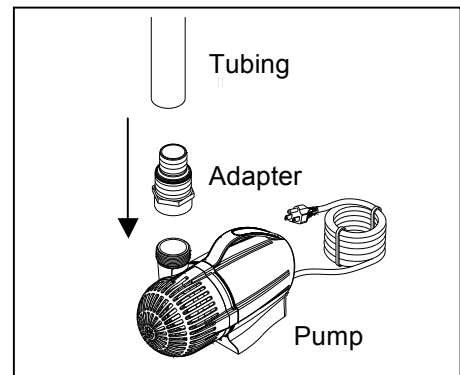

Fig. 2

3. Place the pump inside the pump barrier bag. Pull the drawstring until the pump barrier bag is fully closed around the tubing and power cord. Tie a knot in the drawstring. Fig. 3

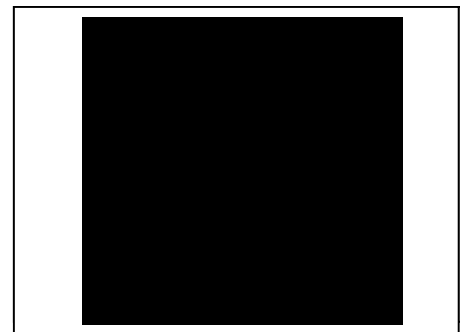

Fig. 3

4. Place the pump into the water and connect to a proper power source. Fig. 4

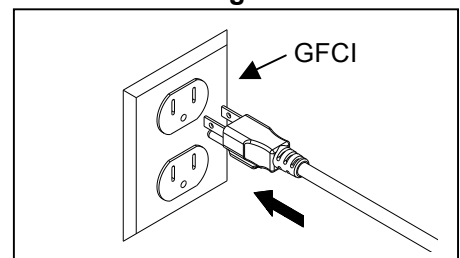

Fig. 4

CARE AND MAINTENANCE

- Clean the pump barrier bag and (if necessary the pump) regularly depending upon the environment in which it is operated. A drop in water flow is an indication that your pump barrier bag and/or pump require cleaning. The pump barrier bag not only protects your pump but significantly reduces the need for pump maintenance.
- Before cleaning, always disconnect the pump from the power source.
- Remove any large debris from pump barrier bag. Use a garden hose to rinse off any other dirt from the pump barrier bag.
- Remove all parts from the pump and clean in warm, soapy water.
- Disassemble the screen and remove the impeller housing to expose the impeller assembly. Remove the impeller assembly by pulling on the back round plate behind the impeller.

NOTE: This pump uses a very strong magnet to achieve superior performance. When removing the impeller assembly there will be considerable magnetic force resisting the extraction of the impeller assembly. This is normal. Likewise when replacing the impeller assembly there will be a strong magnetic force pulling the assembly into the pump to potentially cause injury to fingers and in rare cases damaging the ceramic shaft or rear bearing. Use thick gloves when replacing the impeller assembly.

- Use a soft cloth or brush to clean the impeller assembly and the inside of the impeller housing. Refer to the diagram in the replacement parts list.

TROUBLESHOOTING

If the pump fails to operate:

- Check to make sure the power cord is plugged in and the pump is getting power.
- Check the pump outlet and any tubing, spitters, etc., for kinks or obstructions.
- Remove the inlet screen and/or pump cover, and impeller housing to expose the impeller. Turn the impeller to ensure that it is not broken or jammed. Also check to make sure that the ceramic shaft or bearings are not broken.

If the performance of the pump is not satisfactory or the pump does not flow evenly:

- Check to make sure the pump is completely submerged in water.
- Check to make sure the impeller and the housing are clean.
- Check to make sure the pump barrier bag is clean.

REPLACEMENT PARTS LIST

For replacement parts, call our customer service department at 1-888-412-6001, 8 a.m.-6 p.m., EST, Monday-Friday.

Part	Description
B	1-1/2 in. and 2 in. ID tubing adapter
C	pump barrier bag
D	Screen
E	Impeller housing
F	Impeller Assembly
G	O-ring

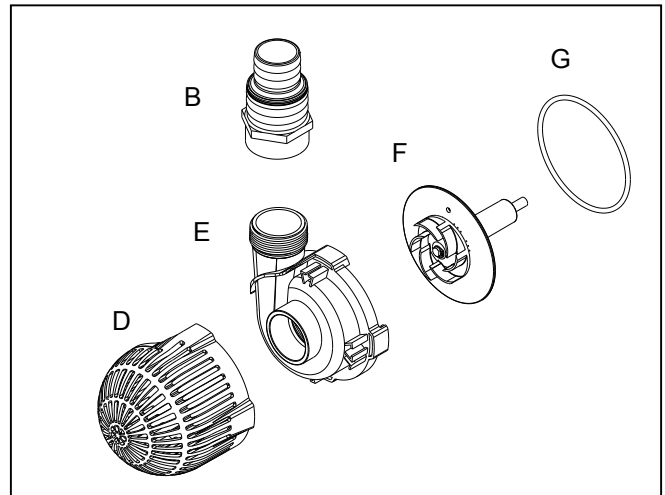
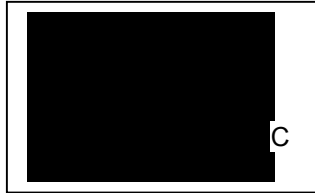

PUMP PERFORMANCE

Flow Rates (GPH)					
LIFT (feet)	18			230	1,680
	17			460	1,960
	16		220	670	2,260
	15		420	880	2,550
	14		590	1,090	2,770
	13	210	780	1,320	3,020
	12	350	950	1,550	3,230
	11	470	1,080	1,780	3,410
	10	581	1,215	2,009	3,580
	9	655	1,310	2,240	3,720
	8	696	1,426	2,490	3,870
	7	792	1,532	2,660	4,020
	6	887	1,664	2,850	4,150
	5	940	1,770	3,050	4,320
	4	1,077	1,849	3,197	4,480
	3	1,120	1,940	3,348	4,660
	2	1,301	2,034	3,440	4,830
1	1,374	2,134	3,560	5,000	
0	1,450	2,250	3,700	5,150	
	LL1200	LL2000-A	LL3600-A	LL5100	
	Waterfall Pumps				

LIMITED WARRANTY

All pumps and electrical products are warranted to the user against defective material and workmanship, under normal working conditions. This warranty period begins on the date of purchase by the original purchaser.

TotalPond® pond and waterfall pumps are warranted to the user against defective material and workmanship, under normal working conditions for 2 years from the date of purchase. All other TotalPond® electrical products are warranted to the user against defective material and workmanship, under normal working conditions for 1 year from the date of purchase. All TotalPond® liners are warranted to the user against defective workmanship, under normal working conditions for 20 years from the date of purchase. All other TotalPond® product is warranted to the user against defective material and workmanship, under normal working conditions for 90 days.

Application

Warranty covers only properly installed and maintained units. Pump warranty is limited to applications pumping fresh water in a pond or fountain only. Other liquid applications or extreme temperature uses must be approved in writing by the manufacturer. Receipt and product date code are required for warranty claims.

Warranty Claim

Warranty claims must be made by calling customer service (at 1-888-412-6001). If the item is determined to be defective, you will be given authorization to return the defective part(s), freight pre-paid, along with proof of purchase.

Disposition

The manufacturer will make a good faith effort for prompt disposition regarding all warranty claims. Returned product will be inspected to determine cause of failure before warranty is applied. Warranty does not cover any costs associated with the shipping, handling, installation or removal of products or parts subject to this warranty. For products damaged in transit, a claim should be filed with the carrier.

Disclaimer

Any oral statements made about the product by the seller, the manufacturer, the representatives, or any other parties do not constitute warranties, should not be relied upon by the user, and are not part of the contract for sale. The seller's and manufacturer's only obligation, and buyer's only remedy shall be for the manufacturer to either replace and/or repair at the manufacturer's sole discretion, the product as described above. Neither seller nor the manufacturer shall be liable for injury, loss or damages for lost profits, lost sales, injury to person or property, or any other incidental or consequential loss arising from any cause whatsoever, no matter whether based upon warranty, contract, negligence or other misuse, and the buyer and user agree that no other remedy shall be available to them. Before using, the buyer and user shall determine the suitability of the product for the intended use, and assume all risk and liability whatsoever in connection therewith. The warranty and remedy described in this limited warranty is an exclusive warranty and remedy in lieu of any other warranty or remedy expressed or implied. All other warranties and remedies are hereby expressly excluded, including but not limited to any implied warranty of merchantability of fitness for any particular purpose. This warranty gives the buyer and user specific legal rights, and buyer and user may also have other rights which vary from state to state. Some states do not allow exclusions or limitations of incidental or consequential damages, so the above limitations or exclusions may not apply to you.

REMINDER

CALL 1-888-412-6001

BEFORE RETURNING TO STORE