

1617-48

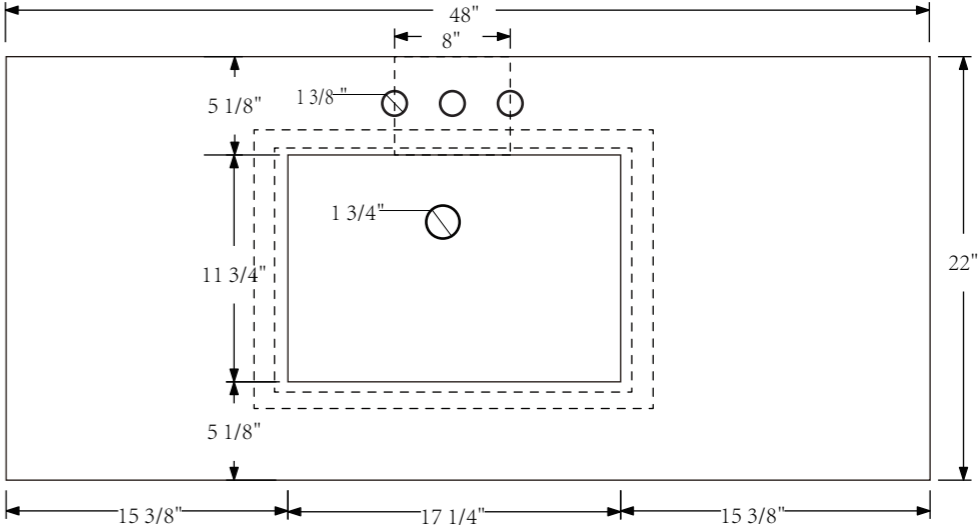

TOP VIEW

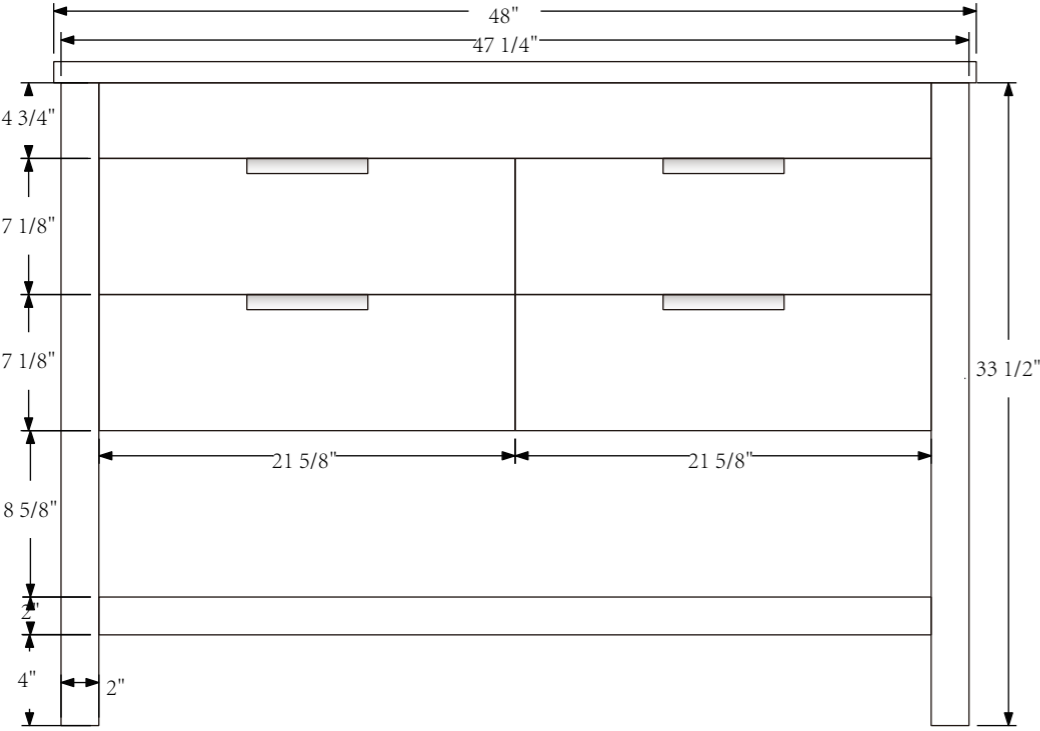

FRONT VIEW

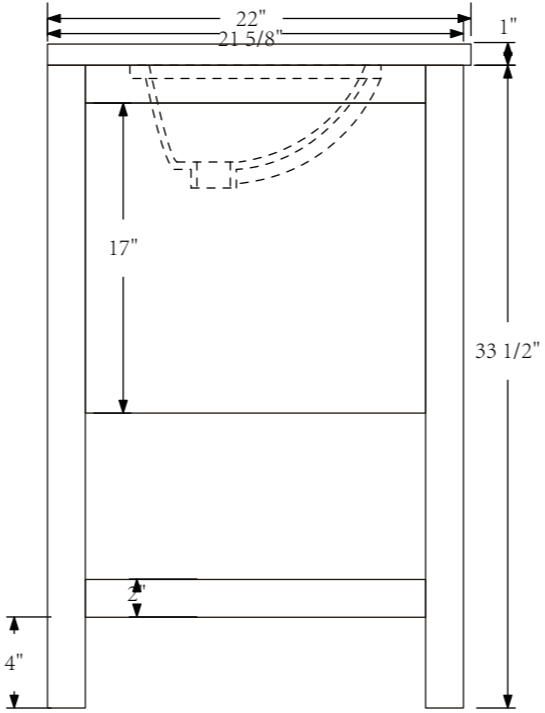

SIDE VIEW

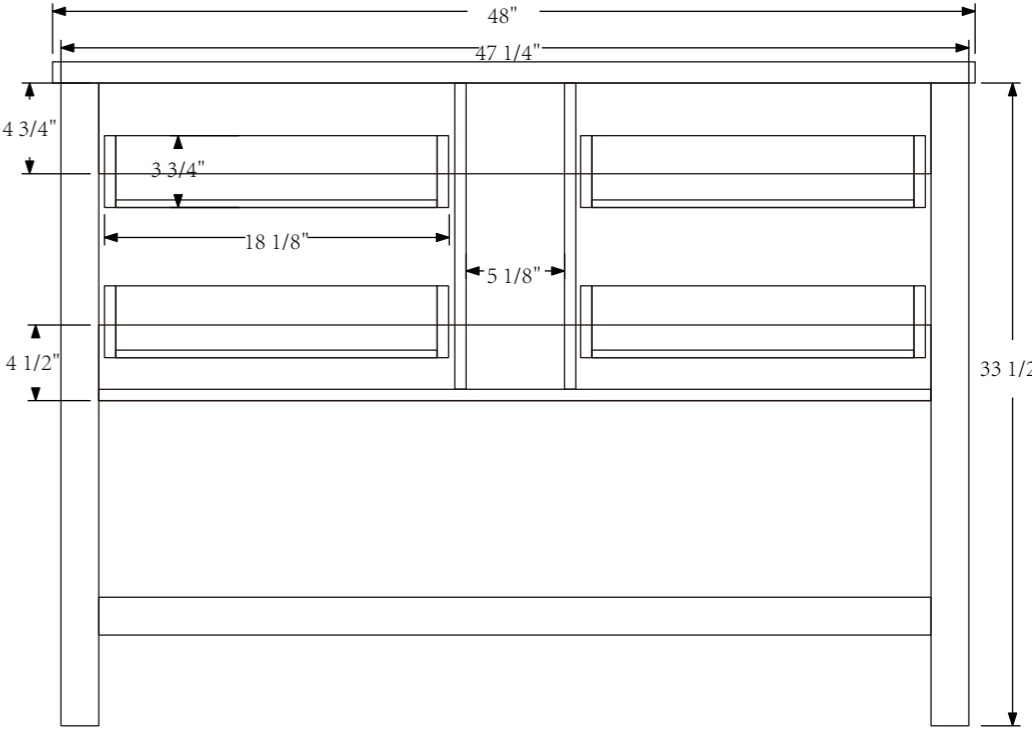

BACK VIEW