



Made with 50% recycled resin
Fait de 50 % de résine recyclée
Hecho en un 50% con resina reciclada



Owner's Manual
Manuel du propriétaire
Manual del usuario

Wall or Base Cabinet
Armoire murale ou Armoire de base
Armario de pared o piso



Call Us First - Do Not Return to the Store
For assistance with assembly, parts or for additional product information, call our toll - free number: 1-877-638-7056 Opt. 1
hdpcs@keter.com

Appelez-nous d'abord – Ne retournez pas au magasin
Si vous avez besoin d'aide avec l'assemblage, les pièces ou pour obtenir davantage d'information sur le produit, composez notre numéro sans frais : 1-877-638-7056 Poste 1
hdpcs@keter.com







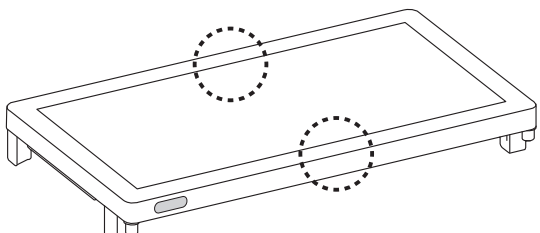
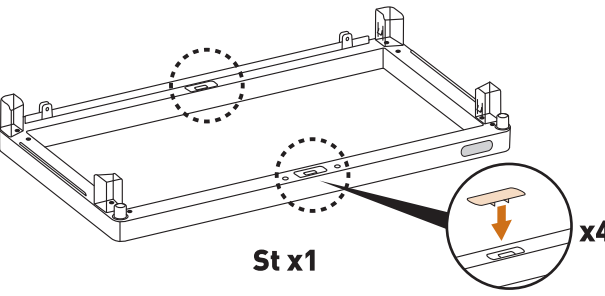
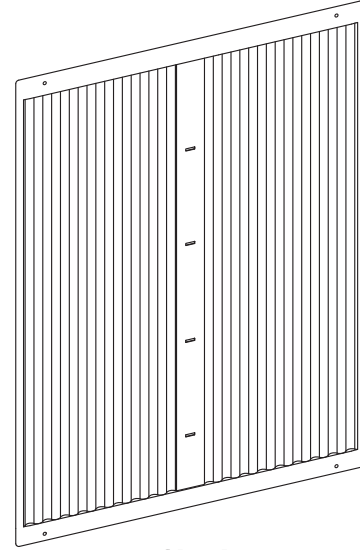
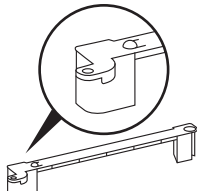
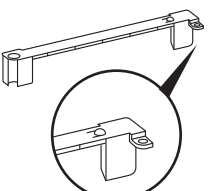
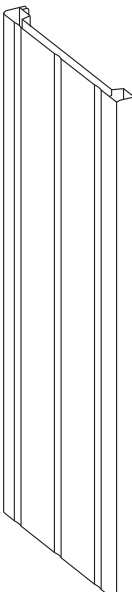
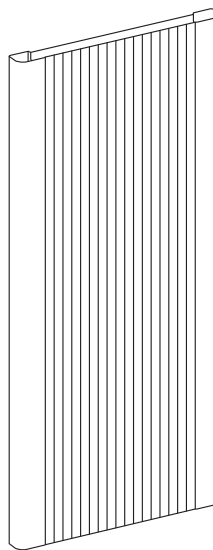
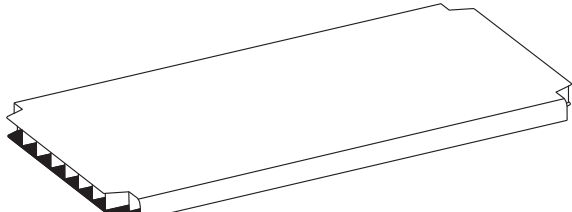

Primero llámenos, no regrese a la tienda
Para recibir ayuda con el ensamblaje, las piezas o información adicional sobre el producto, llame a nuestro número gratuito: 1-877-638-7056 Opt. 1
hdpcs@keter.com

Tools and other products shown (except as specified) are for illustration purposes only and are not included with the Wall & Base Cabinet.

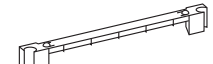
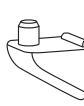
Les outils ainsi que les autres produits illustrés (sauf indication contraire) sont pour les besoins de l'illustration uniquement et ne sont pas inclus avec l'armoire murale et sur plancher.

Las herramientas y otros productos se exhiben sólo con fines ilustrativos y no están incluidos en el armario de pared y piso (excepto que se especifique).

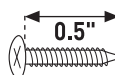
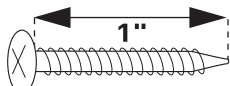
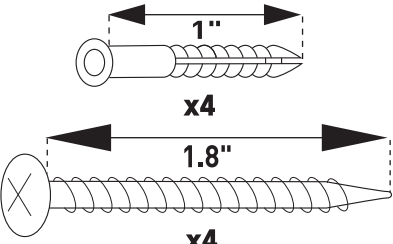
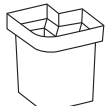
Assembly parts • Pièces d'assemblage • Piezas de ensamblaje

| | | | |
|--|---|---|--|
|  <p>St x1</p>  <p>St x1 x4</p> |  <p>Sb x1</p> |  <p>SDR x1</p>  <p>SDL x1</p> | |
|  <p>Sp x2</p> |  <p>SD x2</p> |  <p>SF x2</p> |  <p>x8</p> |
| | |  <p>SHN x2</p> |  <p>x10</p> |
| | |  <p>x12</p> |  <ul style="list-style-type: none"> • For option B only. • Pour l'option B seulement. • Para la opción B únicamente. |
|  <ul style="list-style-type: none"> • For option B only. • Pour l'option B seulement. • Para la opción B únicamente.  <p>x8</p>  <p>x4</p>  <p>x4</p> | |  <p>x4</p> |  <p>SBH x2</p>  <p>SBC x2</p> |

OPTION A

- To place on floor.
- Pour une installation au sol.
- Para colocar sobre el piso.

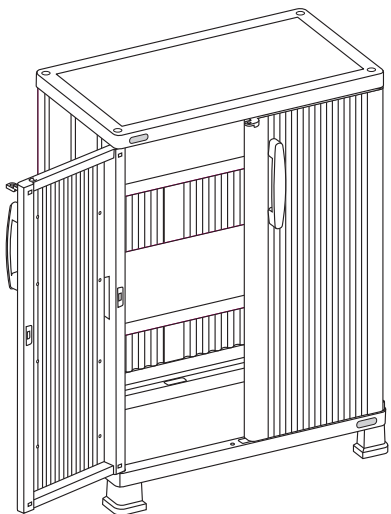

OPTION B

- To mount on wall.
- Installation murale.
- Para montar sobre la pared.

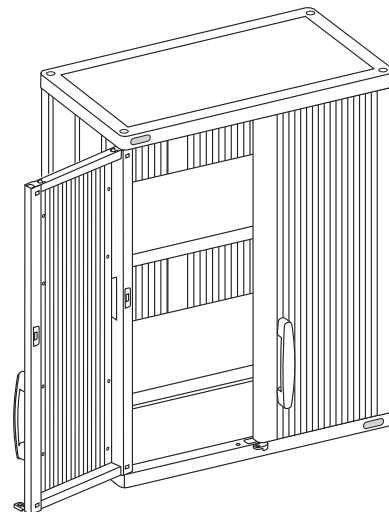

OPTION A

- To place on floor.
- Pour une installation au sol.
- Para colocar sobre el piso.

- Use the **St** panel with no logo.
- Utiliser le panneau **St** sans logo.
- Use el panel **St** sin logo.

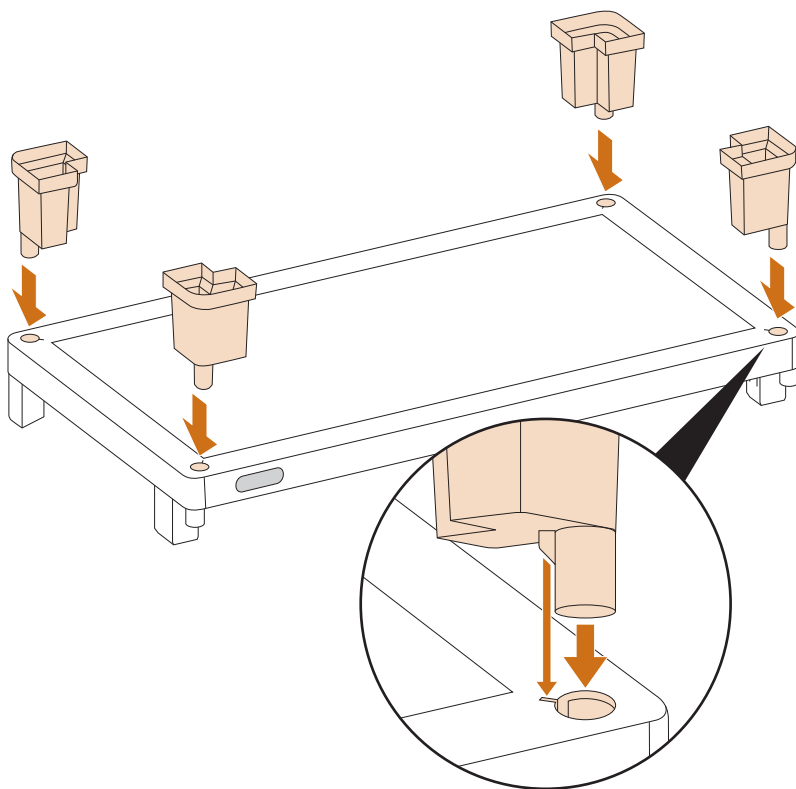

4x

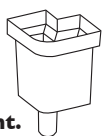

- For option A only.
- Pour l'option A seulement.
- Para la opción A únicamente.

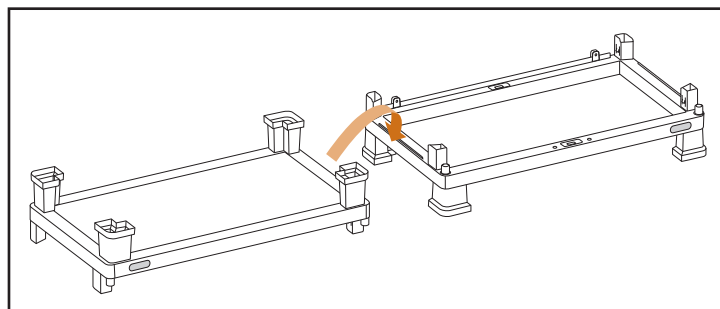

4x

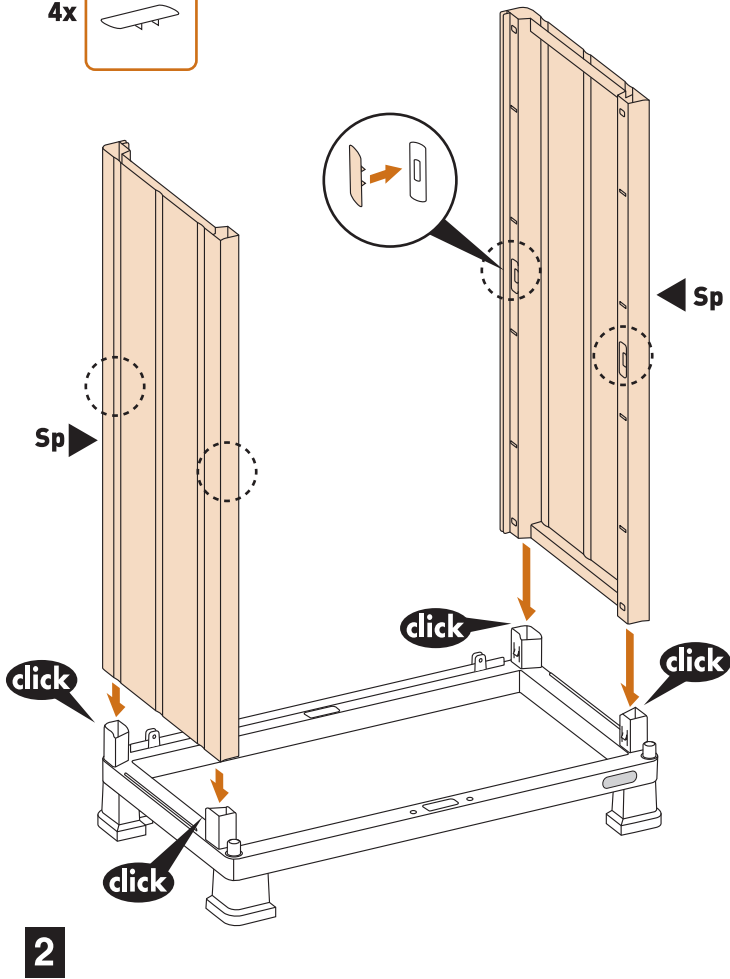

2

- Please ensure that part **Sb** is properly inserted into the track of part **St**.
- S'assurer que la partie **Sb** est bien insérée dans la rainure de la pièce **St**.
- Asegúrese que la pieza **Sb** esté insertada correctamente en la ranura de la pieza **St**.

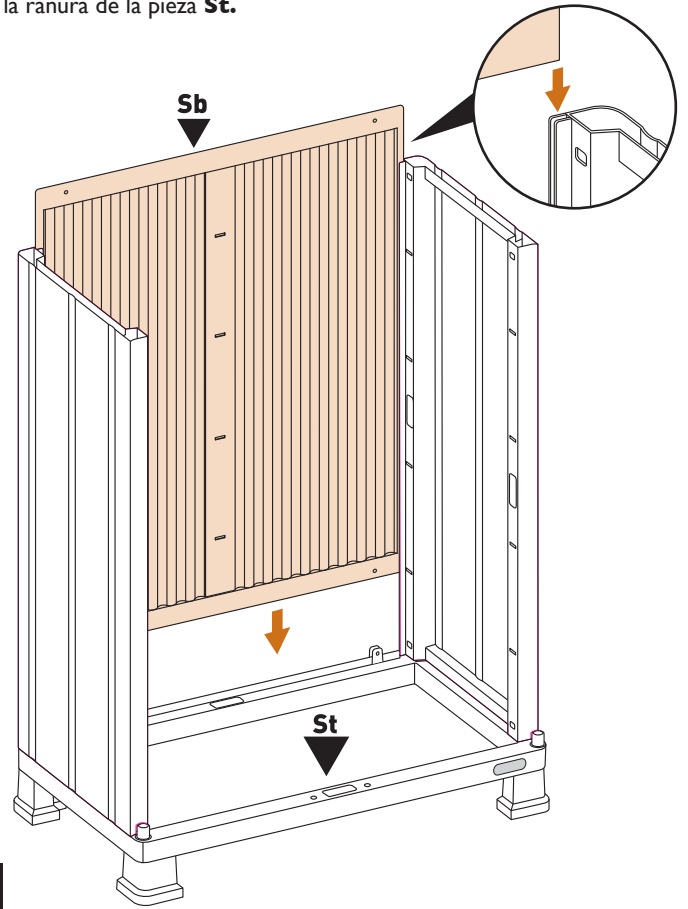

3

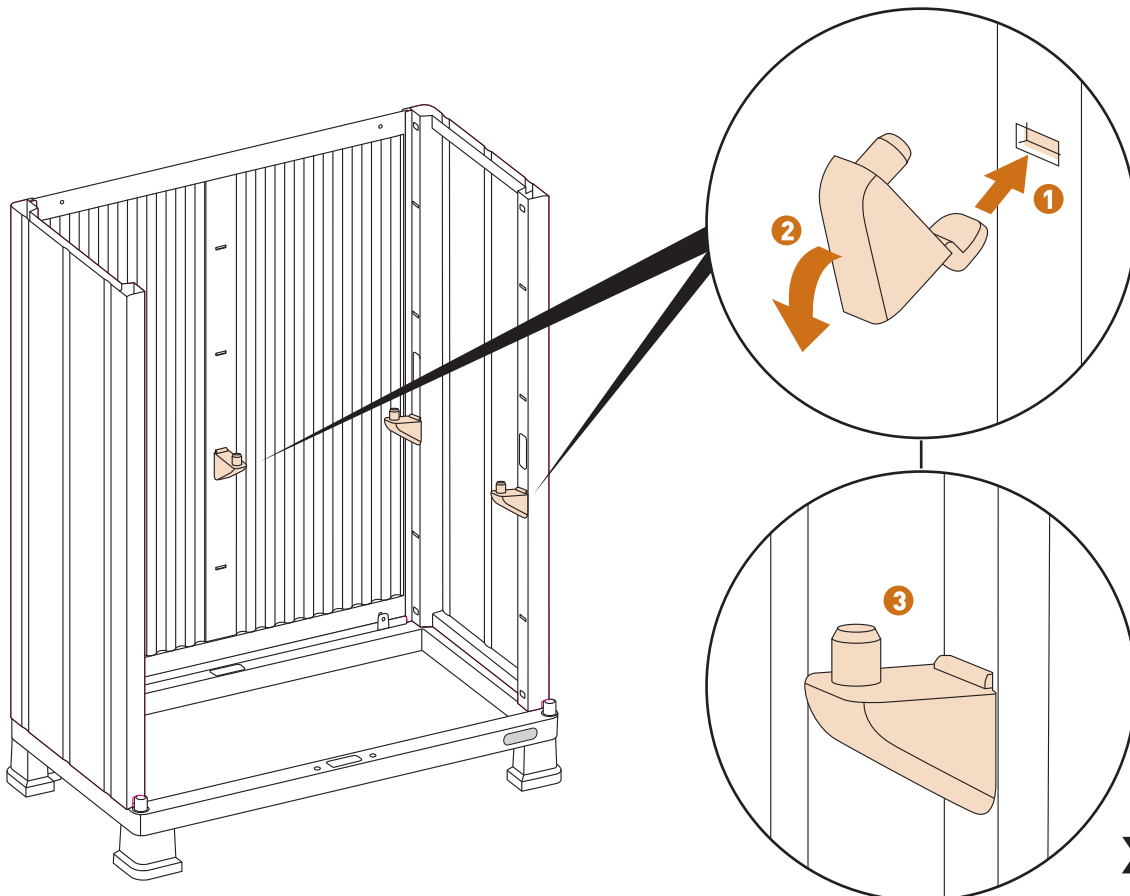

4

x5

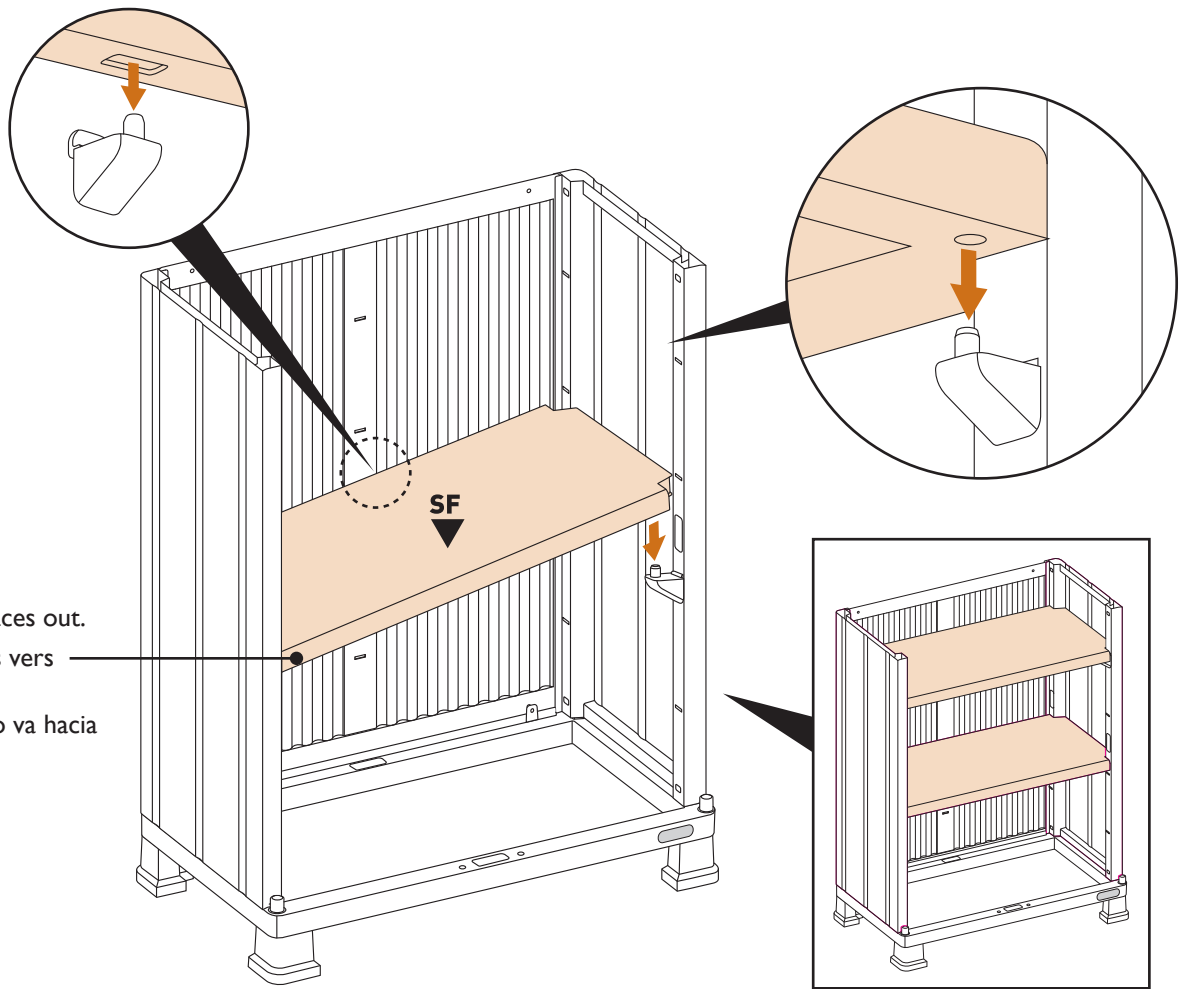

- The rounded edge faces out.
- Les rebords arrondis vers l'extérieur.
- El borde redondeado va hacia afuera.

5

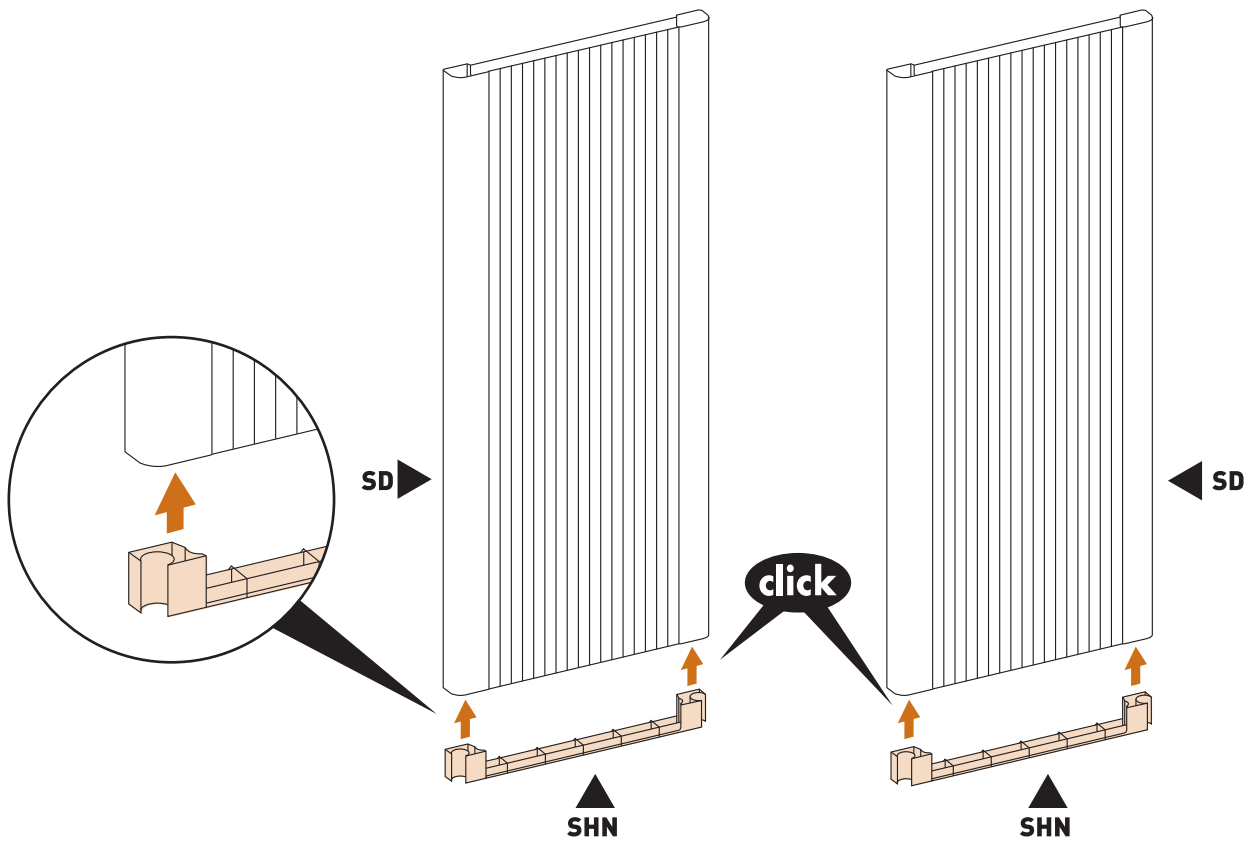

6

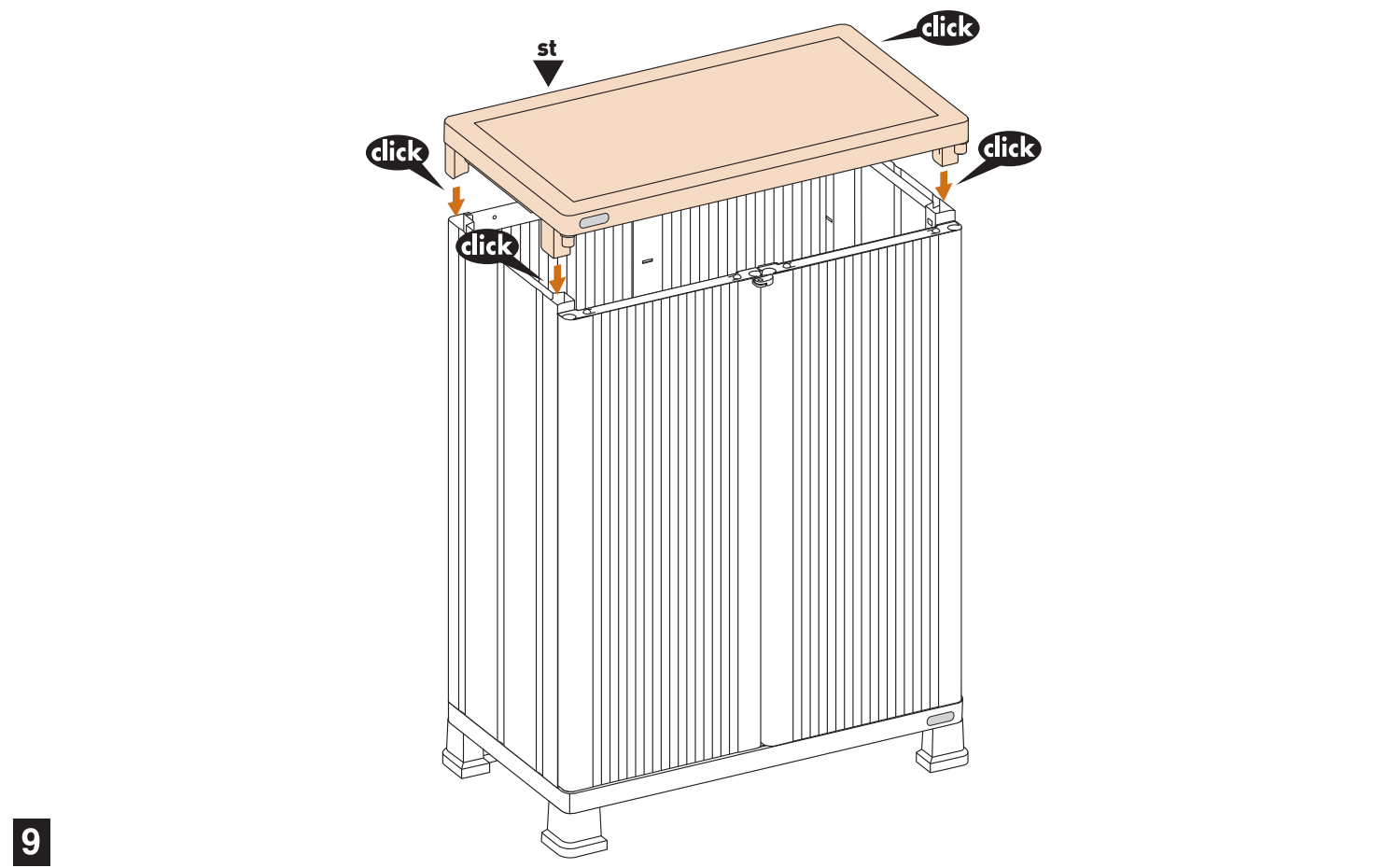
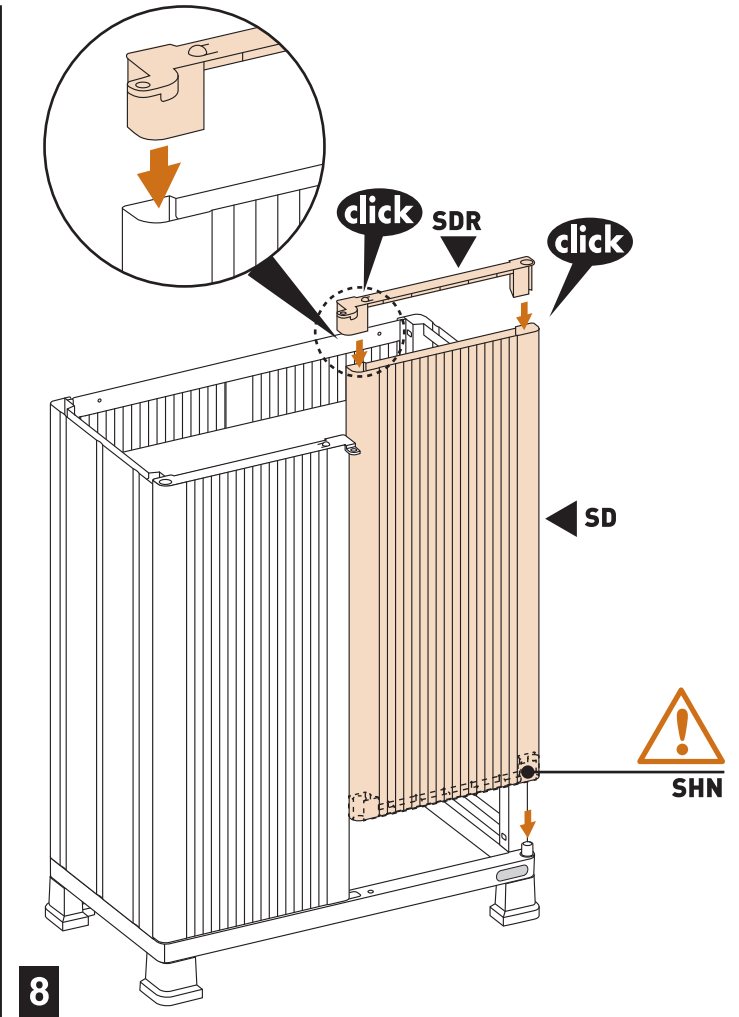
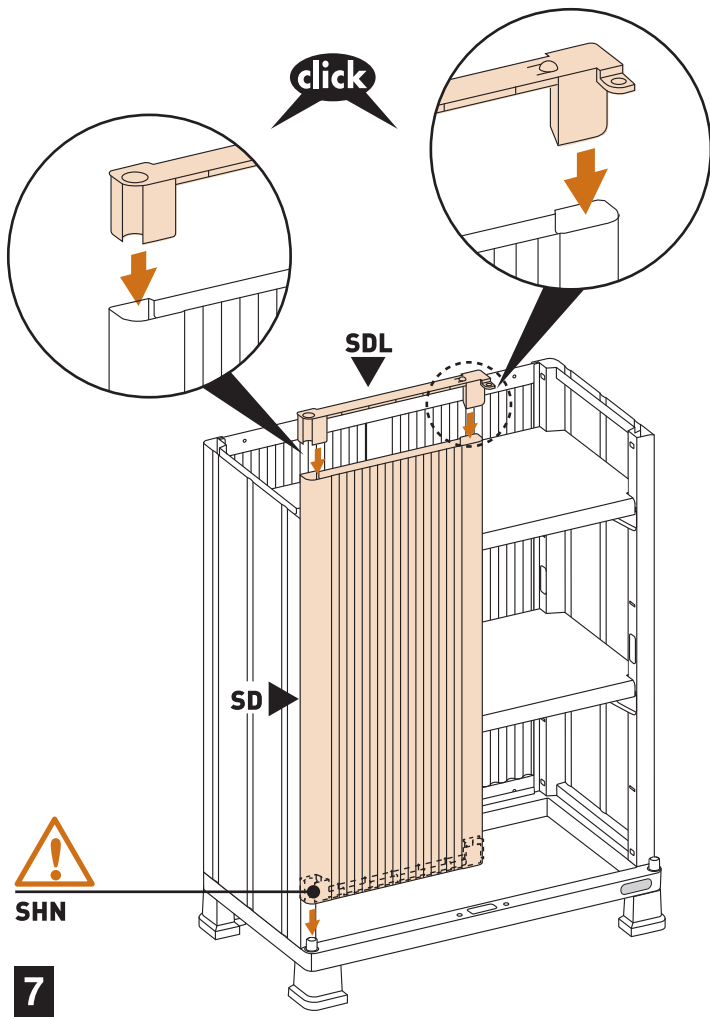



- **ASSEMBLY TIP:** Insert screws through door panels using the guide holes before attaching handles.
- **ASTUCE D'ASSEMBLAGE :** Insérer les vis dans les panneaux de porte par les trous guide avant de fixer les poignées.
- **CONSEJO DE ENSAMBLAJE:** Inserte los tornillos a través de los paneles de la puerta usando los orificios guía antes de sujetar las manijas.

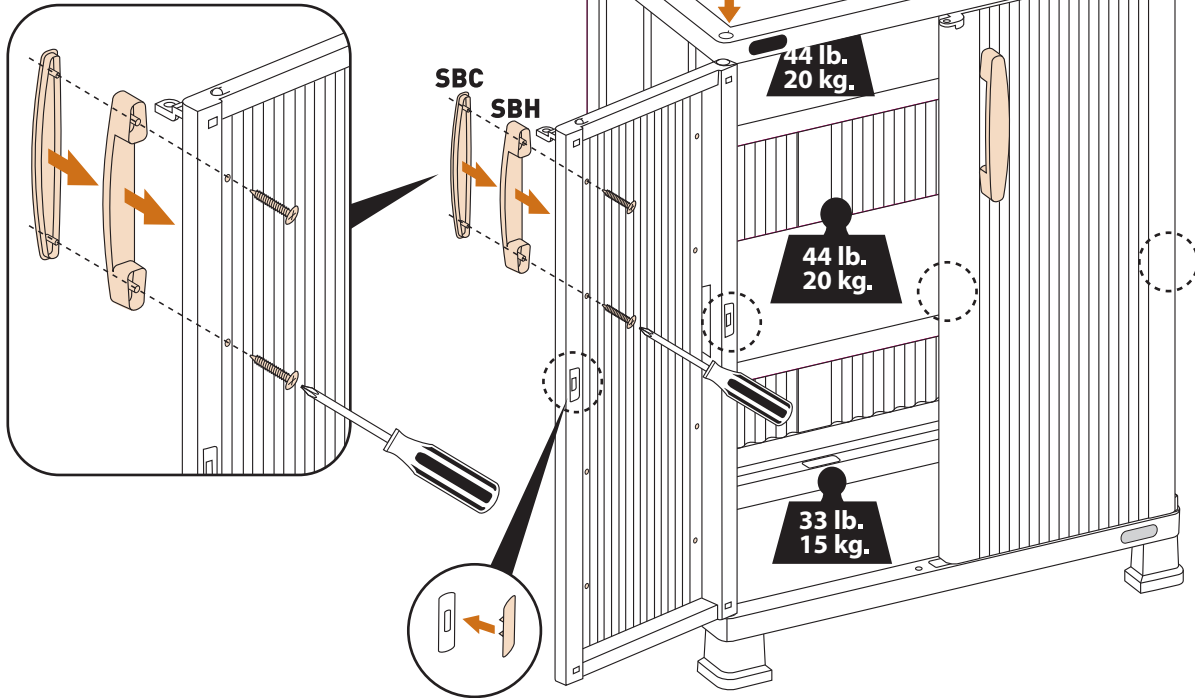

10

OPTION B

- To mount on wall.
- Installation murale.
- Para montar sobre la pared.

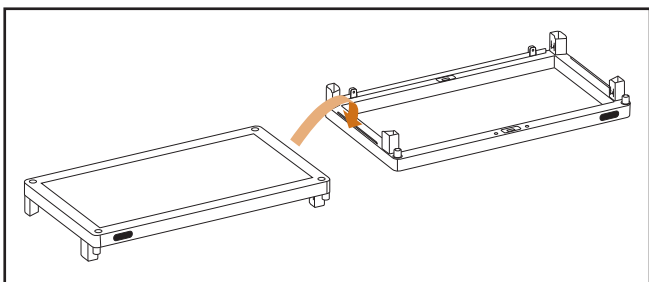
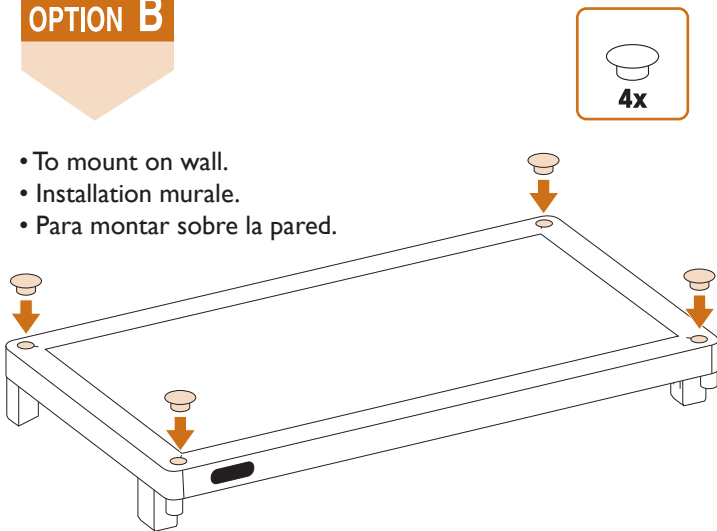

1

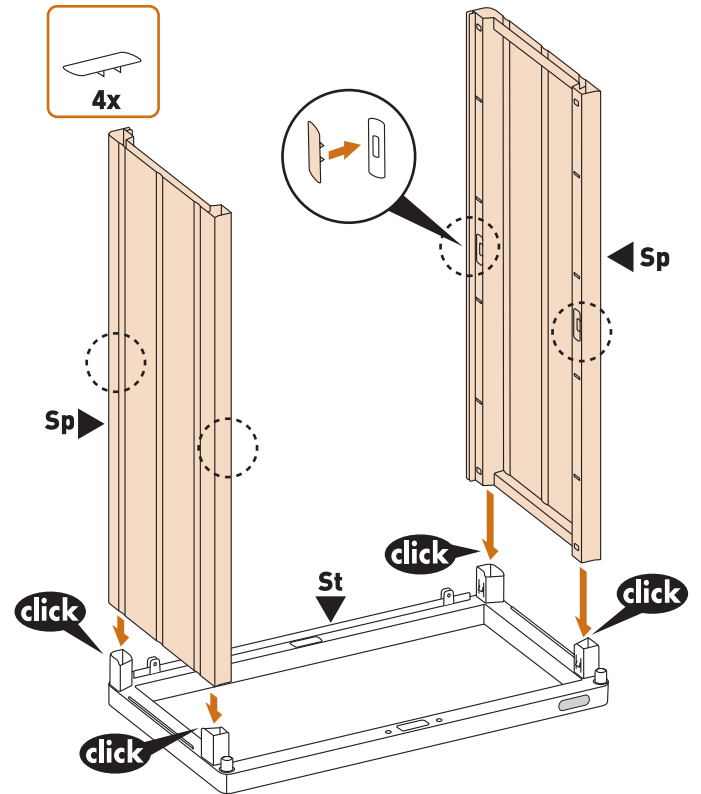

2

- Please ensure that part **Sb** is properly inserted into the track of part **St**.
- S'assurer que la partie **Sb** est bien insérée dans la rainure de la pièce **St**.
- Asegúrese que la pieza **Sb** esté insertada correctamente en la ranura de la pieza **St**.

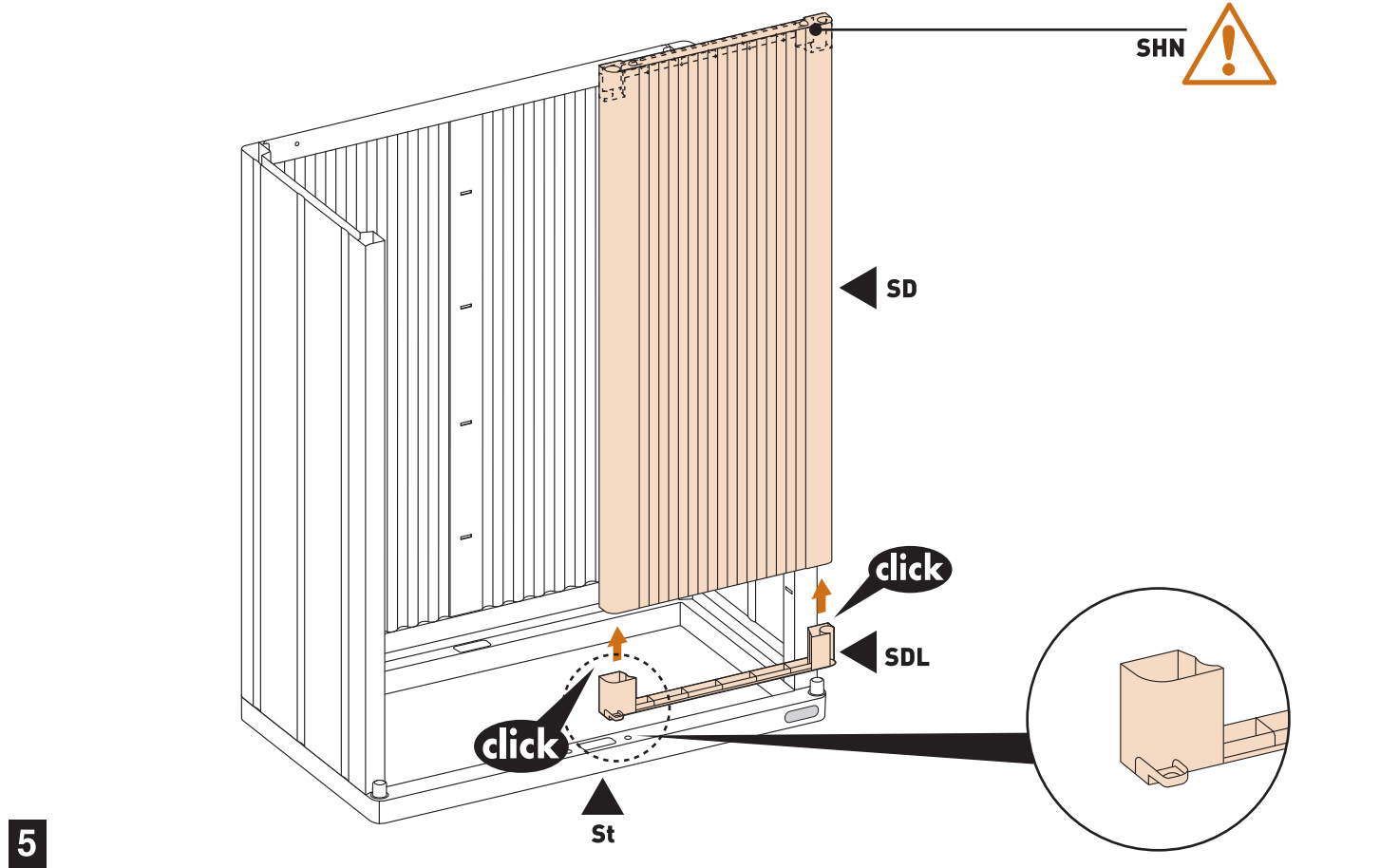
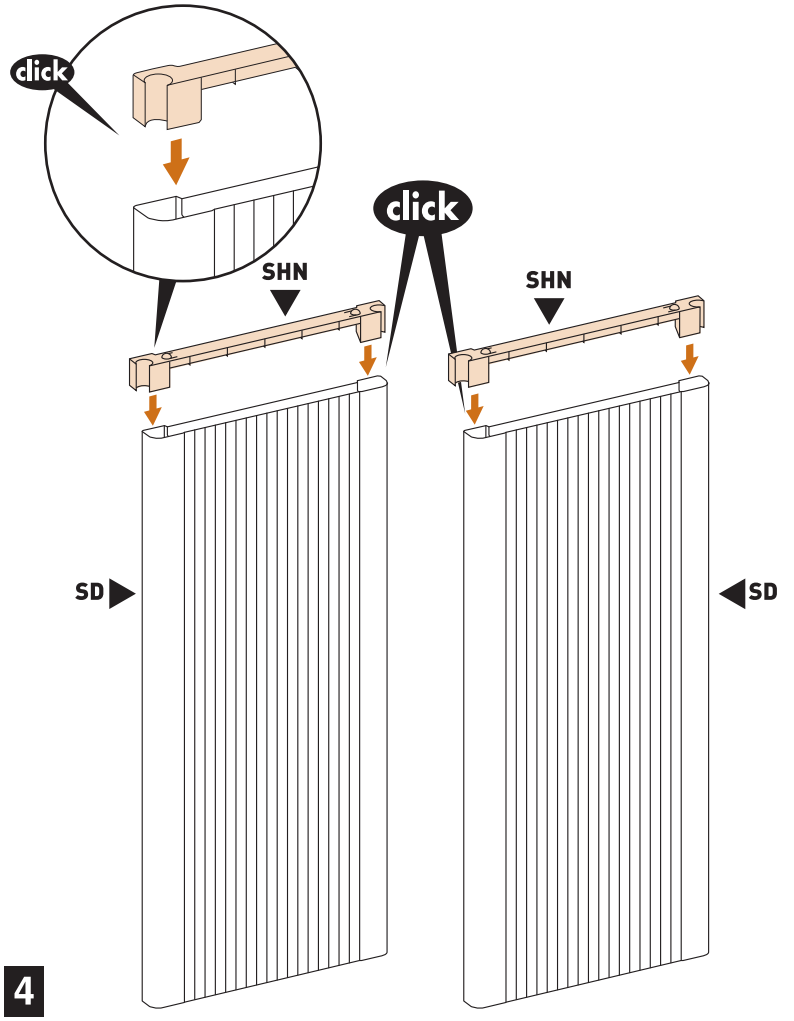
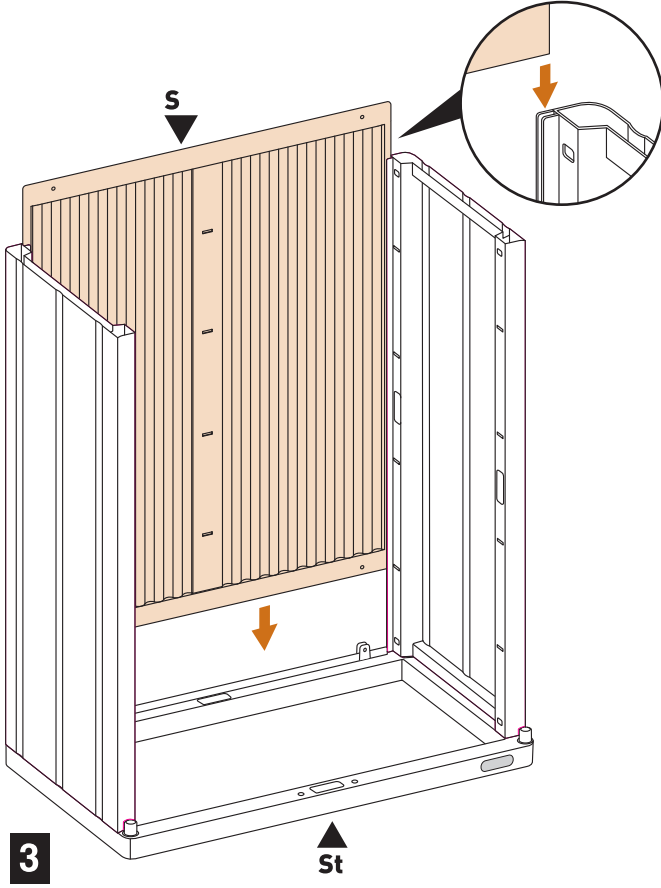



SHN

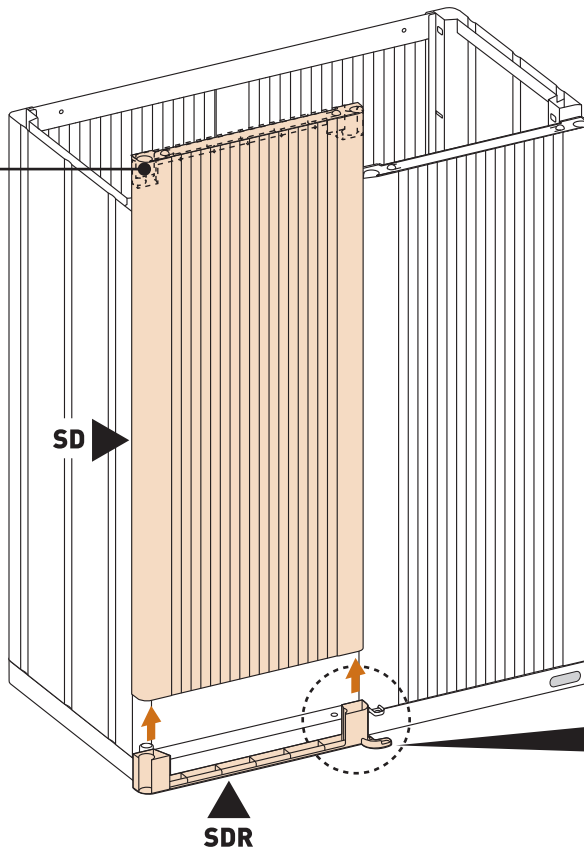

6

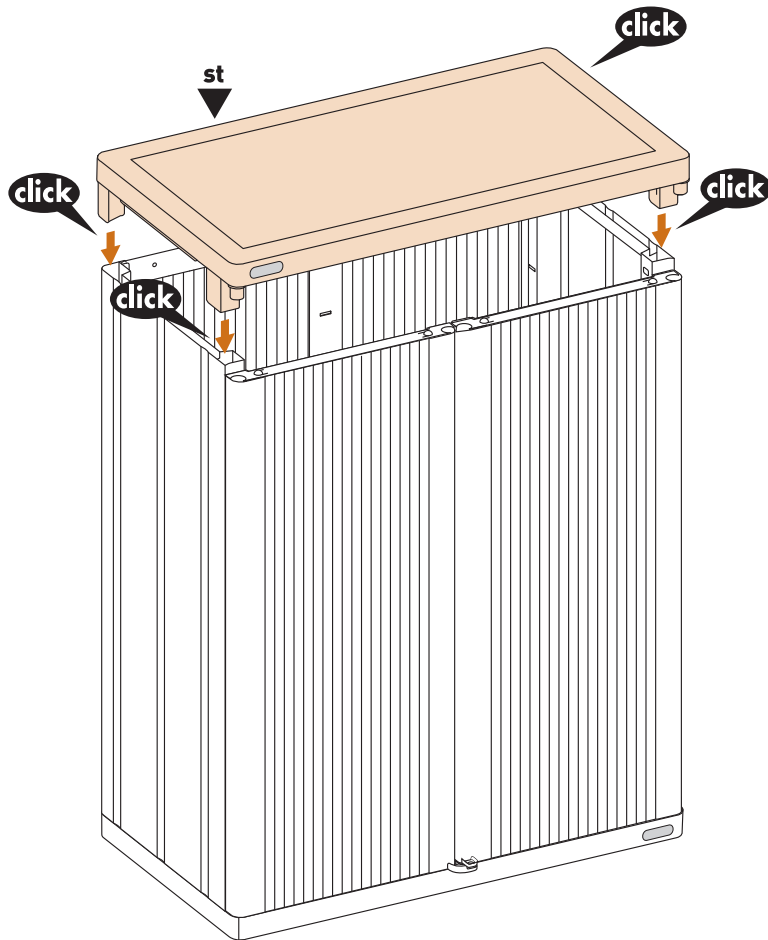

7



- Please insure that all screws are inserted into the 8 marked places.
- S'assurer que toutes les vis sont insérées dans les 8 endroits indiqués.
- Asegúrese de que todos los tornillos estén insertados en los 8 lugares marcados.

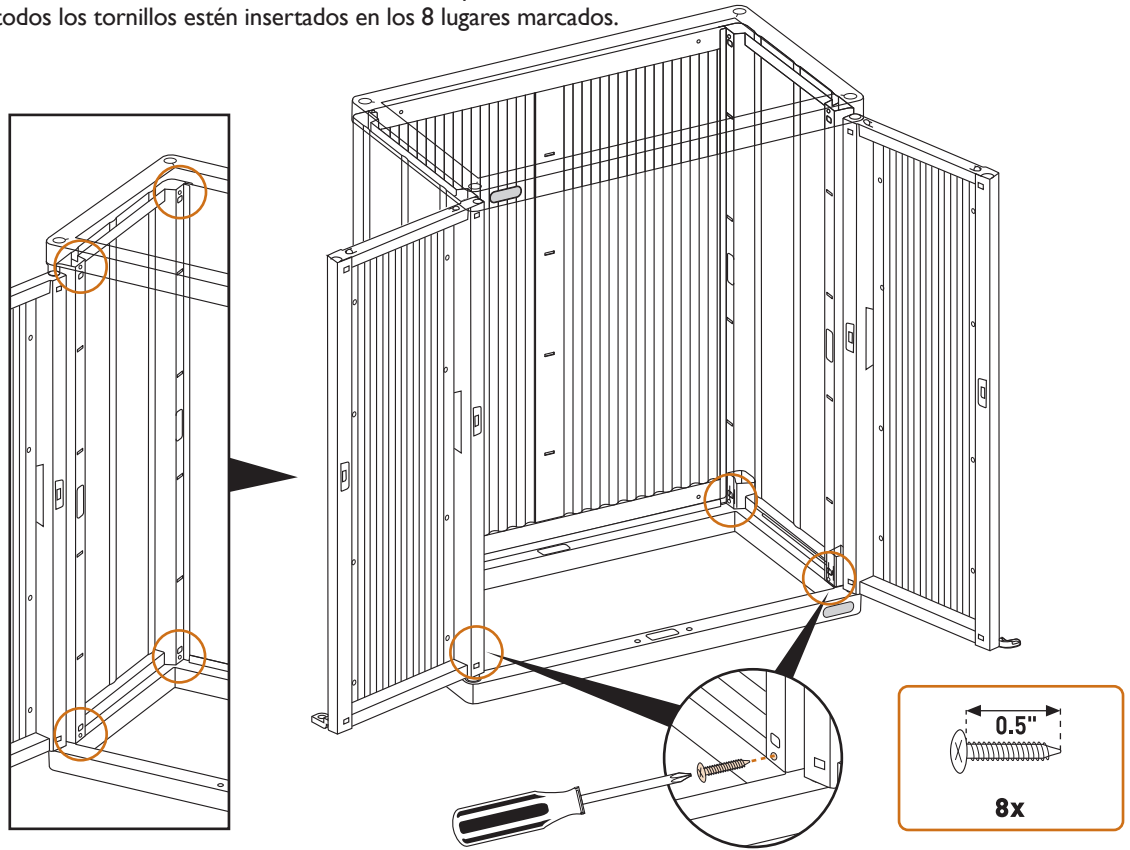

8



- **ASSEMBLY TIP:** Insert screws through door panels using the guide holes before attaching handles.
- **ASTUCE D'ASSEMBLAGE :** Insérer les vis dans les panneaux de porte par les trous guide avant de fixer les poignées.
- **CONSEJO DE ENSAMBLAJE:** Inserte los tornillos a través de los paneles de la puerta usando los orificios guía antes de sujetar las manijas.

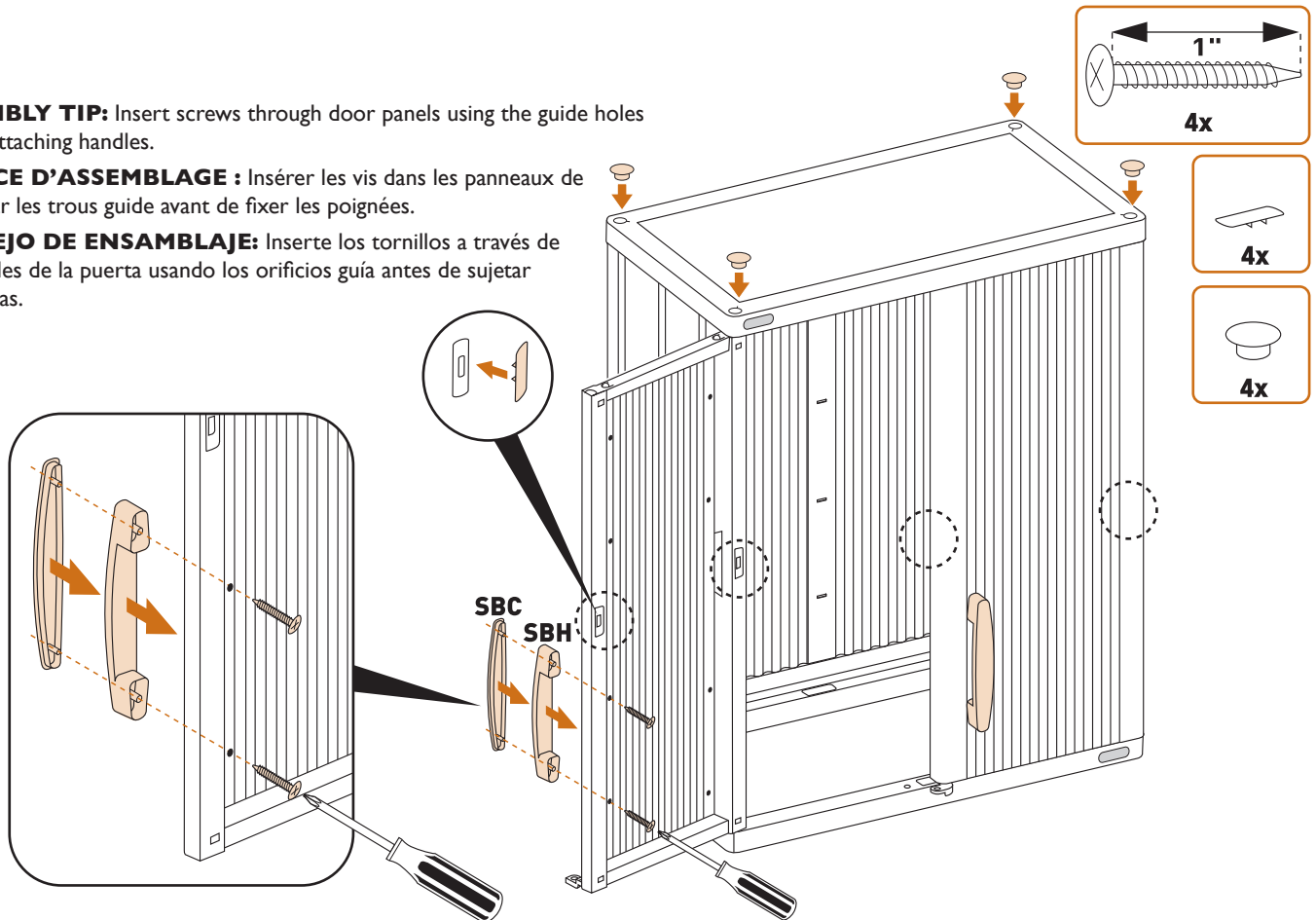

9



• **ASSEMBLY TIP:** Please use a level when mounting the cabinet to the wall.

• **ASTUCE D'ASSEMBLAGE :** Veuillez vous servir d'un niveau pour l'installation de l'armoire au mur.

• **CONSEJO DE ENSAMBLAJE:** Use un nivel al montar el armario sobre la pared.

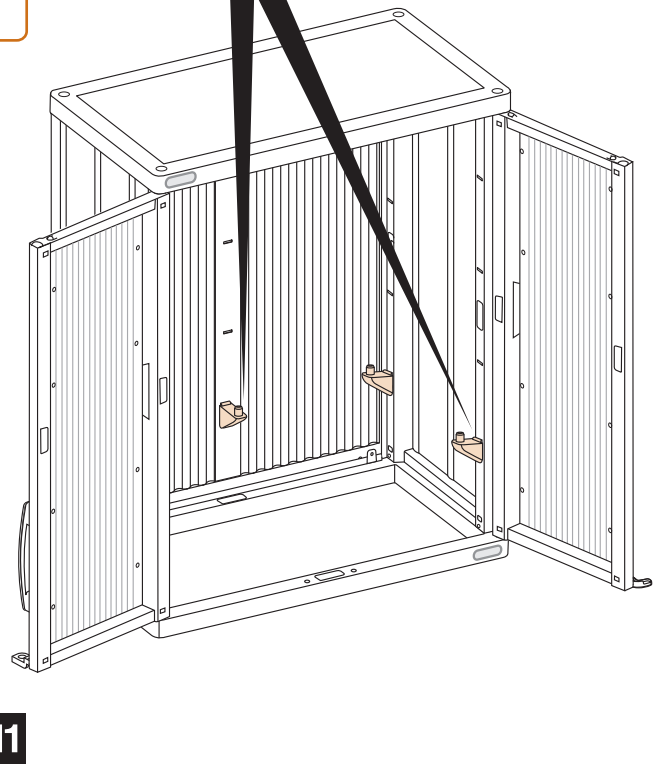
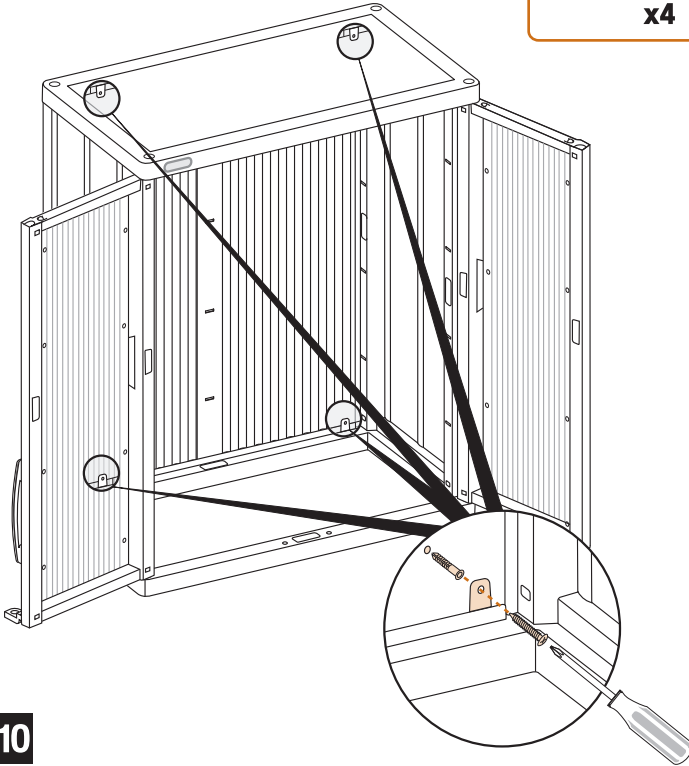
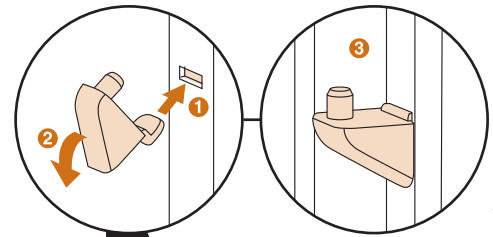
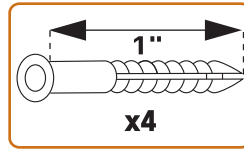
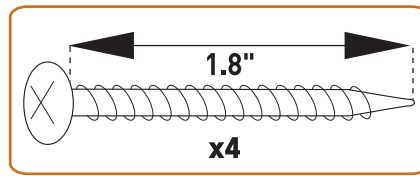

• The rounded edge faces out.

• Les rebords arrondis vers l'extérieur.

• El borde redondeado va hacia afuera.

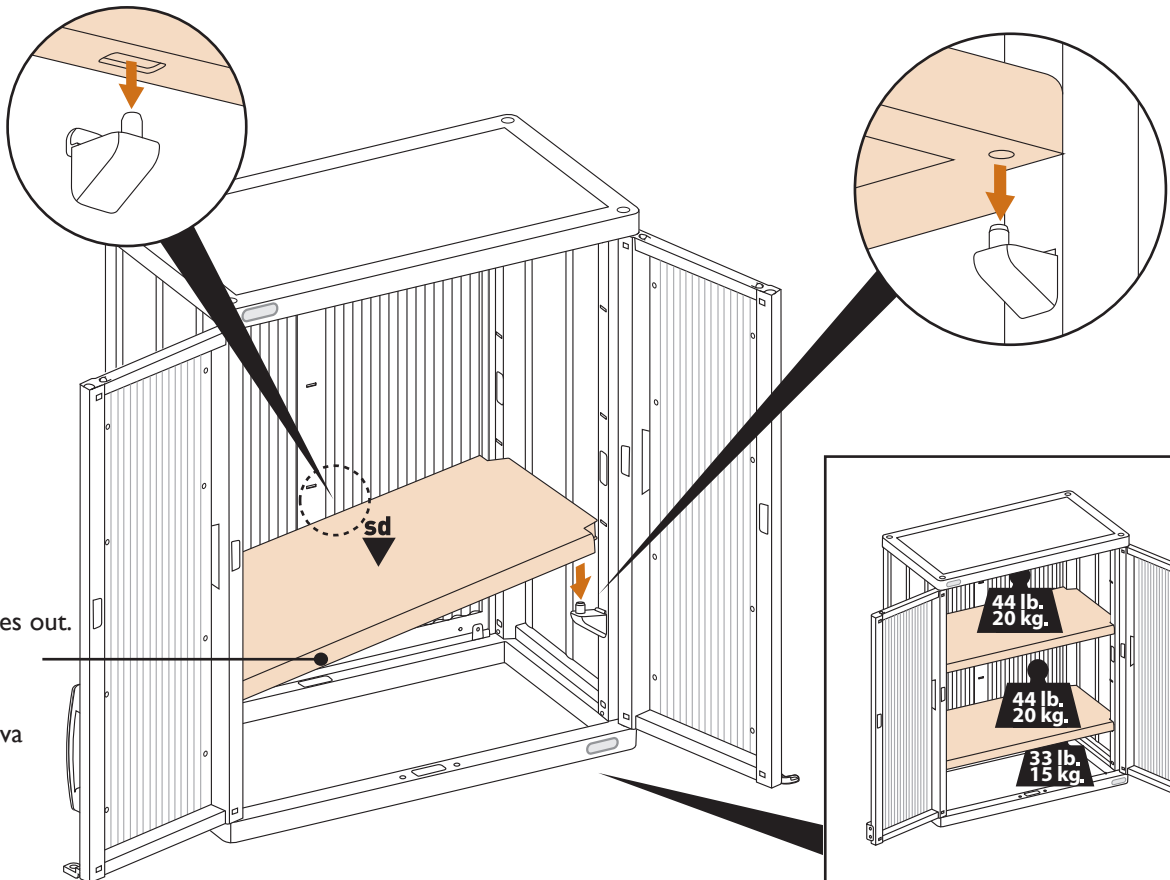



Made in the U.S.A. • Fabriqué aux É.-U. • Hecho en EE.UU.
US Leisure • Stanley NC 28164 • 1.877.638.7056