

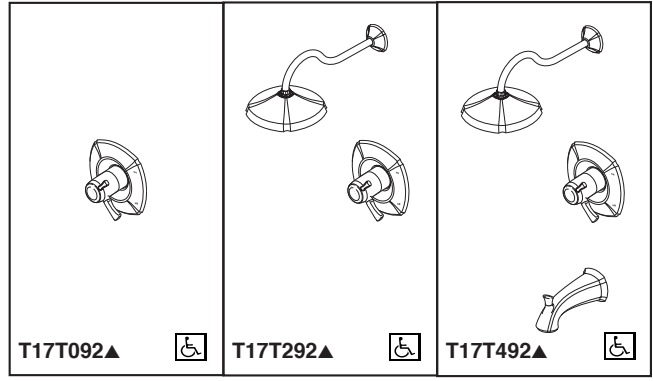

TUB AND SHOWER FAUCET TRIM



- Addison™ Bath Collection
- TempAssure® Thermostatic
- Valve Only (T17T092 Series)
- Shower Only (T17T292 Series)
- Tub/Shower (T17T492 Series)

Submitted Model No.: _____
 Specific Features: _____

FEATURES:

- TempAssure® 17T Thermostatic Valve Cartridge

STANDARD SPECIFICATIONS:

- Thermostatic wax element maintains the outlet temperature to $\pm 3.6^\circ\text{F}$
- Must also order Multi-Choice® Universal rough separately
- Back-to-back installation capability
- Solid brass forged body
- Lever volume control handle; temperature adjustment dial
- Graphics indicate hot/cold temperature adjustment
- Field adjustable to limit rotation into hot water zone
- All parts are replaceable from the front of the valve
- Adjusts for up to 1" wall thickness
- H₂Okinetic Technology® 2.50 gpm @ 80 PSI

WARRANTY

- Lifetime limited warranty on parts (other than electronic parts and batteries) and finishes: or, for commercial users, for 5 years from date of purchase.
- 5 year limited warranty on electronic parts (other than batteries); or, for commercial users, for 1 year from the date of purchase. No warranty is provided on batteries.

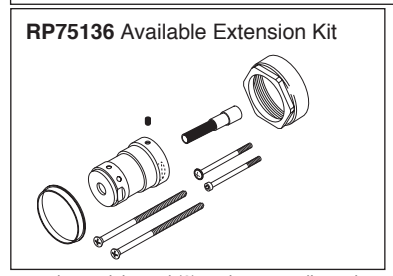
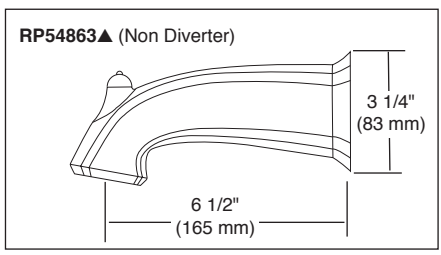
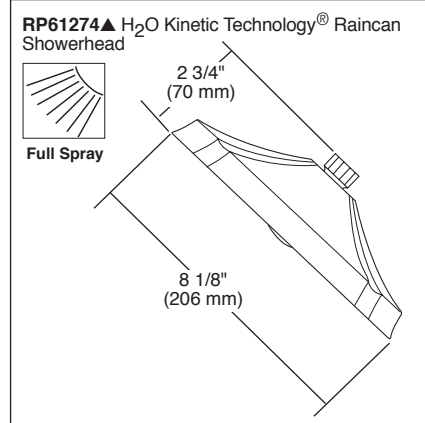
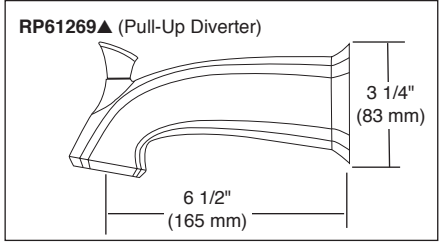
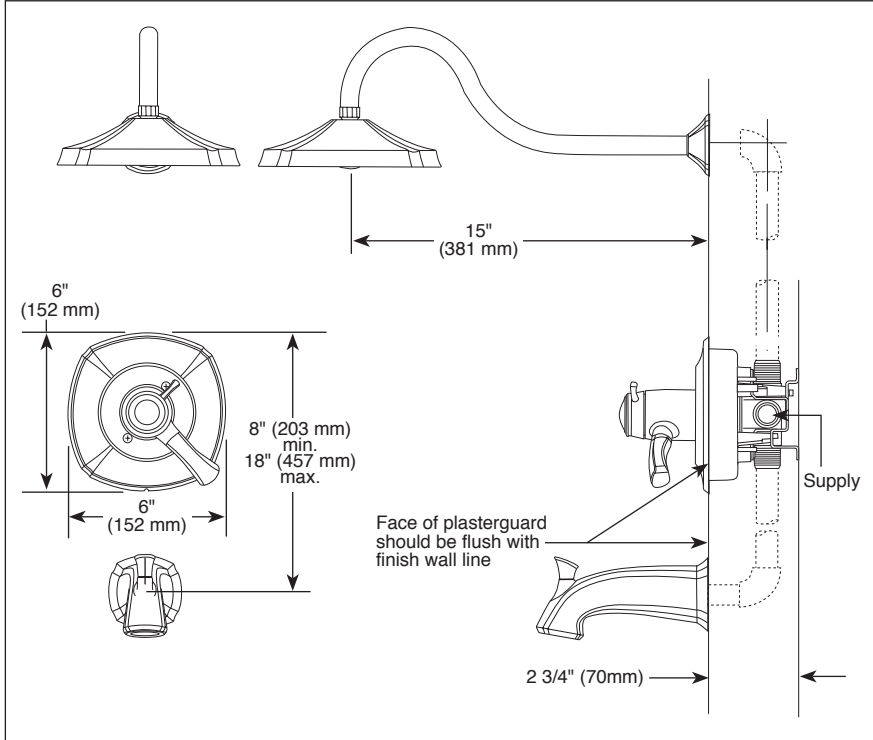

COMPLIES WITH:

- ASME A112.18.1 / CSA B125.1
- ASSE 1016
- ♿ Indicates compliance to ICC/ANSI A117.1 - Valve control only

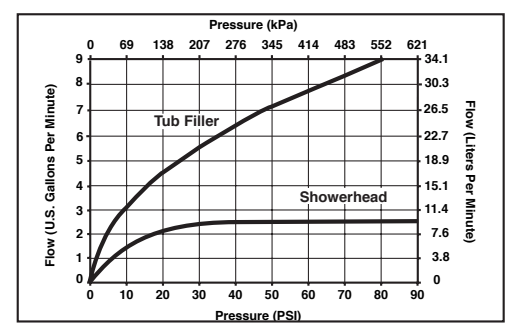

▲ Designate Proper Finish Suffix



55 E. 111th Street, Indianapolis, Indiana 46280
 350 South Edgeware Road, St. Thomas, ON N5P 4L1
 © 2016 Masco Corporation of Indiana

Delta reserves the right (1) to make changes in specifications and materials, and (2) to change or discontinue models, both without notice or obligation. Dimensions are for reference only. See current full-line price book or www.deltafaucet.com for finish options and product availability.
 DSP-B-T17T092 Rev. E