

HOME
DECORATORS
COLLECTION

Item #1001 636 086
Model #HD-1181

USE AND CARE GUIDE

2-LIGHT VANITY BAR

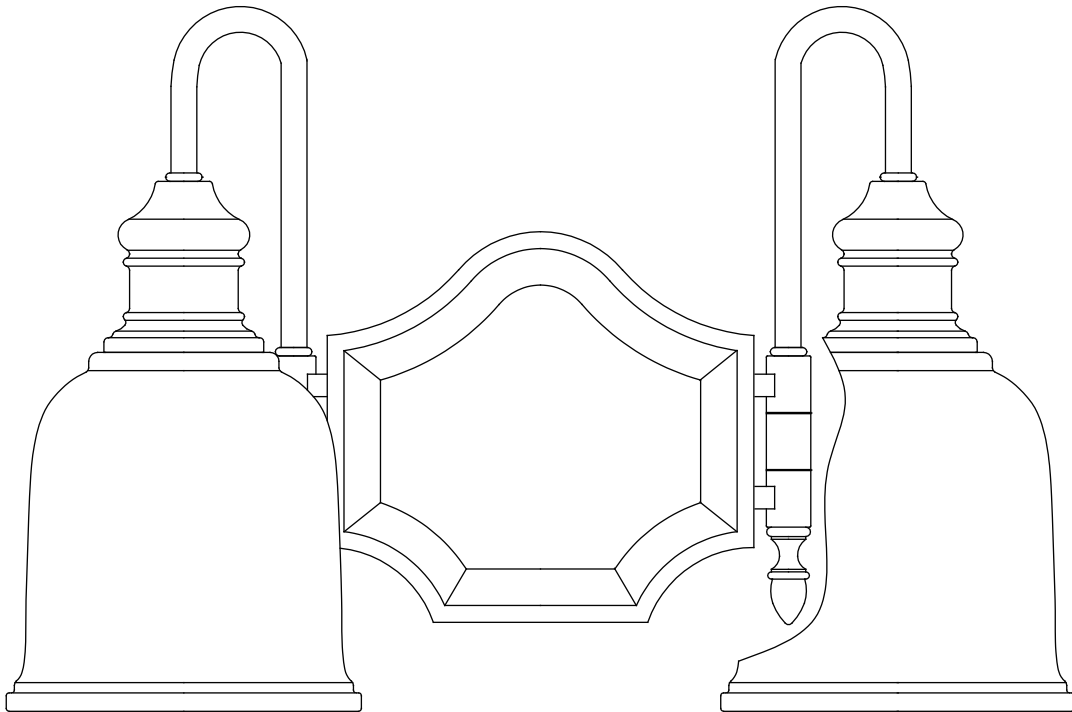

Questions, problems, missing parts? Before returning to the store,
call Home Decorators Collection Customer Service
8 a.m. - 6 p.m., EST, Monday - Friday

1-800-986-3460

HOMEDEPOT.COM/HOMEDECORATORS

THANK YOU

We appreciate the trust and confidence you have placed in Home Decorators Collection through the purchase of this 2-light vanity bar. We strive to continually create quality products designed to enhance your home. Visit us online to see our full line of products available for your home improvement needs. Thank you for choosing Home Decorators Collection!

Table of Contents

Table of Contents	2	Tools required	3
Safety Information	2	Hardware Included	3
Warranty	2	Package Contents	4
What is Covered	2	Installation	5
What is Not Covered	2	Care and Cleaning	7
Pre-Installation	3	Troubleshooting	7
Planning Installation	3		

Safety Information



WARNING: Carefully read and understand the information given in this manual before beginning the assembly and installation. Failure to do so could lead to electric shock, fire or other injuries which could be hazardous or even fatal.



WARNING: Be sure the electricity to the wires you are working on is shut off. Either remove the fuse or turn off the circuit breaker.

NOTICE: Change or modifications not expressly approved by the party responsible for compliance could void the user's authority to operate the equipment.

Warranty

WHAT IS COVERED

The manufacturer warrants this lighting fixture to be free from defects in materials and workmanship for a period of five (5) years from date of purchase. This warranty applies only to original consumer purchaser and only to products used in normal use and service. If this product is found to be defective, the manufacturer's only obligation, and your exclusive remedy, is the repair or replacement of the product at the manufacturer's discretion, provided that the product has not been damaged through misuse, abuse, accident, modifications, alterations, neglect or mishandling.

WHAT IS NOT COVERED

This warranty shall not apply to any product that is found to have been improperly installed, set-up, or used in any way not in accordance with the instructions supplied with the product. This warranty shall not apply to a failure of the product as a result of an accident, misuse, abuse, negligence, alteration, or faulty installation, or any other failure not relating to faulty material or workmanship. This warranty shall not apply to the finish on any portion of the product such as surface and/or weathering, as this is considered normal wear and tear.

The manufacturer does not warrant and specially disclaims any warranty, whether express or implied, of fitness for a particular purpose, other than the warranty contained herein. The manufacturer specifically disclaims any liability and shall not be liable for any consequential or incidental loss or damage, including but not limited to any labor/expense costs involved in the replacement or repair of said product.

Contact the Customer Service Team at 1-800-986-3460 or visit HOMEDEPOT.COM/HOMEDECORATORS.

Pre-Installation

PLANNING INSTALLATION

Read all instructions before assembly. Before starting installation of this fixture or removal of a previous fixture, disconnect the power by turning off the circuit breaker or by removing the fuse at the fuse box. To avoid damaging this product, assemble it on a soft, non-abrasive surface such as carpet or cardboard.



NOTE: Keep your receipt and these instructions for proof of purchase.



NOTE: This fixture can be installed as an up light or a down-light.

TOOLS REQUIRED



Flathead Screwdriver

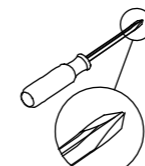

Phillips Screwdriver



Ladder

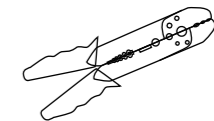

Wire Strippers

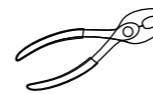

Pliers



Electrical Tape



Wire Cutters



Safety Glasses

HARDWARE INCLUDED



NOTE: Hardware not shown to actual size.

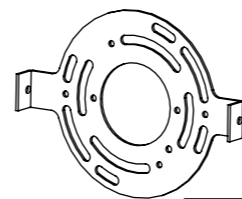

AA

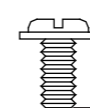

BB

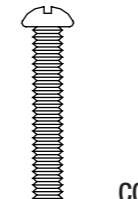

CC

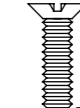

DD



EE

Part	Description	Quantity
AA	Cross bar	1
BB	Ground Screw	1
CC	Outlet Box Screw	2
DD	Mounting Screw	2
EE	Wire Connector	3

Pre-Installation (continued)

PACKAGE CONTENTS

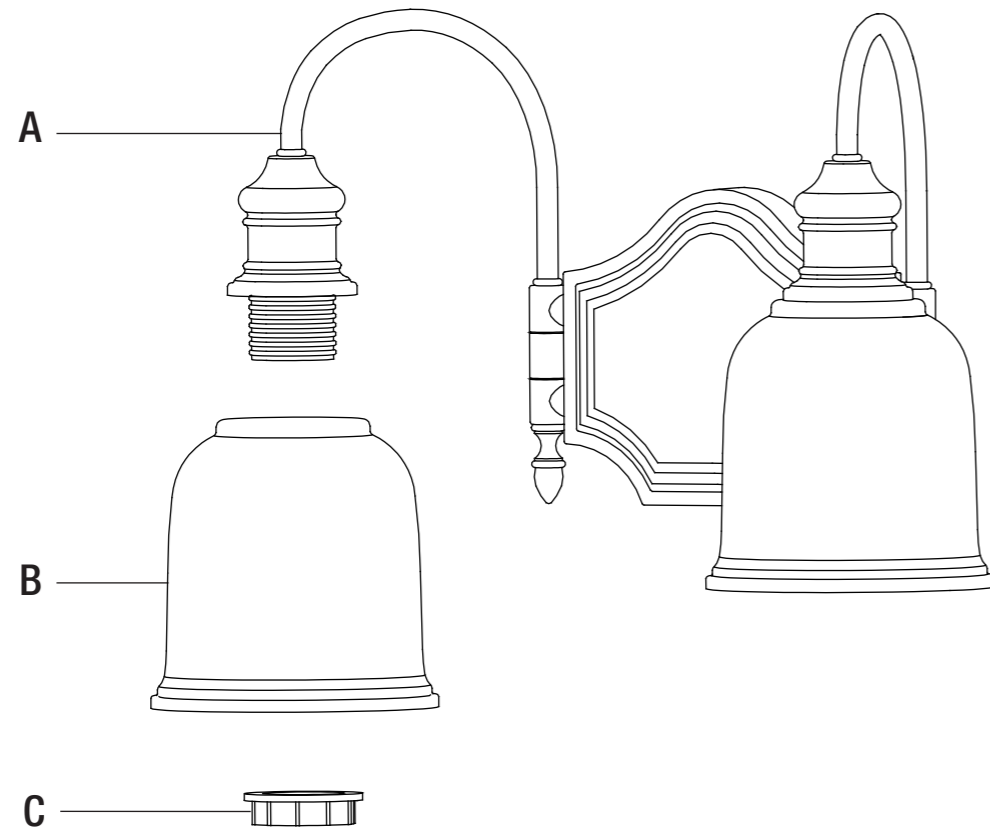

Part	Description	Quantity
A	Fixture	1
B	Shade	2
C	Socket ring (preassembled to Fixture (A))	2

Installation

1 Attaching the cross bar to the outlet box

- Mount the cross bar (AA) to the outlet box using the two outlet box screws (CC).

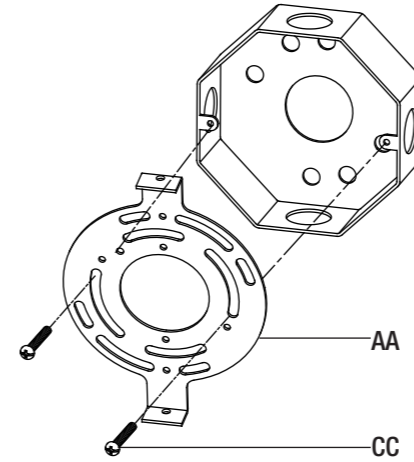

2 Connecting the electrical wires

- Wrap the ground wire from the fixture around the ground screw (BB) on the cross bar (AA). Connect the ground wire from the fixture to the ground wire from the outlet box.
- Connect the white wire from the fixture to the white wire (neutral wire) from the outlet box.
- Connect the black wire from the fixture to the black wire (live wire) from the outlet box.
- Cover the three connections using the three wire connectors (EE). Wrap the three wire connections with electrical tape for a more secure connection.
- Position the wires back inside the outlet box.

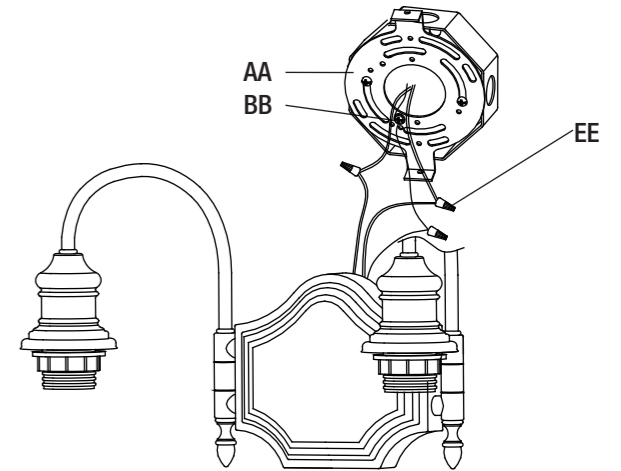

3 Securing the fixture to the outlet box

- Place fixture (A) over the cross bar (AA).
- Align the holes from the fixture and cross bar.
- Secure with mounting screws (DD).



NOTE: This fixture can be installed as an up-light or a down-light.

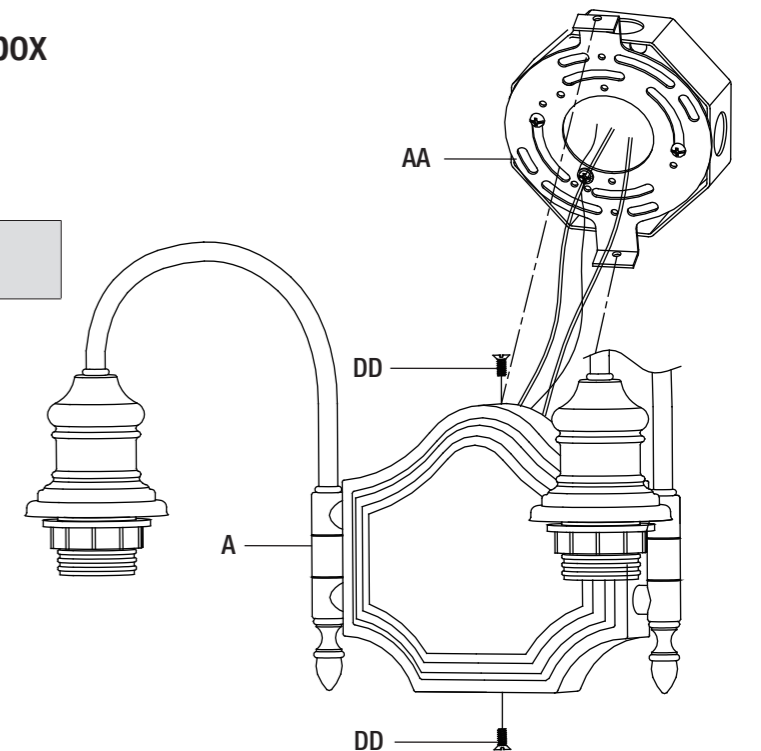

Installation (continued)

4 Securing the shades

- Screw down the socket rings (C) from the sockets.
- Place the shades (B) over the sockets.
- Screw back the socket rings (C) on the sockets.

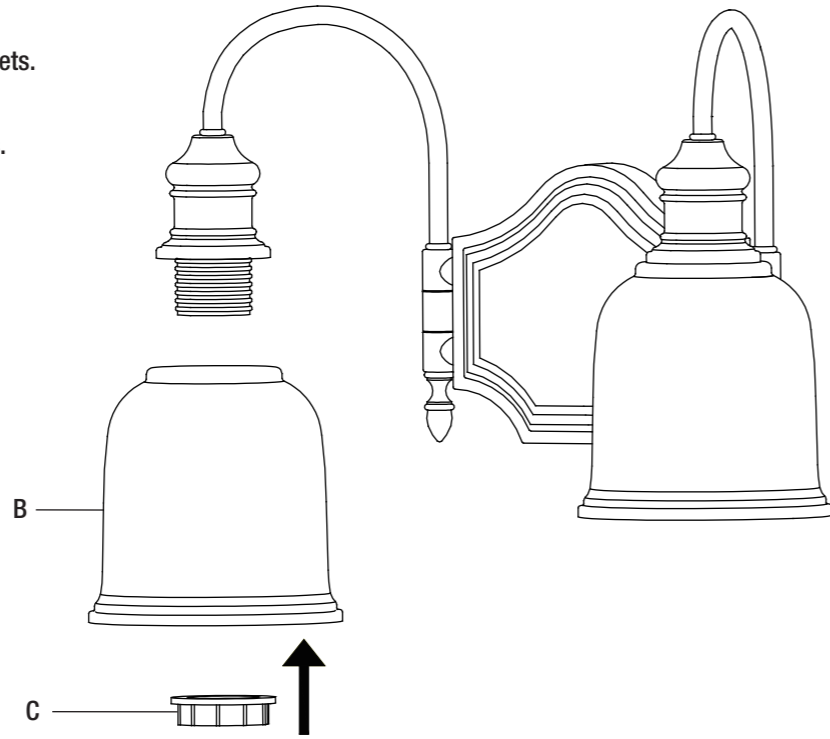

5 Installing the bulbs

- Screw the bulbs (not included) into the sockets.

NOTE: CFL equivalent energy-saving bulbs can be used that do not exceed 13 Watts each (sold separately).

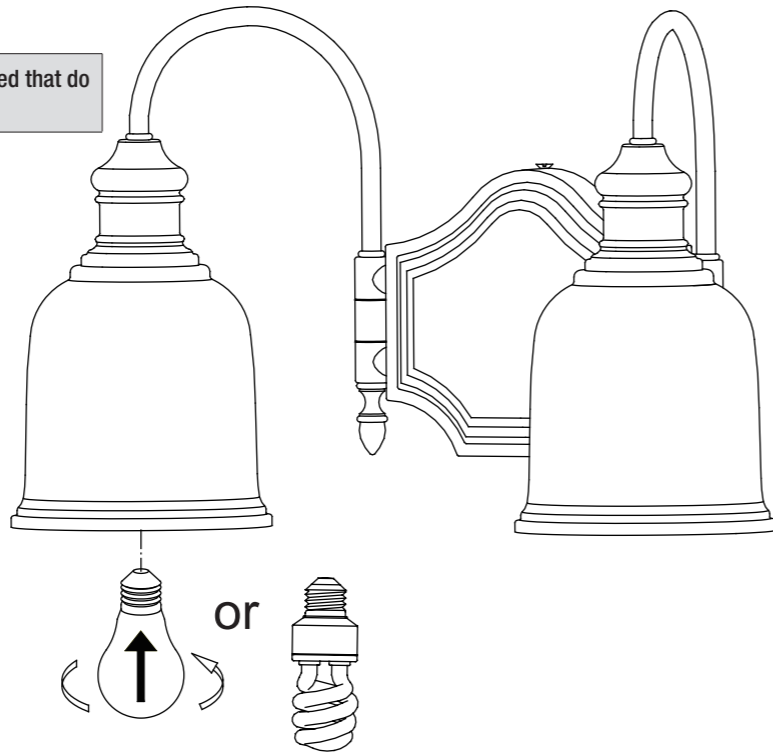

Care and cleaning

- Clean the fixture with a soft, dry cloth.
- Do not use any cleaners with chemicals, solvents or harsh abrasives.



CAUTION: Before attempting to clean the fixture, disconnect the power to the fixture by turning the breaker off or removing the fuse from the fuse box.

Troubleshooting

Problem	Possible cause	Solution
The fixture will not light.	The power is off.	Ensure the power supply is On.
	The circuit breaker is off.	Ensure the circuit breaker is in the On position.
The fuse blows or the circuit breaker trips when the light is turned on.	The wires are crossed or the power wire is grounding out.	Check the wire connections. Contact a qualified electrician or call the Customer Service Team at 1-800-986-3460.

HOME DECORATORS COLLECTION

Questions, problems, missing parts? Before returning to the store,
call Home Decorators Collection Customer Service
8 a.m.-6 p.m., EST, Monday-Friday

1-800-986-3460

[HOMEDEPOT.COM/HOMEDECORATORS](https://www.homedepot.com/homedecorators)

Retain this manual for future use.