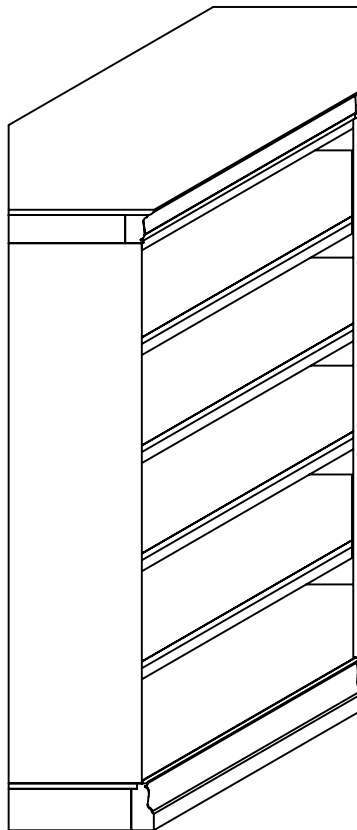


# HOME DECORATORS COLLECTION

INV# 97163

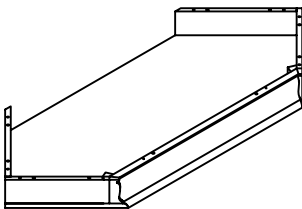
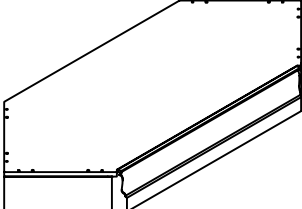
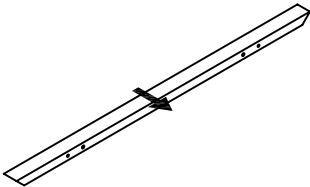
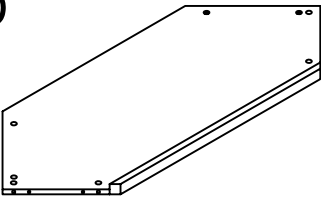
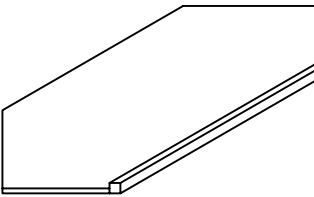
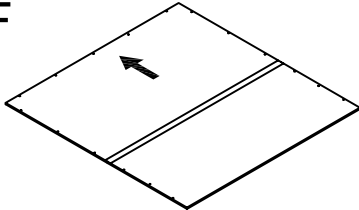
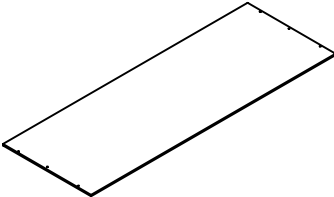
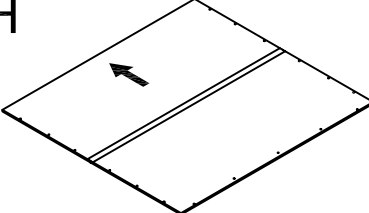
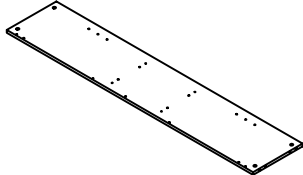
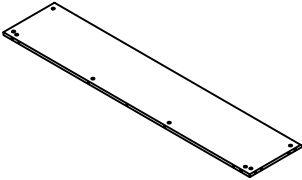
SK18385 LOUIS PHILIPPE MODULAR CORNER BOOKCASE 73"Hx47.75"Wx19.8"D  
ASSEMBLY INSTRUCTIONS

Made In China




Thank you for purchasing this quality product. Be sure to check all packing material carefully for small parts, which may have come loose inside the carton during shipment. Count all parts and material hardware, then compare with parts list to be sure all parts are present, If any parts are missing or damaged, phone, fax, or mail to our Customer service Department for efficient and speedy service. Please indicate the model number and code letter of part(s) needed.

**IMPORTANT NOTE:** Follow instructions listed below in proper sequence as numbered to assure fast,easy and correct assembly.

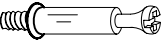
<b>PARTS LIST</b>		
<b>A</b> 	<b>B</b> 	<b>C</b> 
TOP PANEL-1PC	BOTTOM PANEL-1PC	FRONT CROSS BRACE-1PC
<b>D</b> 	<b>E</b> 	<b>F</b> 
FIXED PANEL-2PCS	ADJUSTABLE SHELF-2PCS	TOP BACK PANEL-1PC
<b>G</b> 	<b>H</b> 	<b>I</b> 
MIDDLE BACK PANEL-1PC	BOTTOM BACK PANEL-1PC	FRONT SIDE PANEL-2PCS
<b>J</b> 		
BACK SIDE PANEL-2PCS		

**a**




WOOD DOWEL-40PCS

**b**



CAM LOCK BOLT-40PCS

**c**




CAM LOCK-40PCS

**d**



PLASTIC COVER-24PCS

**e**




1" L FLAT  
HEAD SCREW-2PCS

**f**




SHELF PIN-8PCS

**g**

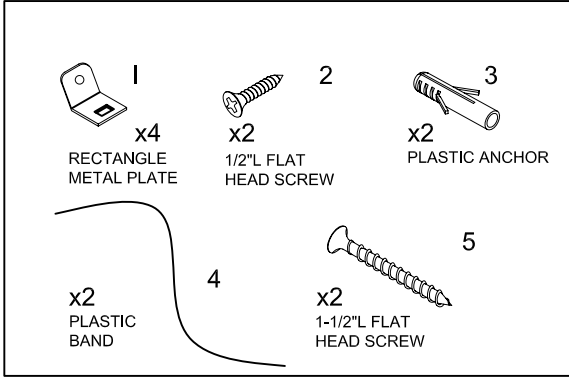


1/2" L ROUND  
HEAD SCREW-48PCS

**h**



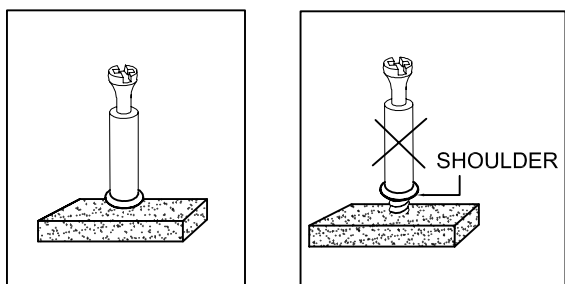
METAL PLATE-8PCS



ANTI-TIPPING HARDWARE PACKAGE

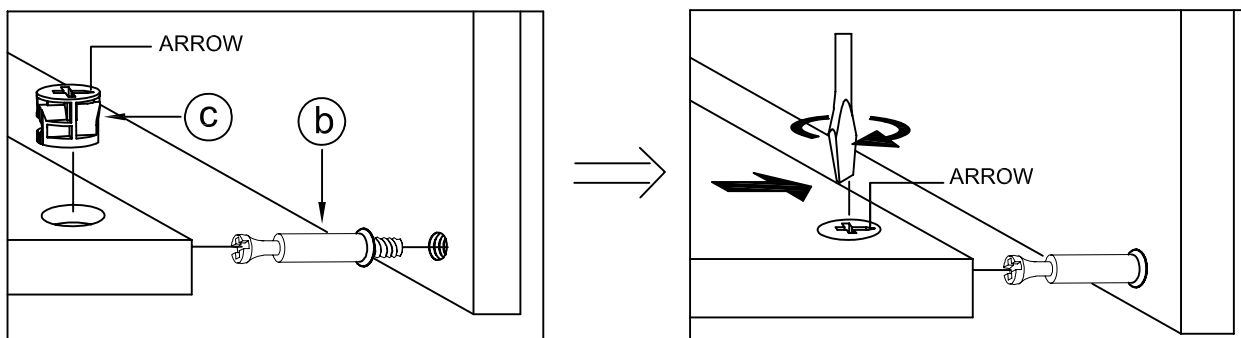
NOTE:THE SURFACE WITH THE STICKER IS THE BACK SIDE

NOTE: • UPON OPENING, THOROUGHLY CLEAN ALL WOOD SURFACES TO REMOVE DUST AND DIRT THAT MAY HAVE SETTLED ONTO THE FINISH DURING SHIPMENT. IN ORDER TO PREVENT DAMAGE DURING ASSEMBLY. PLEASE ASSEMBLE THIS ITEM WITH AT LEAST TWO PEOPLE.



NOTE: TURN THE CAM-BOLT SCREWS UNTIL THEY ARE TIGHT, THE SHOULDER SHOULD BE AGAINST THE SURFACE OF THE PART.

## HOW TO USE THE CAM-TOOL

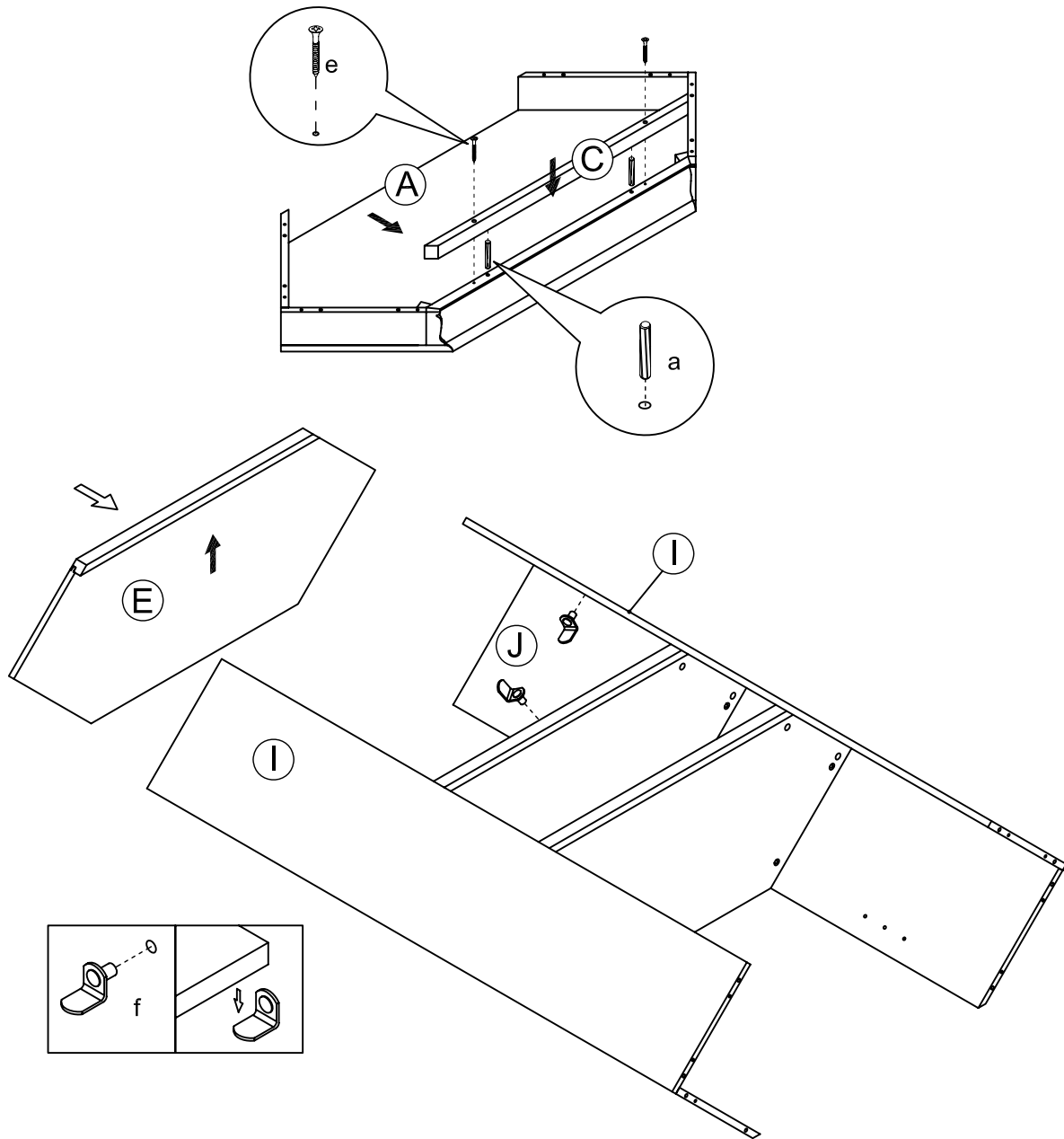


NOTE: • THE ARROWS ON THE HIDDEN CAM-LOCKS SHOULD POINT TO THE CAM-BOLTS.



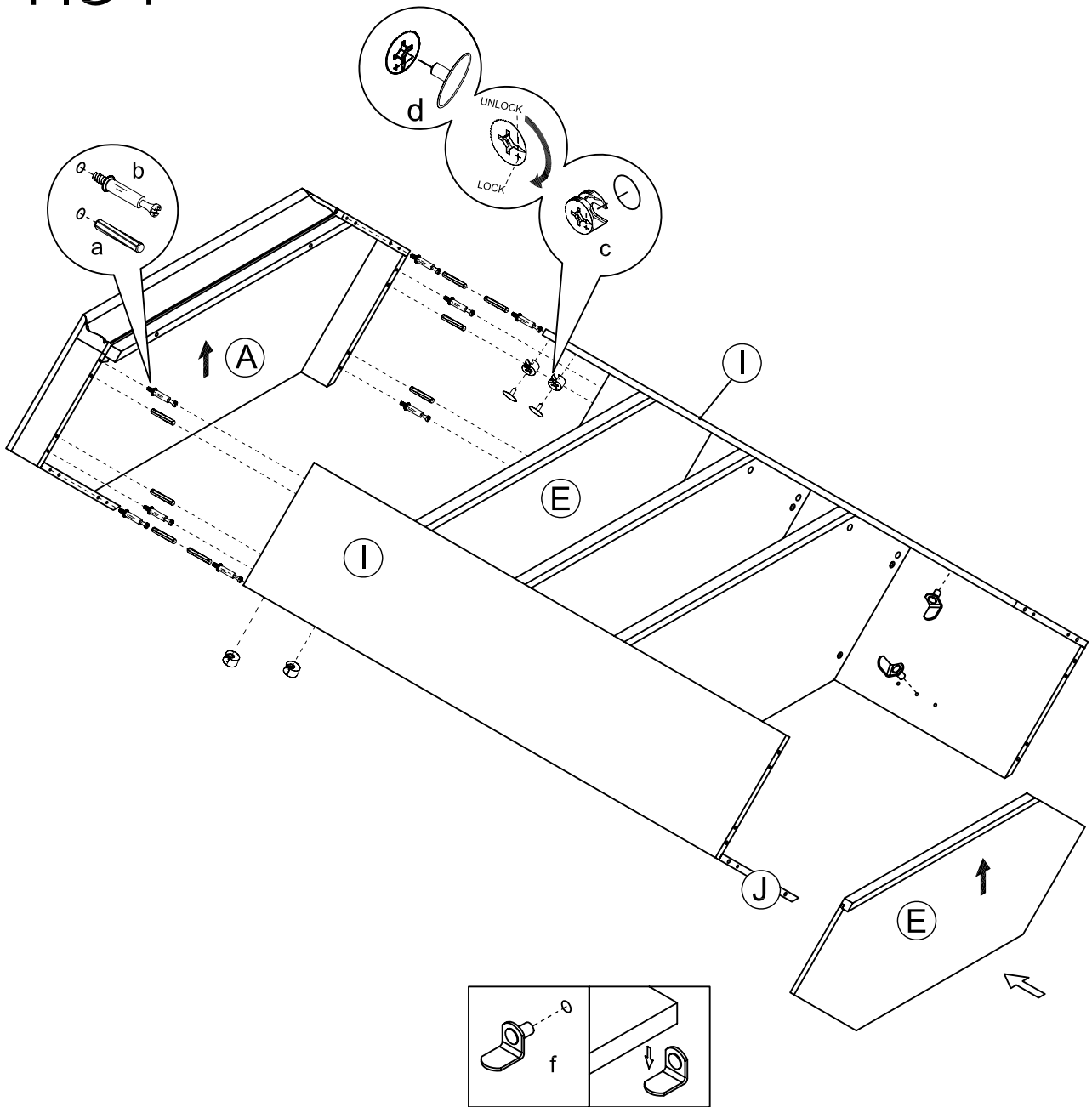


FIG 3



- INSTALL THE WOOD DOWEL (a) INTO THE TOP PANEL (A).
- JOIN THE FRONT CROSS BRACE (C) TO THE TOP PANEL (A) BY USING WOOD DOWEL (a) FIRST.
- TIGHTEN THE FRONT CROSS BRACE (C) BY USING THE 1" FLAT HEAD SCREW (e) AS SHOWN.
- INSERT THE SHELF PIN (f) IN THE DESIRED POSITION AND THEN PLACE THE ADJUSTABLE SHELF (E) ON THE PINS.

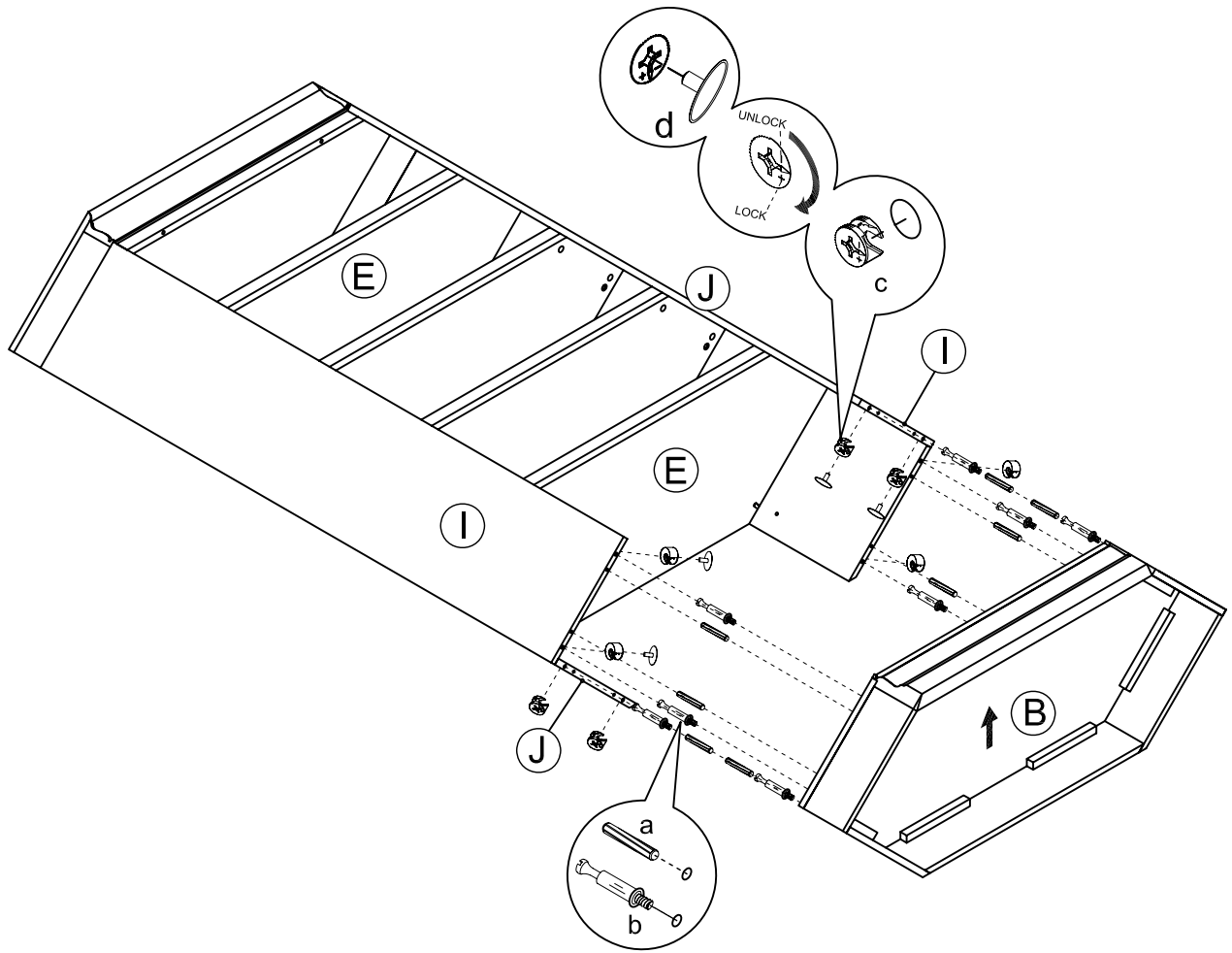
FIG 4



- INSTALL THE WOOD DOWEL (a) AND THE CAM LOCK BOLT (b) INTO THE TOP PANEL (A).
- JOIN THE TOP PANEL (A) TO THE ASSEMBLED PART BY USING WOOD DOWEL (a) FIRST.
- TIGHTEN THE CAM LOCK BOLT (b) WITH THE CAM LOCK (c) IN PRE-DRILLED HOLES.
- COVER THE CAM HOLES WITH PLASTIC COVER (d).
- INSERT THE SHELF PIN (f) IN THE DESIRED POSITION AND THEN PLACE THE ADJUSTABLE SHELF (E) ON THE PINS.

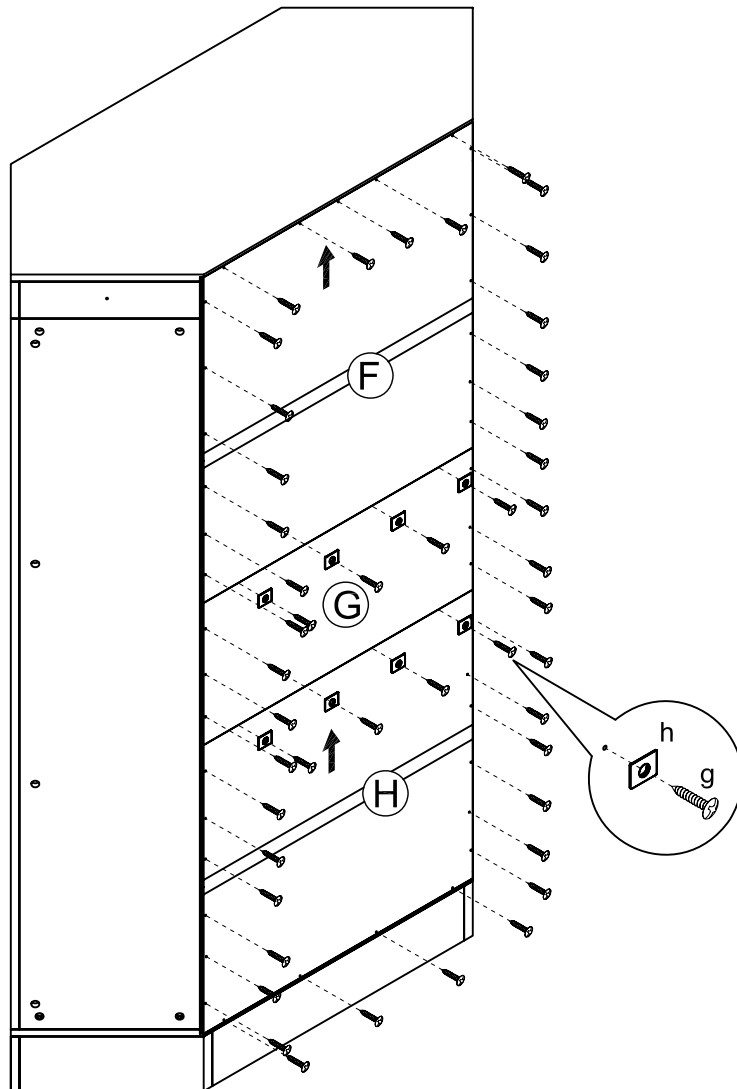


FIG 5



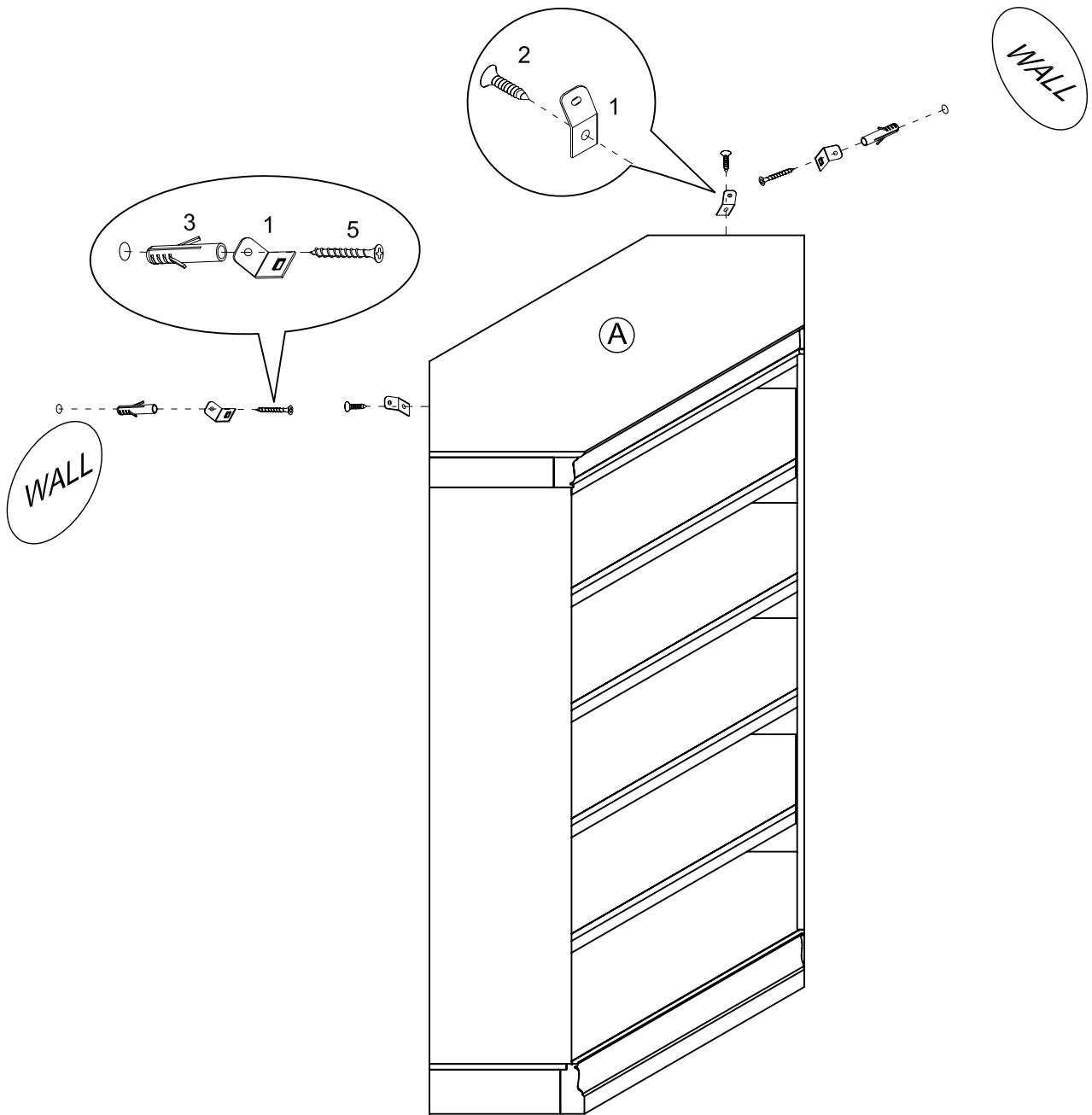
- INSTALL THE WOOD DOWEL (a) AND THE CAM LOCK BOLT (b) INTO THE BOTTOM PANEL (B).
- JOIN THE BOTTOM PANEL (B) TO THE ASSEMBLED PART BY USING WOOD DOWEL (a) FIRST.
- TIGHTEN THE CAM LOCK BOLT (b) WITH THE CAM LOCK (c) IN PRE-DRILLED HOLES.
- COVER THE CAM HOLES WITH PLASTIC COVER (d).

FIG 6



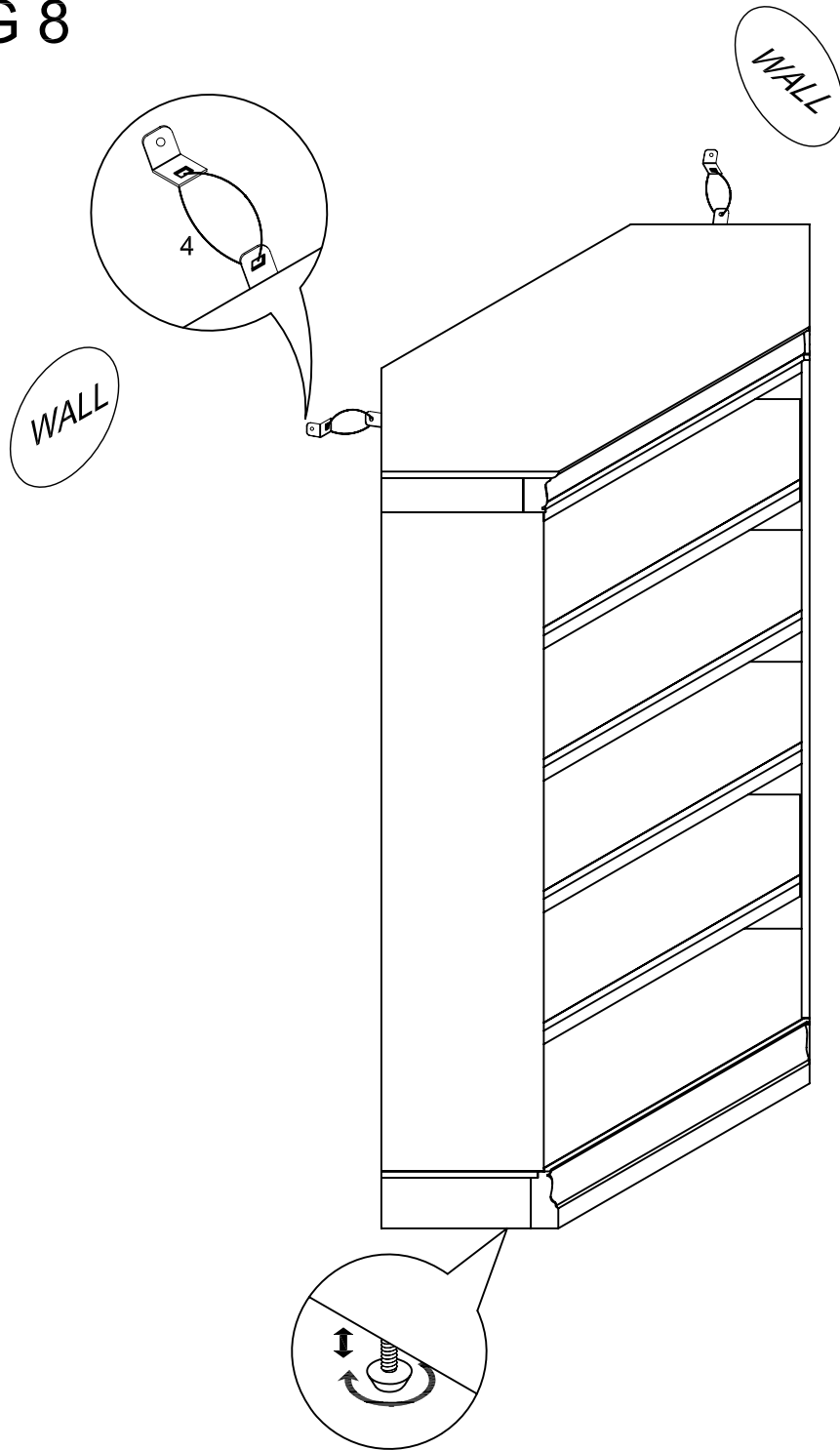
- TIGHTEN THE TOP BACK PANEL (F), THE MIDDLE BACK PANEL (G) AND BOTTOM BACK PANEL (H) BY USING THE 1/2" ROUND HEAD SCREW (g) AND THE METAL PLATE (h).

# FIG 7



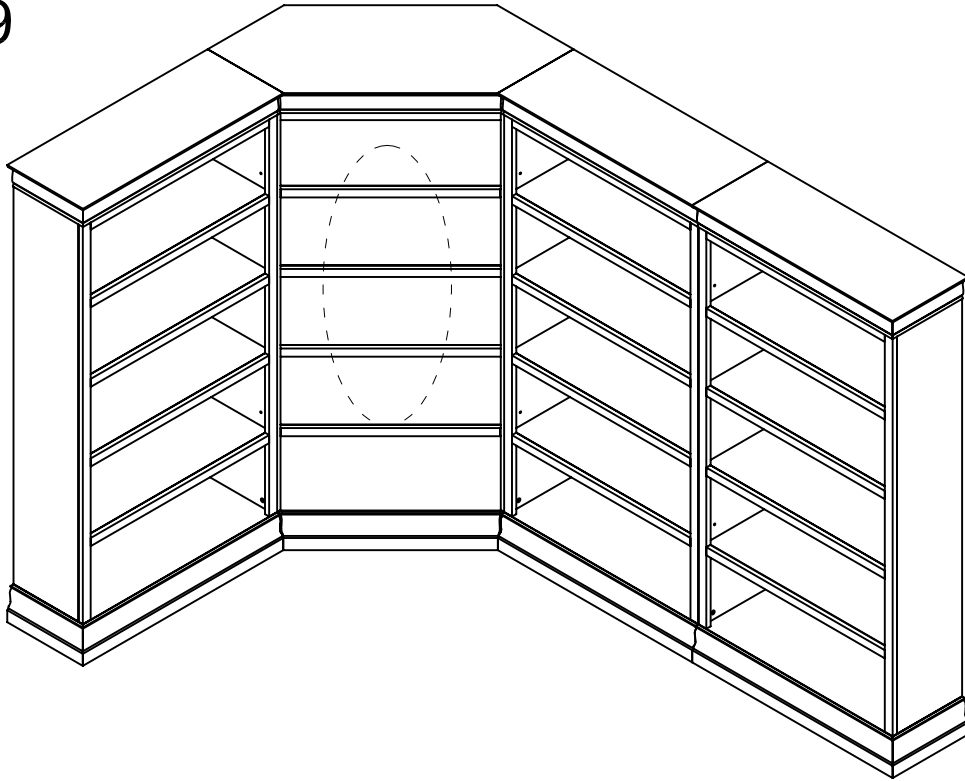
- TIGHTEN THE RECTANGLE METAL PLATE (1) TO THE REAR OF THE TOP PANEL (A) BY USING 1/2" FLAT HEAD SCREW (2).
- PLACE THE ASSEMBLED CORNER BOOKCASE AT THE DESIRED POSITION. MARK THE INSERTION POINTS FOR THE PLASTIC ANCHOR (3).
- USING THE PROPER HARDWARE FOR YOUR WALL TYPE, DRILL 1/4" HOLES INTO THE WALL.
- TIGHTEN THE RECTANGLE METAL PLATE (1) TO THE PLASTIC ANCHOR (3) BY USING THE 1-1/2" FLAT HEAD SCREW (5).

FIG 8

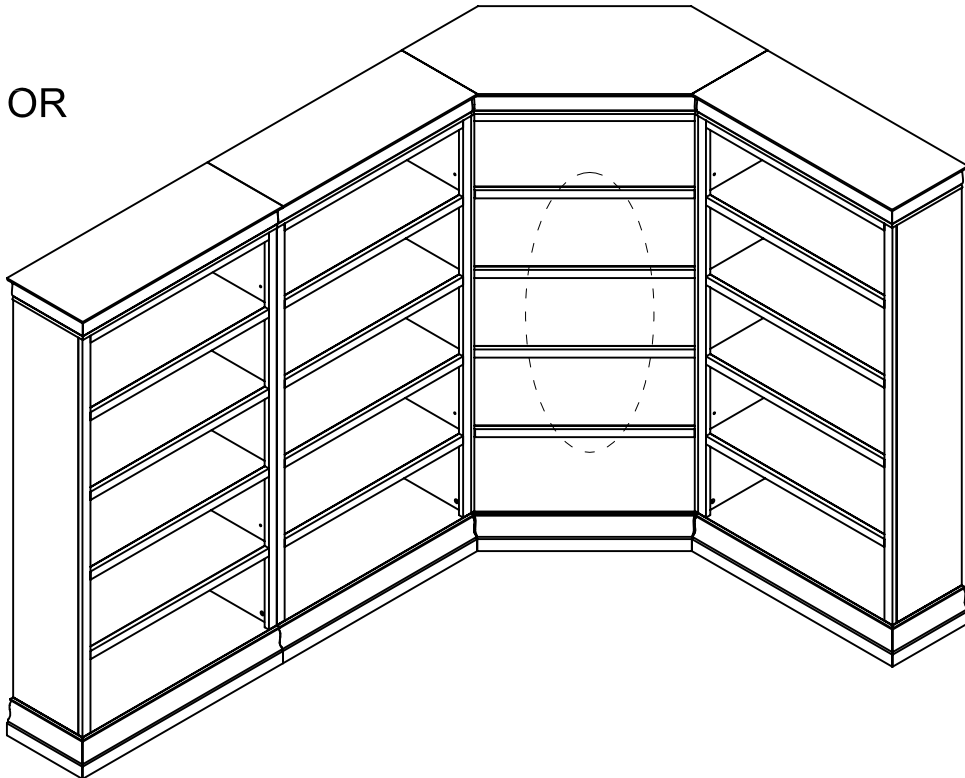


- USING THE PLASTIC BAND (4) CONNECT TWO RECTANGLE METAL PLATES (1).

FIG 9



OR



• PLACE UNITS IN ORDER AS SHOWN.