

ROOM DIVIDERS NOW

Hanging Rod Installation Instructions for CEILING MOUNTING

See other side for WALL MOUNTING instructions

Tools Required:

1. Drill with 3/16" drill bit

2. Phillips-head screwdriver

Parts List

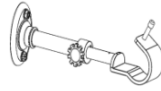

I. Hanging Rod
36-56" 2 tubes
56-108" 2 tubes
108-168" 4 tubes

II. Brackets
36-56" 2 brackets
56-108" 3 brackets
108-168" 3 brackets

III. Wall mount anchors and screws
36-56" 4-anchors; 4-screws
56-108" 6-anchors; 6 screws
108-168" 6-anchors; 6-screws

Bracket Installation

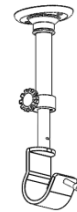
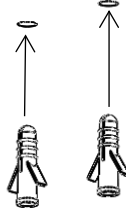
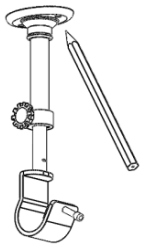

1. Using the bracket as a template, place it in the desired location. Mark holes.

2. Drill 3/16" holes on pencil marks and insert anchors until they are flush with the ceiling.

3. Remove hook from the bracket by loosening the set screw and then screw the bracket to the ceiling.

4. Attach the hook to the bracket. Attached bracket should look like this.

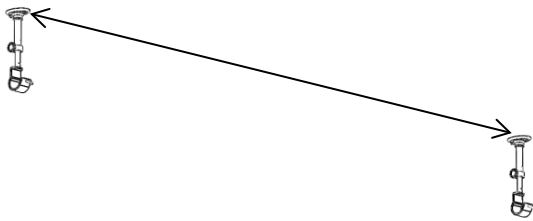

Brackets must align.

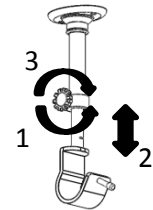
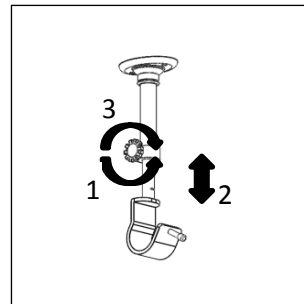

5. Install the other bracket in the same way as steps 1-4. Typically, the brackets should be the same distance from the nearest parallel wall.

6. Adjust the bracket length by loosening the set screw counter-clockwise and moving the hanger hook inward or outward and then tighten in clockwise motion.

7. Adjust the other bracket to the same length as 1st and hand-tighten screw.

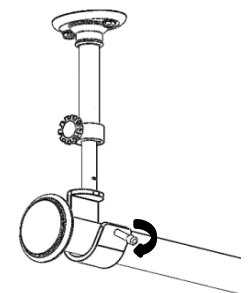
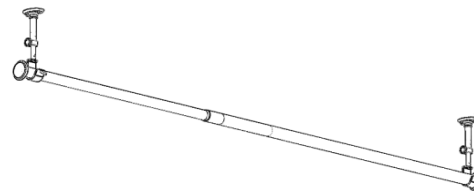
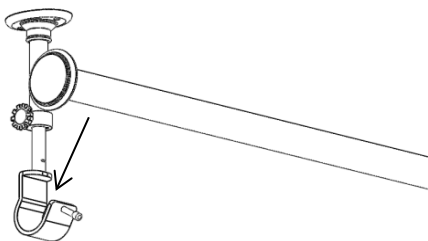

8. Place the curtain onto the hanging rod (Curtain not shown). Place one end of the hanging rod into one bracket.

9. Place the hanging rod onto the other hanging bracket. (Curtain not shown). For additional support, install the third bracket (56-108" & 108-168" only).

10. Tighten set screws on each bracket to secure the rod.

ROOM DIVIDERS NOW

Curtain Rod Pole Installation Instructions for WALL MOUNTING



See other side for CEILING MOUNTING instructions

TOOLS REQUIRED

1. Drill with 0,5 cm drill bit

2. Phillips screwdriver

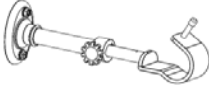
PARTS LIST

 <p>I. Curtain Rod Pole 91-142 cm - 2 tubes 142-274 cm - 2 tubes 274-427 cm - 4 tubes</p>	 <p>II. Brackets 91-142 cm - 2 brackets 142-274 cm - 3 brackets 274-427 cm - 4 brackets</p>	 <p>III. Wall mount anchors and screws 91-142 cm - 4-anchors; 4-screws 142-274 cm - 6-anchors; 6 screws 274-427 cm - 8-anchors; 8-screws</p>
--	--	---

INSTALLATION INSTRUCTIONS

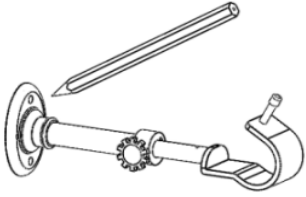
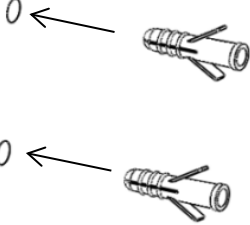
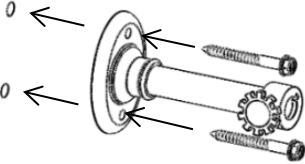
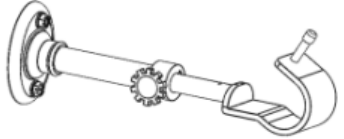
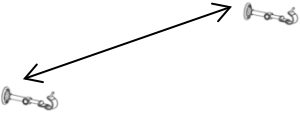
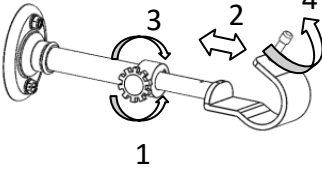
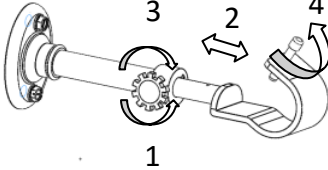
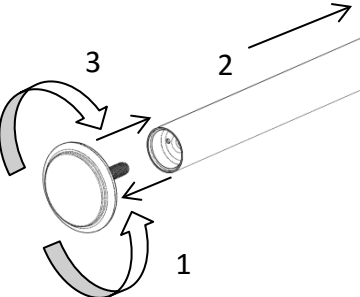
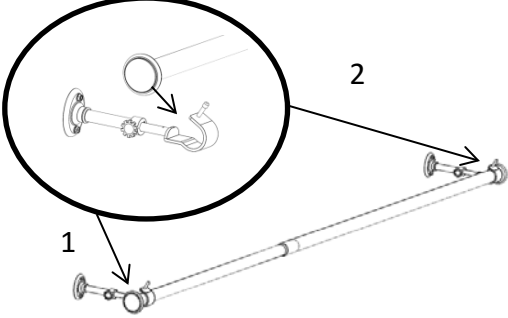
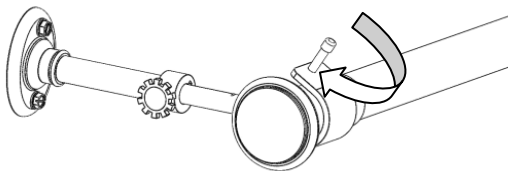
 <p>1. Using the bracket as a template, place it in the desired location. Mark holes.</p>	 <p>2. Drill the 0,5 cm holes on pencil marks and insert anchors until they are flush with the wall.</p>	 <p>3. Remove the hook from the bracket by loosening the set screw and then screw the bracket to the wall.</p>	 <p>4. Attach the hook to the bracket. Attached bracket should look like this.</p>
 <p>5. Install the other end bracket in the same way as steps 1-4. Using a level can ensure straightness.</p> <p>Top holes should be at the same height.</p>	 <p>6. Adjust bracket length by turning set screw counter-clockwise (1). Move hook in or out (2). Hand-Tighten set screw (3). Loosen hook set screw (4).</p>	 <p>7. Adjust the other bracket(s) to the same length as the first bracket and hand-tighten screw.</p>	 <p>8. Remove End Cap by turning counter-clockwise (1). Place the curtain onto the rod (Curtain not shown) (2). Replace End Cap by screwing threaded end into hole in a clockwise motion until seated. (3)</p>
 <p>9. Place the rod into the brackets (1)(2) (Curtain not shown). For additional support, install the extra bracket(s), if needed. (141-274 cm & 274-427 cm only).</p>	 <p>10. Hand-Tighten the two hook set screws on each bracket to secure the rod.</p>	<p>Congratulations!</p> <p>You've successfully installed your new curtain rod pole.</p> <p>Additional installation instructions can be found at RoomDividersNow.com</p>	