

SereneLife



SLPAC105W

Portable Air Conditioner

Compact Home A/C Cooling Unit with Built-in Dehumidifier
& Fan Modes, Includes Window Mount Kit (10,000 BTU)

USER MANUAL

Read all instructions carefully before setting up and operating the unit.

Please keep this instruction manual for future reference. This manual is designed to provide you with important information needed to setup, operate, maintain and troubleshoot your portable air conditioner. Failure to follow these instructions may damage and/or impair operation and void the warranty.

CONTENTS

User Tips

Precautions 3

Safety Warnings 5

Tips 8

Product Overview

Main Components 9

Control Panel and Remote Control 10

Operation

Place and Install 11

How to Operate 15

Clean and Maintenance

Drainage 16

Body Clean 16

Common Failures and Diagnosis

Intelligent Error Detection 18

Troubleshooting 19

Features and Technical Specs

..... 20

USER TIPS



Please avoid such operations, in case of any safety and health risks.



Such instructions are to be followed, for safety and health concerns.

PRECAUTION

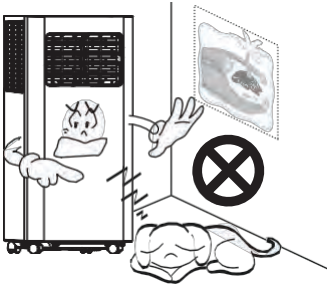

For household use only

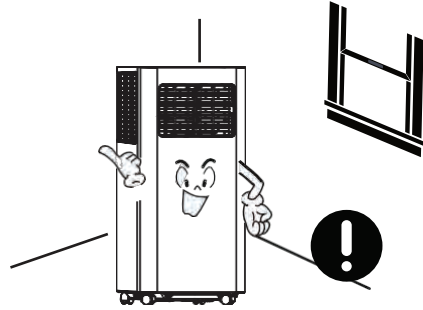

For indoor use only;
please place the A/C in a dry
environment.

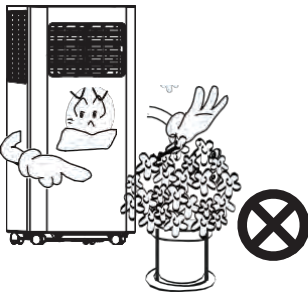

In case of a blocked air
exchange, never stack any
items around the machine.

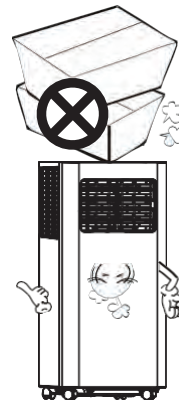

To avoid damages, never place
any heavy items on the machine.

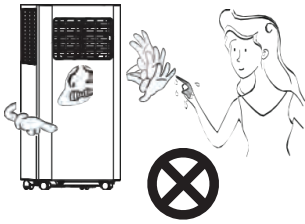

Do not operate the machine with wet hands or in a humid environment.

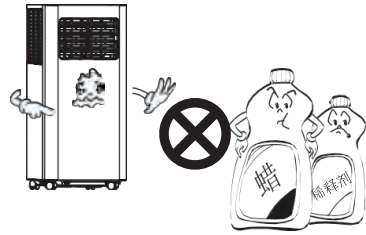

Please wipe the machine with a soft cloth, instead of wax, diluent or irritant detergent.

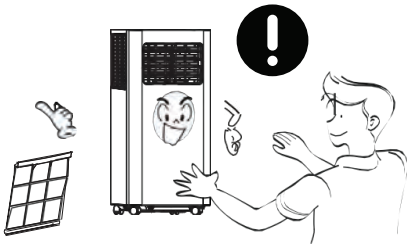

Clean the filter once every two weeks



For your health, never drink condensed water discharged from the machine.

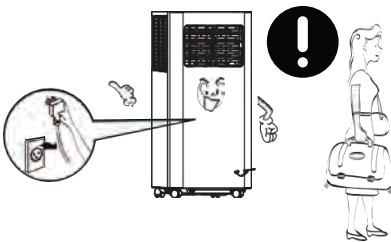

Please unplug the power cord, if the machine will not be used for a long time.



Non-professionals are not allowed to dismantle or repair the machine.

SAFETY WARNINGS



Damaged power cord or plug shall not be used. Never plug to a loose socket.

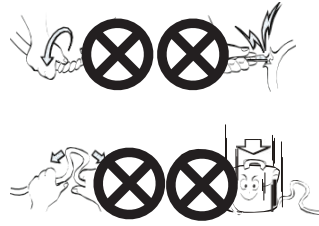

Never damage the power cord, or use unlicensed power cord. Make sure voltage is right.

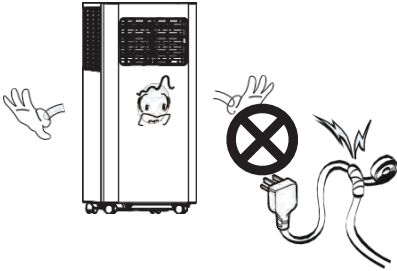

Do not modify or extend the power cord.

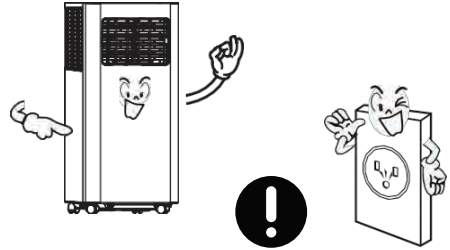

A grounded outlet is suggested for the machine.



In case of electric shock, never plug/unplug with wet hands.



To unplug, pull the plug end instead of wires.

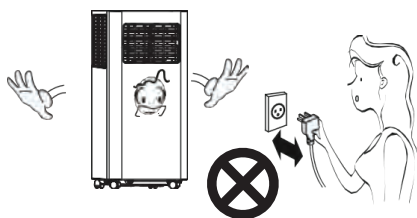

Never control on/off status by directly plugging/unplugging.

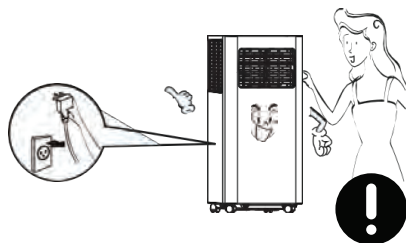

Please turn off the machine before unplugging.

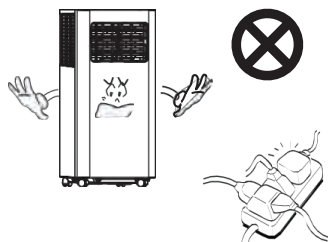

Never overload the socket.

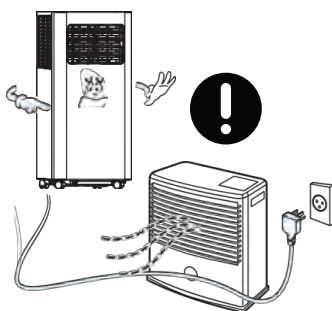

Keep away from heat sources or direct sunlight exposure.

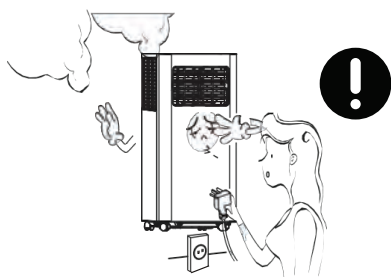

If there is any actual noise, smell or smoke, turn off and unplug for diagnosis.

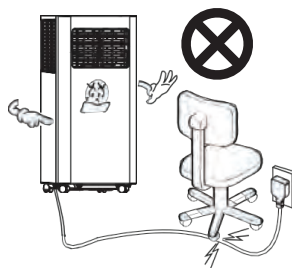

In case of electric shock, never damage the power cord by placing heavy objects on it.

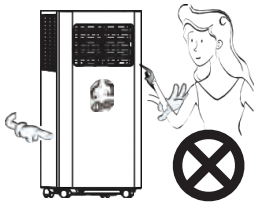

Never insert fingers or any hard objects into the louver.



Keep electrical parts away from water.



If water enters, turn off and unplug in time; and call for check and repair from a professional.

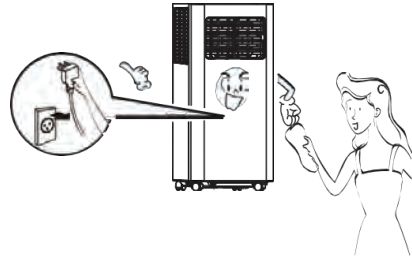

Please turn off and unplug before wiping, cleaning or replacing components.

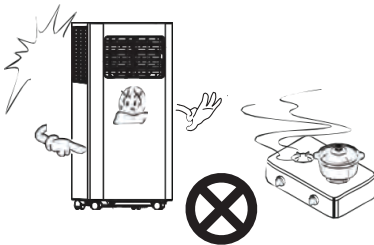

If gas leakage happens, open the window for ventilation before plugging the machine.

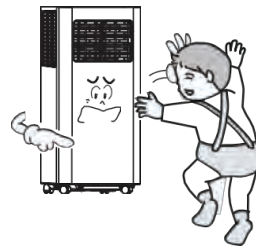

The appliance can be used by children of or above 8 years old and persons with reduced physical, sensory or psychological capabilities, if they have been given supervision and instruction concerning proper use and hazards of the appliance.

TIPS

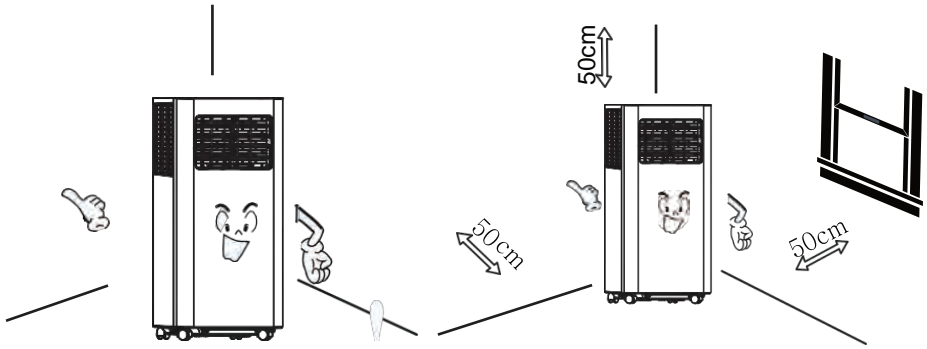

For a proper work of compressor, place the machine vertically on an even ground.

For a proper ventilation, keep the machine at least 50cm from objects nearby.

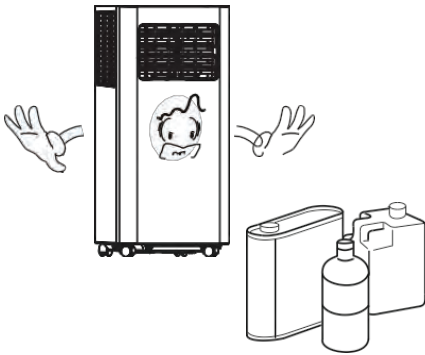

Never use the appliance near gasoline or other flammable objects.

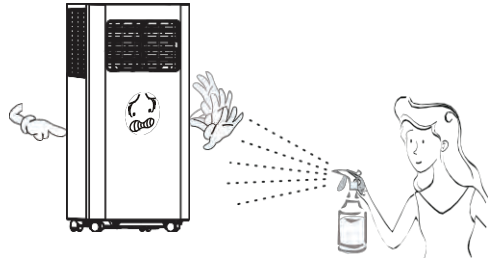

Keep the appliance from spraying agent or any solvent, or plastics may deform and electrical parts may even be damaged.

PRODUCT OVERVIEW

Main Components

1. Handle
2. Air Inlet Grille (Up)
3. Control Panel
4. Casters
5. Louver
6. Air Outlet Grille
7. Drainage Hole
8. Air Inlet Grille (Down)
9. Air Exhaust Duct Assembly
10. Window Sealing Kit

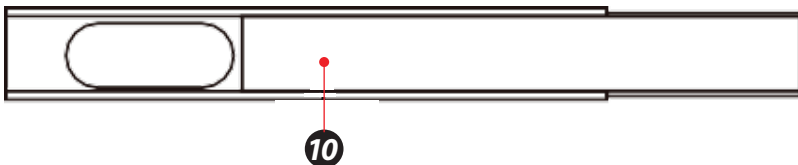
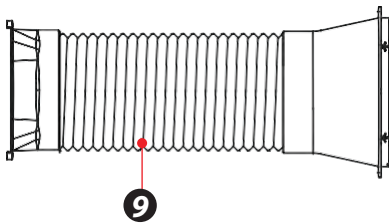
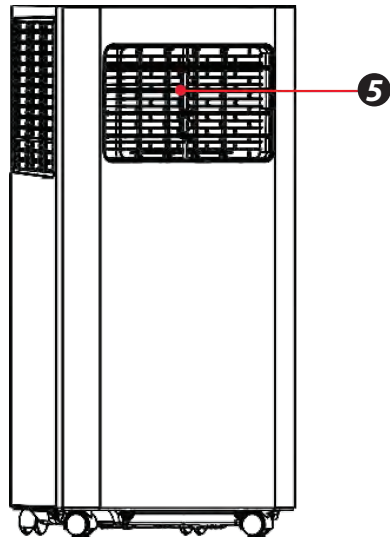
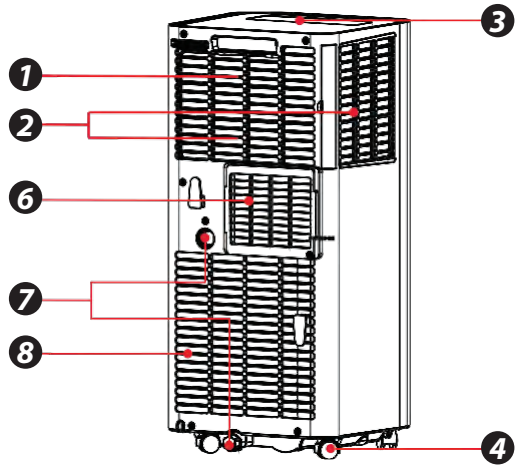

CONTROL PANEL AND REMOTE CONTROL

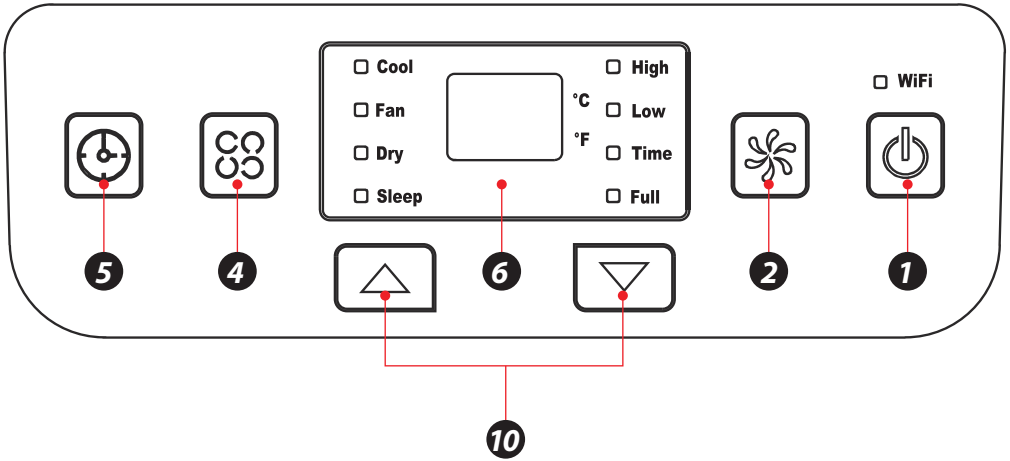

1. Power Button

Press the button for ON/OFF

2. Fan Speed Button

Press the key to choose high/low speed

3. UP/Down Button for Temperature and Timer

Under cooling mode, press the keys could increase or decrease setting temperature; In timer mode, press the keys could set time to turn on. By pressing the keys together, switch between °C and °F can be made.

4. Mode Button

Press the key to choose cooling, fan, dry.

5. Timer Button

Press the key at standby mode would set ON time Press the key at ON mode would set OFF time

6. Temperature and Timer Display

The window will indicate temperature and time.

7. Temperature Switch Button

The button is to switch between °C and °F

8. Sleep button

The button is to choose sleep mode.

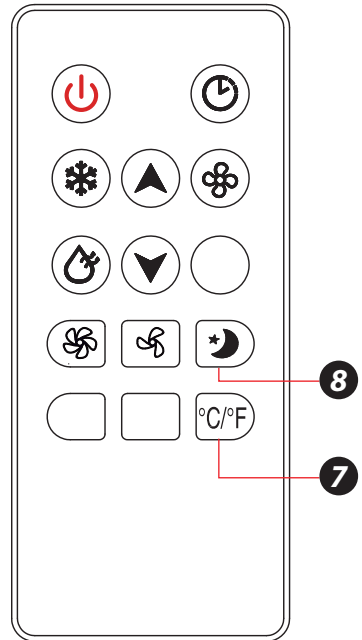

OPERATION

Place & Install

Place

- Place the machine on the horizontal floor near the window.
- For proper ventilation and best machine performance, keep the appliance at least 50cm from objects nearby.

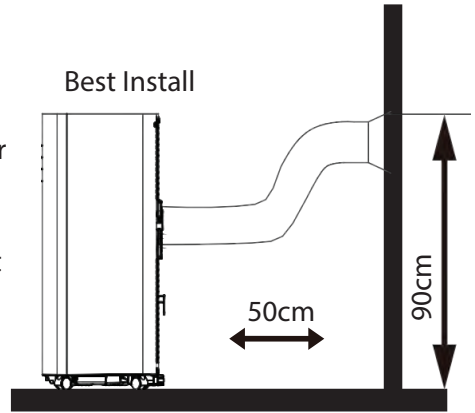

Install

Air Exhaust Duct Assembly

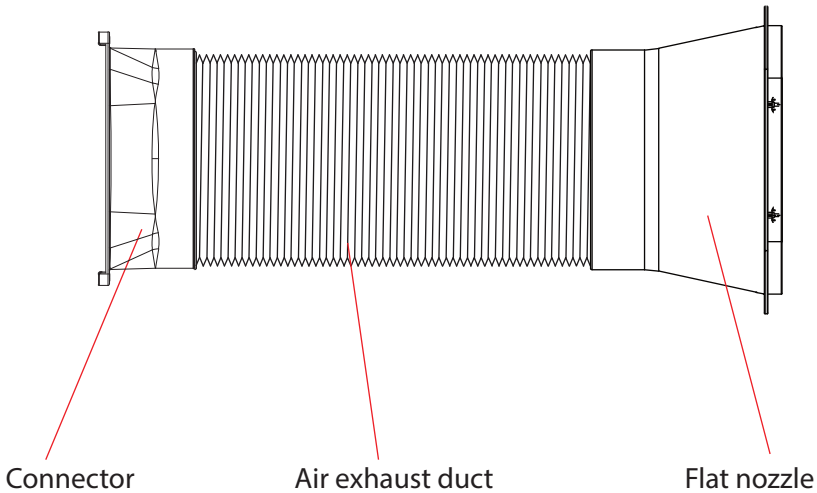

Clip-fixture Type

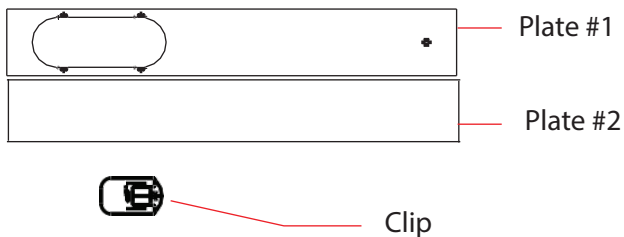

Step 1:

Clip-fixure Type

1. Measure window size;
2. Adjust Length of the plate according to window size;
3. Lock the plate

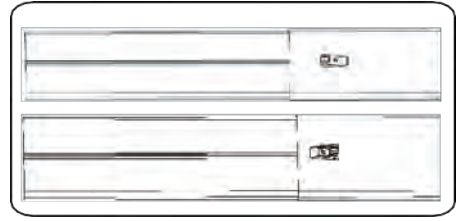

Step 2:

Fix the plate to window

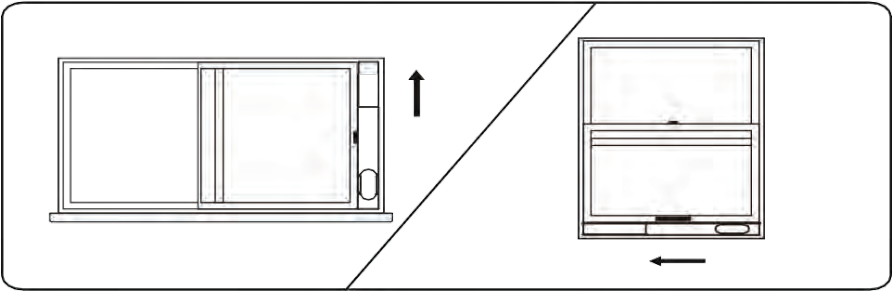

Step 3:

Swirl the exhaust pipe assembly (exhaust fitting end) into the rear panel outlet (counterclockwise).

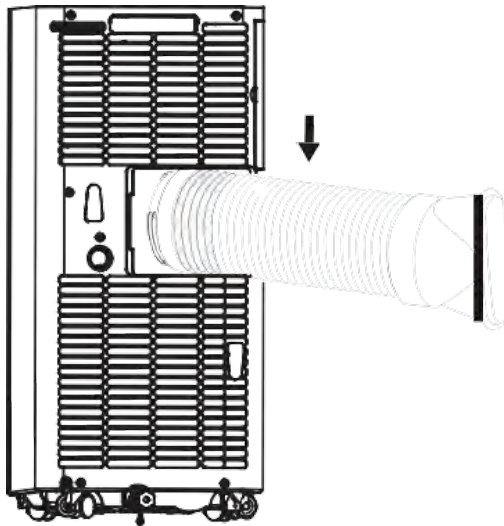

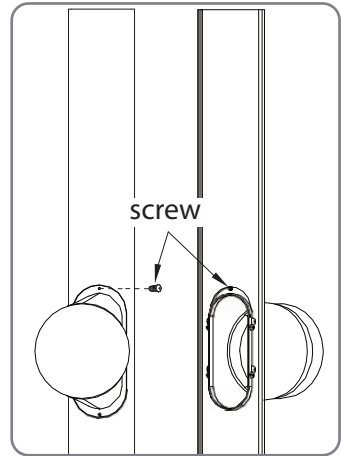
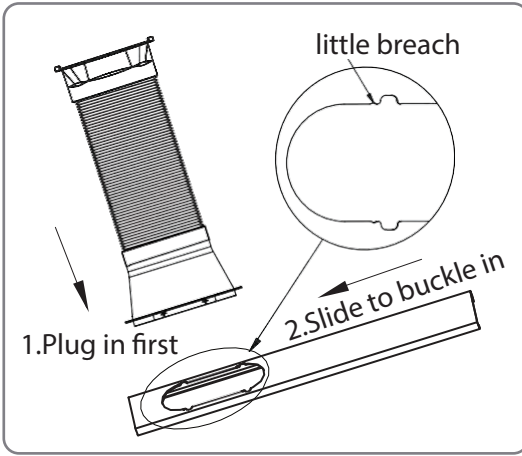

Step 4:

Insert the exhaust pipe assembly (exhaust port end) into the window seal panel assembly and screw it up.

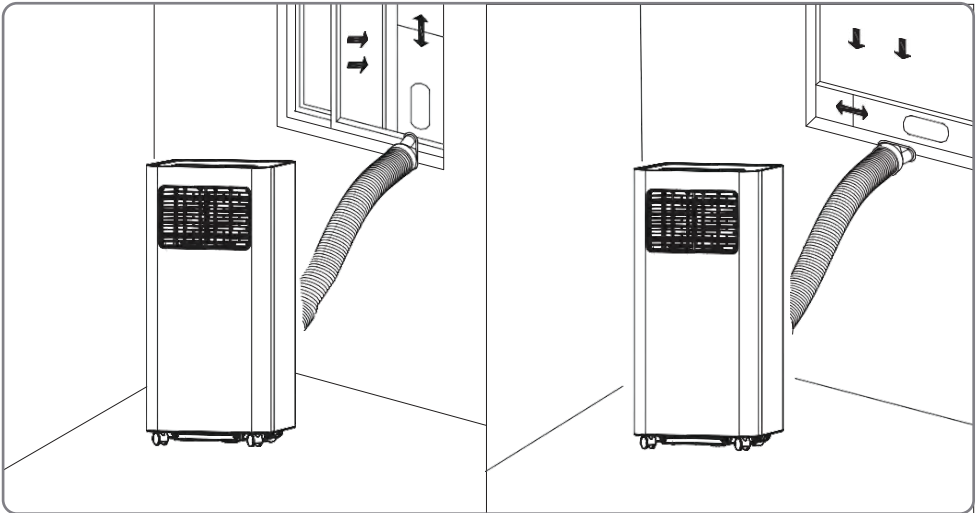

Impression Drawing of Completion

Incorrect installation

- It's important to keep the exhaust duct smooth. Incorrect installation will affect work of the A/C.
- Prevent the exhaust duct from sharp bending.
- Ensure air can flow smoothly in the duct.

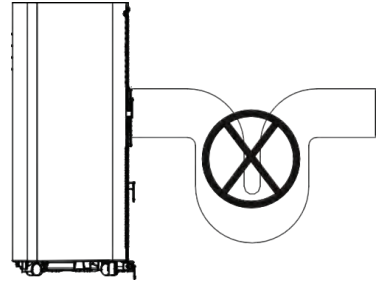

Warning

The exhaust duct is designed especially for this model. Don't replace or lengthen it; otherwise, it will result in failure.

Notice:

The air exhaust duct can stretch up to 1500mm. To avoid bending, stretch it as short as possible

REMOTE CONTROL

Please install the battery correctly before using the remote control.

The specific steps are as follows:

1. Slide to open the battery cover on the back;
2. Insert 2*AAA (DC1.5V) new batteries and install electrodes correctly when inserted;
3. Fit the batteries in place.

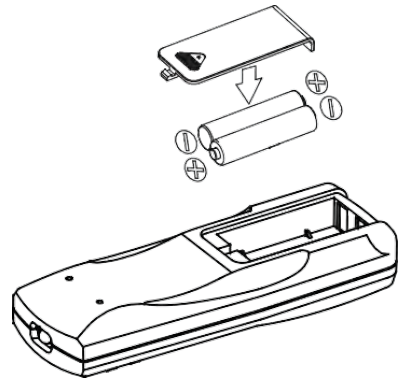

Warning:

1. Only AAA DC 1.5V batteries are allowed, never use chargeable batteries or other types of batteries.
2. Replace both batteries; never mix new battery with old one.
3. Please remove batteries if the appliance is not to be used for a long time.

Warning:

1. Never use leaked batteries;
2. Chemicals in batteries could result in such health hazards as burns. If liquid in batteries splashes to skin or clothes, please wash with clean water in time. If batteries are swallowed, please rinse mouth immediately with clean water and then go to the doctor.



HOW TO OPERATE

Cooling Mode

- Under cooling mode, cooling indicator will light on.
- Temperature Setting is from 60°F to 86°F.
- Press Fan Speed Button to choose from low/high fan speed.

Fan Mode

- Under Fan mode, indicator will be on.
- Press Fan Speed Button to choose from low/high fan speed.
- Temperature cannot be set under this mode.

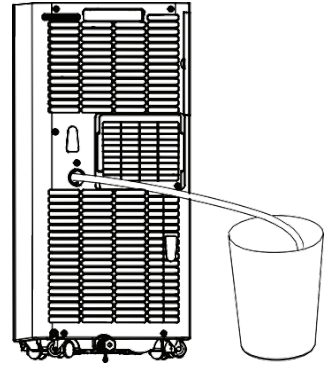

Dry Mode

- Dry indicator will be on under this mode.
- Remove water plug (see right), insert one end of pipe to drainage hose, the other end would be in water tank or water channel.
- If ambient Temp. $\geq 17^{\circ}\text{C}$ or 62°F compressor starts and follow below sequence: if ambient Temp. $\leq 15^{\circ}\text{C}$ or 59°F compressor stops; when it reaches $\geq 17^{\circ}\text{C}$, compressor starts again. (There would be a 3-min delay for compressor protection)
- Fan runs with a fixed low speed.
- Temp. is fixed.

Notes: Under dry mode, please dismantle air exhaust duct, or performance will be affected and water full alarm “FL” will buzz.)

Heating Mode (not available for cooling only model).

- Under this mode, heating indicator will light up.
- Press UP/DOWN button to select Temp. between 16°C to 30°C (60°F to 86°F)
- Press Fan Speed button to set low/high speed.

TIMER MODE

- In standby mode, press Timer button to set ON time. A range of 0 to 24 Hours could be set with UP/DOWN button. Timer indicator will light up in this mode.
- Under running state, press Timer button to set OFF time. A range of 0 to 24Hours could be set with UP/DOWN button. Timer indicator will light up in this mode.

CLEAN AND MAINTENANCE

Drainage

With self-evaporating system, the appliance could perform better and save energy in a way of cooling down condensor by reusing condense water.

The appliance would display “FL” with buzz sound, if built-in water container is full. After compressor stops, please drain water as follows:

1. Unplug and dismantle air exhaust duct;
2. Move the appliance to a right place;
3. Pull out the water plug, and drain all water;
4. Re-insert the water plug;
5. Re-install the air exhaust duct, restart the appliance.

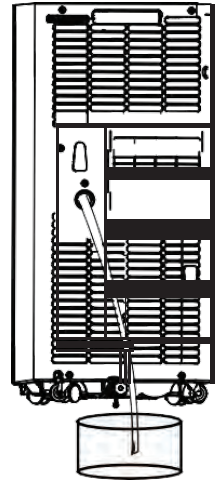

MAINTENANCE

Warning:

In case of electric shock, turn off and unplug before repair or maintenance.

Body Clean

1. Unplug before cleaning.
2. Clean with soft and half-wet cloth.
In case of damage to appearance or the appliance, never use chemical reagent, such as benzene, alcohol and gasoline.
3. Never let splash water enter the appliance.

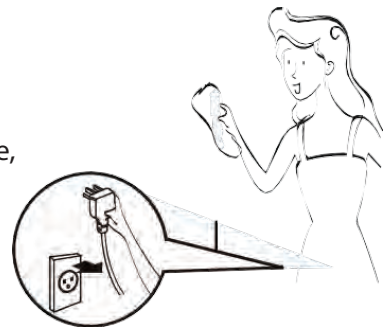

Filter is to be cleaned once every two weeks. If air quality indoor is poor, it has to be washed more often, or performance of the appliance would be lowered due to blocked filter screen. Please follow below instructions for cleaning:

Take off air-inlet grille as indicated in the photo; pull out the filters.

Clean the filter in 40°C or 104°F warm water or water with neutral detergent; dry the filter in a cooling area.

Re-install the filter and grille after drying completed; restart the appliance.

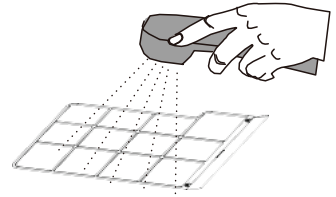
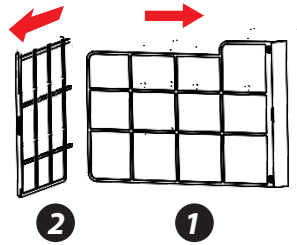
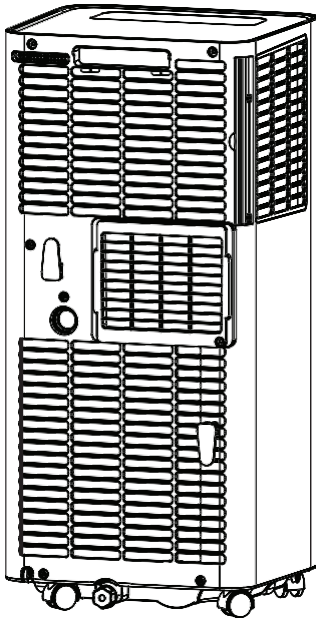

If filter is dirty, clean in 40°C (104°F) warm water or in water with neutral detergent.

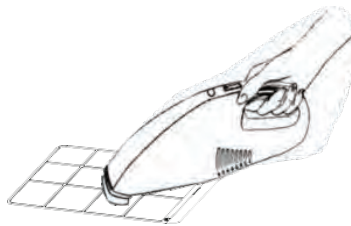

If filter is not that dirty, clean the dust with a vacuum cleaner.

Warning:

Do not wash with filter in water above 40°C (104°F) or with irritating detergent such as alcohol, gasoline and benzene. In case of deformation, filters are to be kept away from heat sources and dried naturally in a cooling area. Never operate the appliance when filter is not installed.

Seasonal Maintenance

If the appliance will not be in use for a long time, please maintain by following below steps:

1. Pull out water plug for drainage.
2. Run in Fan mode for at least 2 hours to dry internal parts.
3. Turn off and unplug.
4. Clean the filter and reinstall.
5. Dismantle the air exhaust duct and keep it well.
6. Take off batteries.
7. Wrap the appliance in a plastic bag and keep in a dry and cooling place

If the appliance haven't been used for a long time, please pay attention to the following when to be used again:

1. Make sure water plug and filter are installed.
2. Never use damaged power cord; Check before use.
3. Insert batteries.
4. Assemble other parts according to the instruction.



COMMON FAILURES AND DIAGNOSIS

Intelligent Error Detection

Error-detecting code	Multi-functional deflection
E1	Error of the coil's temperature sensor
E2	Error of indoor temperature sensor
E4	Anti-freezing protection: temperature of the coil is too low and the whole A/C is off. When temperature excesses 8°C (46.4°F), the protection is released and previous working state is recovered.

TROUBLESHOOTING

The following table lists the common faults and maintenance methods of this series of portable A/C. When the machine is in abnormal operation, the following table can be used for simple diagnosis and maintenance. If it still can't be solved, please contact professional maintenance personnel.

TROUBLE	CAUSE	SOLUTION
The A/C doesn't work	No display	Reset circuit breaker on AC cord
	The display panel displays "FL"	Restart the A/C after power off and draining, then it will become normal
	Time OFF function is started	The A/C can be restarted 3 minutes after being turning off
The A/C starts frequently	Direct sunlight	Draw the curtain
	Doors and windows keep open; there are lots of people or heat source in room	Close doors and windows, remove heat source
	Filter screen is very dirty	Clean or replace it
	Air inlet or air outlet is blocked	Remove the stem
Loud noise on the A/C	The A/C is placed unevenly	Place it at even and firmground, avoid shaking
The compressor doesn't work	Its delay protection started	Wait for 3min, turn on after temperature decreases

FEATURES:

- Metal Control Box to Prevent from Fire and Exploding
- Rotary Compressor
- Universal Castors for Moving Freely
- Wifi function
- Lightweight & Portable A/C Unit
- Compact Freestanding Room Air Conditioner
- (3) Operation Modes: AC Cooling/Dehumidifier/Fan
- Hassle-Free, Quick Setup Cooling
- Simple Electric Plug-in Operation
- Convenient Wide-Area Climate Control Room AC Coverage
- Push Button Control Panel with LED Display
- Time, Temperature & Fan Speed Adjustment Settings
- Includes Universal Window Mount AC Exhaust Kit
- Removable & Washable Air Filter Screen
- Modern Style, Sleek Body Housing
- Energy Efficient: Low Power Consumption
- Low Noise Level Motor
- Rolling Wheels for Easy Portability
- Used for Home, Office, School & Business Rooms

WHAT'S IN THE BOX:

- AC Unit
- Exhaust Hose
- Window Installation Plate
- Remote Control

TECHNICAL SPECS:

- Power Supply: 115V/60Hz
- Rated Power: 920W
- Refrigerant Type: R410a
- Cooling capacity (ASHRAE): 10,000 Btu/h
- Cooling capacity (DOE): 5,500 Btu/h
- Coverage Area: Cools Rooms up to 300 Square Feet
- Air Flow: 360 Cubic Meters / Hour
- Operating Modes: Cool / Fan / Dry (Dehumidifier)
- Moisture Removal / Dehumidifier: 1.2 Liters / Hour
- Operating Noise Level: 57 dBA
- Fan Speed Settings: Two Level, Low/High
- Temperature Unit Selectable: °C/°F (Celsius/Fahrenheit)
- Adjustable Timer Settings: Up to 24 Hours
- Construction Material: High Impact Polystyrene (HIPS)
- Battery Operated Remote Control, Requires (2) x 'AAA' Batteries, Included
- Power Cable Length: 5.6' ft.
- Product Dimension (L x W x H): 27.6" x 12.8" x 11.6" -inches



WARNING:

This product can expose you to a chemical or group of chemicals, which may include "**Acrylonitrile**" which is known in the state of California to cause cancer, birth defects, or other reproductive harm. For more info, go to <https://www.p65warnings.ca.gov/>.



SereneLife

Questions? Issues?

We are here to help!

Phone: (1) 718-535-1800

Email: support@pyleusa.com

