

For Assistance Call: **1-800-522-7336**  
 8 am - 5 pm, Monday - Friday, MST  
 or visit our Website at:  
[www.nostalgicwarehouse.com](http://www.nostalgicwarehouse.com)

## Installation Instructions Interior Passage Sets

Unwrap all components, laying them within easy reach. You will need a screwdriver, ruler, and nail polish or threadlock.

### Door Preparation:

(If door is pre-drilled, skip this step) Choose a location for the door-knob to install, approx. 36"-38" from the floor, or centered in a pleasing location. Using a hole saw, drill a 2 1/8" hole through the door, with a centered backset of 2 3/8". Edge bore a 1" hole into the door, approximately 3 3/4" deep, centered as shown. Insert latch into the bored hole and, keeping it perpendicular to the floor, use a sharp awl or razor knife to scribe a line around faceplate. Remove the latch and use a chisel to cut an approx. 3/16" deep mortise, so that the latch face will lie flush with the door edge.

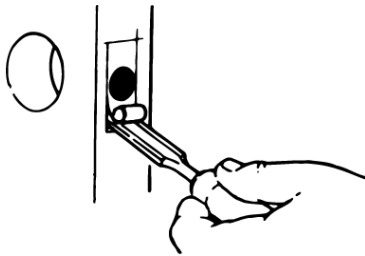

### Install the Latch:

Install latch into the door with the rounded part of the latch tongue facing the door jamb. Tighten screws securely.

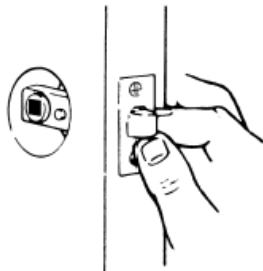

### FOR LONGPLATES:

Gently back the set screws out of each doorknob approx. 1/2 way, or until they do not protrude through the spindle hole. To be sure that the spindle is centered in the latch, unscrew one knob approx. 1/4" - 1/2", depending on the thickness of door. Remove the other knob completely.

You should now have one doorknob still on the spindle and one loose doorknob. Holding the knob which is on the spindle, slip the spindle through one of the door plates and guide the spindle through the square hole in the door latch. Slide the other door plate onto the pro-

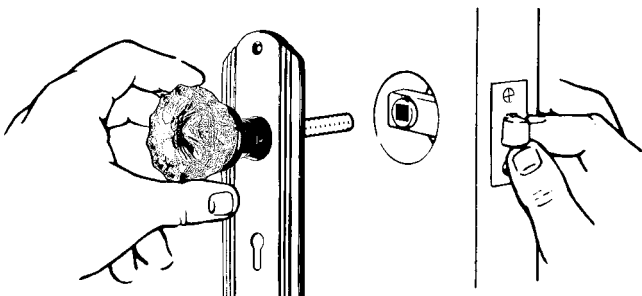

truding spindle and screw the remaining knob onto the spindle, snugly to hold plates in place.

Use a ruler to make sure that the plates are parallel to the edge of the door. Give the knobs a bit of a wiggle to align them and keep them from binding against the plates. Screw the top screw(s) into one door plate, then the bottom screw(s), and again check your alignment. Follow with the plate on the other side. Now, unscrew the doorknobs about 1/2 turn or just until they turn freely. If all is still aligned and the knobs turn easily, screw in any remaining wood screws.

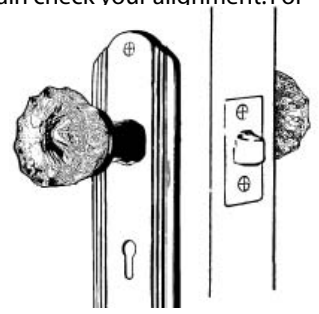

### FOR ROUNDPLATES:

We have provided two lengths of machine screws to mate the backplates. Choose the shorter machine screws for 1 3/8" thick doors or the longer screws for 1 3/4" thick doors. If you need a different length than those provided, call 1-800-522-7336 for technical assistance.

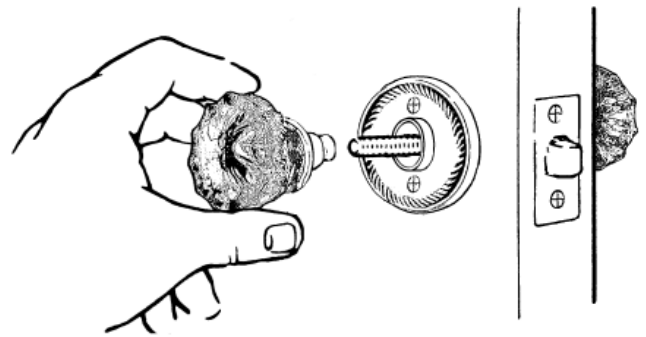

Loosen set screws and remove both doorknobs from the spindle. Center the spindle in door latch. Slide the threaded backplate over the spindle on the outside (most visible) side of the door. Slide its mate (with screwholes) onto the other side. Screw the backplates together, snugly but not too tight. Screw one doorknob onto the spindle, keeping the spindle centered. Now screw on the second knob, bringing it up snugly, allowing the backplates to align themselves. Tighten the backplate screws. Now, unscrew the doorknobs about 1/2 turn or just until they turn freely.

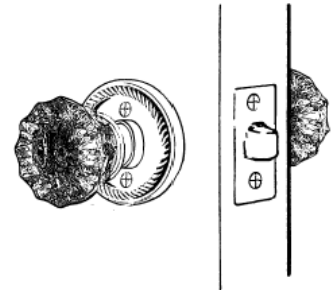

### Finishing the Knob Installation:

Screw in all set screws carefully, making sure that they tighten against the flat part of the spindle (a slight wiggle can help to set them in place). Try the doorset, making sure that everything works smoothly. Lastly, remove each set screw, one at a time, and coat threads with fingernail polish or threadlock. Replace each.

### Installing the Strike:

Placing the strike in the correct position is very important for proper doorset function. Using a small piece of carbon paper, close the door so that the latch rubs the black carbon onto the door jamb. Repeat until a black smear is clearly visible, showing the path of the latch tongue. Center the strike over the black mark. Mortise for strike similarly to the procedure used for the latch face. Use a drill to cut the hole for the latch tongue. Install strike.

## Interior Privacy Sets (split spindle)

Unwrap all components, laying them within easy reach. You will need a screwdriver, ruler, and nail polish or threadlock.

Prepare door and install strike as shown on reverse page, under Door Preparation. Install the privacy latch with the privacy button hole towards the side of the door that you wish to lock. The tongue of the latch should be facing the door jamb side of the door. If it is not, call 1-800-522-7336 for technical assistance.

### Prepare the Knobs:

If the doorknobs are on a solid spindle, remove this spindle and discard it. You will only be using the split spindle for this installation. You may need to back the set screws out of each doorknob approx. 1/2 way.

### Placement of the Spindle:

Tighten the split spindle gently, but snugly. Then unscrew one half of the spindle 2 full turns, leaving a gap of approx. 1/8". Insert the spindle into the latch, with the stop-pin on the non-locking side of the door.

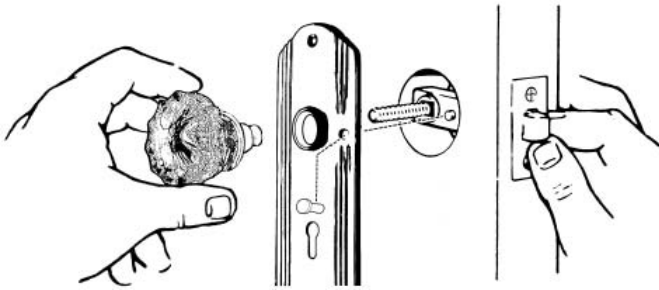

### FOR LONGPLATES:

Be sure that the privacy holes are closest to the edge of door. Slide one door plate onto the side of the spindle without the stop pin. Screw on one of the door knobs until it rests loosely against the door plate (do not tighten as it will pull the latch out of alignment). Slide the other door plate onto the protruding spindle (the side with the stop pin) and screw the remaining knob onto the spindle, snugly to hold plates in place. Check to see that the privacy mechanism lines up with the holes on the plates. If it does not, back up a few steps and try again. Screw the privacy button through the plate on the locking side and into the latch.

Use a ruler to be sure that everything is straight. Give the knobs a bit of a wiggle to align them and keep them from binding against the plates. Screw the top screw(s) into one door plate, then the bottom screw(s), and again check your alignment. Follow with the plate on the other side. Now, unscrew the knobs about 1/2 turn or just until they turn freely. If all is still aligned and the door knobs turn easily, screw in any remaining wood screws. See Finishing the Knob Installation in next column.

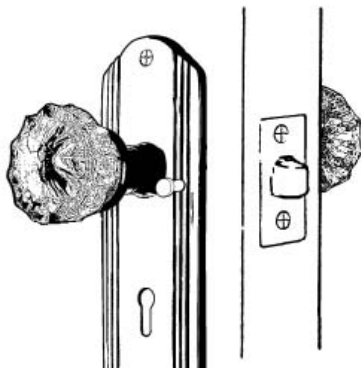

### FOR ROUNDPLATES:

We have provided two lengths of machine screws to mate the backplates. Choose the shorter machine screws for 1 3/8" thick doors or the longer screws for 1 3/4" thick doors. If you have any trouble tightening the plates together, give us a call at the number on reverse side.

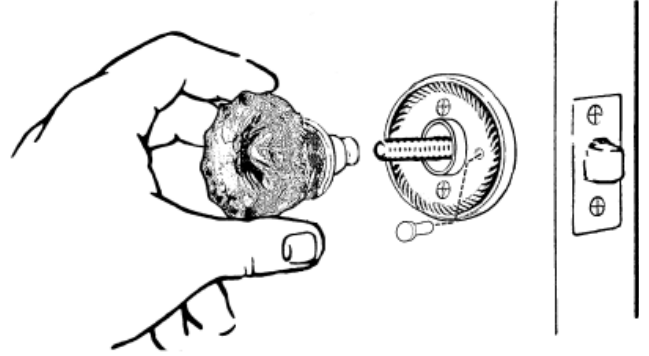

Slide the threaded backplate over the spindle on the non-locking side of the door. Slide its mate (with screwholes) onto the other side. The privacy holes should be closest to the latch side of door. Screw the backplates together, snugly but not too tight. Screw the first doorknob onto the spindle on the locking side of the door. Now screw on the second knob, bringing it up snugly, allowing the plates to align themselves. Screw the privacy button through the plate on the locking side and into the latch. Tighten the backplate screws. Now, unscrew the knobs about 1/2 turn or just until they turn freely.

### Finishing the Knob Installation:

Next, tighten all set screws, making sure that they are straight against the flat part of the spindle (a slight wiggle can help to set them in place). Try the doorset, making sure that everything works smoothly. Lastly, remove each set screw and coat their threads with fingernail polish or threadlock. Replace each.

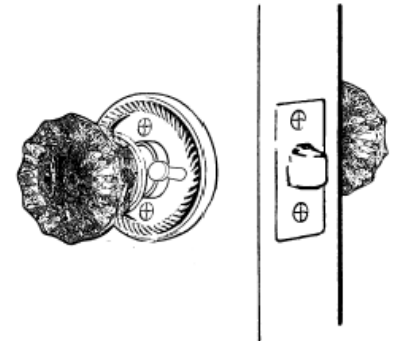

### Using the Doorlock:

To lock the door, push in the privacy button. To unlock the door, simply turn the inside doorknob. To gain emergency access from the non-locking side of the door... insert a small, blunt instrument (the enclosed Allen wrench works well) into the emergency hole located next to the doorknob. Pushing gently will disengage lock.

## Single Dummy (For individual mounting)

Mount the steel dummy backplate to the door with dummy spindle protruding through the center hole. Place the brass backplate over the protruding spindle. Screw the doorknob onto the spindle, tightening into place. Align and tighten the allen set screws to lay flat against the dummy spindle.

## Double Dummy (For back-to-back mounting)

Option 1: Install as 2 single dummies as shown above.

Option 2: Drill hole through door approx. 1/2" in diameter. Place long spindle through hole. Place the brass backplates over the protruding spindle ends. Screw the doorknobs onto the spindle, tightening into place. Align and tighten the allen set screws to lay flat against the spindle.

# NOSTALGIC

WAREHOUSE™



For  
Assistance  
Call:

1-800-522-7336  
8 am - 5 pm, Monday - Friday, MST

or visit our Website at:  
[www.nostalgicwarehouse.com](http://www.nostalgicwarehouse.com)

## Updates to Installation Instructions

### Update #1 Improved Latch Instructions

Nostalgic Warehouse has improved its latch to facilitate installation and to make our products more robust. The latch installs into the door in the same manner as our previous latch, however you must rotate the latch tongue and install the faceplate in order to secure the latch in place.

The following steps are now applicable to the "Install the Latch" section of the Installation Instructions for Interior Passage & Privacy Sets.

**Step 1:** Insert the latch into the door.

**Step 2:** Rotate the latch tongue so that the flat edge faces away from the door jamb and the curved edge is oriented towards the door jamb.

**Step 3:** Mount the faceplate over the latch tongue (see image below) and secure it to the door with two 1" wood screws.

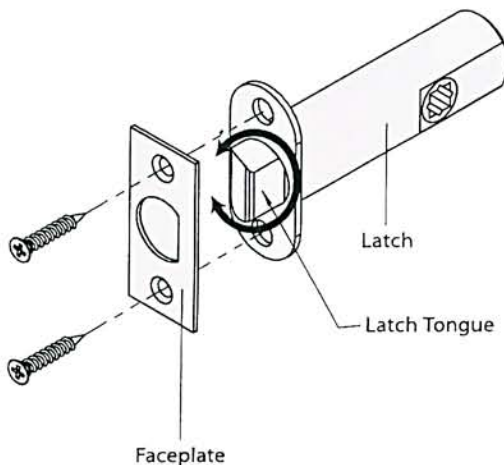

### Update #2 Improved Knob Installation Instructions

Nostalgic Warehouse has improved its knobs with the addition of two nylon "washers" to make installation easier and operation smoother over the life of the doorset.

The following steps are applicable to the "For Long Plates" and "For Round Plates" sections of the Installation Instructions for Interior Passage & Privacy Sets.

**Step 1:** Install one nylon washer onto the spindle so that the wide side will nest against the base of the knob. Then, thread on the knob. See image below.

**Step 2:** Install the first knob as described in the installation instructions.

**Step 3:** Install the second nylon washer onto the spindle on the opposite side of the door, again so that the wide side will nest against the base of the knob. Then, thread on the second knob.

Note: On crystal and porcelain knobs, the washer will be visible after installation. On brass knobs, the washer will not be visible after installation.

