

### Features

- Integral apron.
- Safeguard® slip-resistant surface on bath floor.
- Left-hand drain.
- Coordinates with other products in the Memoirs collection.

### Material

- KOHLER® enameled cast iron.

### Installation

- Three-wall alcove.

### Additional Hydrotherapy Options

- Soaking Bath - 721-0
- BubbleMassage air bath - 723-G0
- Whirlpool - 723-H2

### Recommended Products/Accessories

K-7161-AF Bath Drain  
K-1491 Bath/Whirlpool Pillow  
K-1601 Bath/Whirlpool Footstop  
K-7259 Clearflo Bath Drain  
K-702200-G54 Frameless Sliding Bath Door  
K-702200-G73 Frameless Sliding Bath Door  
K-702200-L Frameless Sliding Bath Door  
K-702205-L Frameless Sliding Bath Door  
K-706000-D3 Frameless Sliding Bath Door  
K-706000-L Frameless Sliding Bath Door  
K-706003-L Frameless Sliding Bath Door  
K-706004-D3 Frameless Sliding Bath Door  
K-706004-L Frameless Sliding Bath Door  
K-706007-L Frameless Sliding Bath Door



ADA

### Codes/Standards







ASME A112.19.1/CSA B45.2  
ASTM F462  
ADA  
ICC/ANSI A117.1

### KOHLER® Enameled Cast Iron Bath and Shower Base Lifetime Limited Warranty

See website for detailed warranty information.

### Available Colors/Finishes

*Color tiles intended for reference only.*

Color	Code	Description
	0	White
	96	Biscuit
	47	Almond
	NY	Dune
	55	Innocent Blush™
	G9	Sandbar

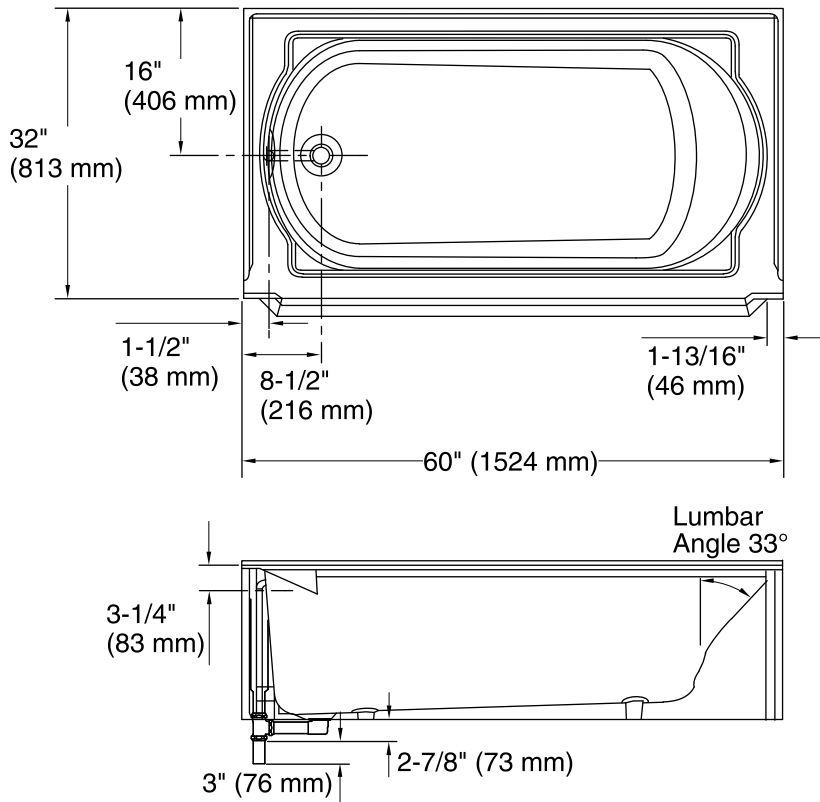

No change in measurements if connected with drain illustrated. (K-7161-AF)

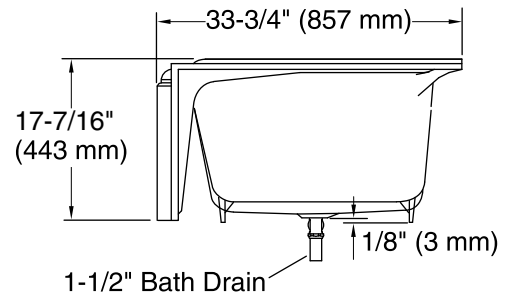

### Technical Information

All product dimensions are nominal.

Installation:	Three-wall alcove
Drain location:	Left
Basin area, bottom:	45" x 23" (1143 mm x 584 mm)
Basin area, top:	54" x 25" (1372 mm x 635 mm)
Weight:	390 lbs (176.9 kg)
Minimum floor load:	61 lbs/ft <sup>2</sup> (297.8 kg/m <sup>2</sup> )
Water depth:	11-5/8" (295 mm)
Water capacity:	52 gal (196.8 L)
Minimum flat for door:	2" (51 mm)

### Notes

Measure your actual product for rough-in details. Install this product according to the installation instructions.

The hot water supply should be 70% of the capacity of the bath or greater. Installations will vary.

ADA compliant when installed to the specific requirements of these regulations.