







# Assembly Instruction

DQ632L

| NO. | PART LIST   | DESCRIPTION      | Q/TY<br>PCS |
|-----|---|------------------|-------------|
| A   |    | LEFT<br>ARMREST  | 1PC         |
| B   |    | RIGHT<br>ARMREST | 1PC         |
| C   |    | BACK             | 1PC         |
| D   |    | SEAT             | 1PC         |
| AA  |    | BOLT<br>M6X15    | 2PCS        |
| BB  |   | BOLT<br>M6X30    | 8PCS        |
| CC  |  | HEX<br>WRENCH    |             |

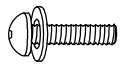

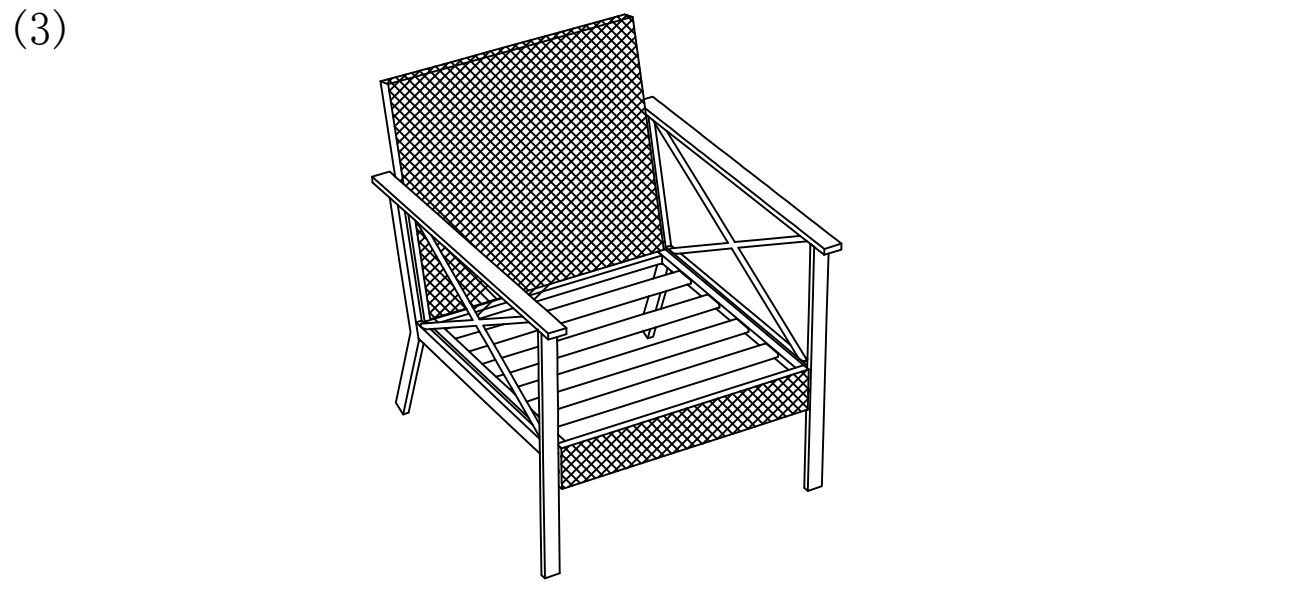
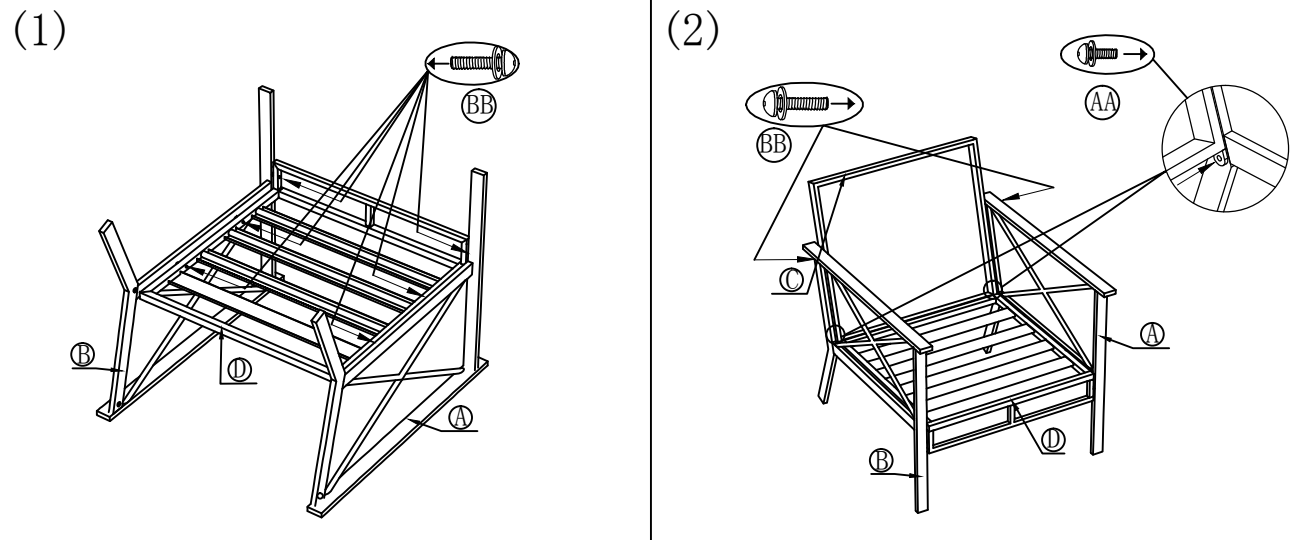
Note:do not tighten bolts until all parts are connected