

10' W x 8' H or 10' H Round Style Shelter Assembly Instructions

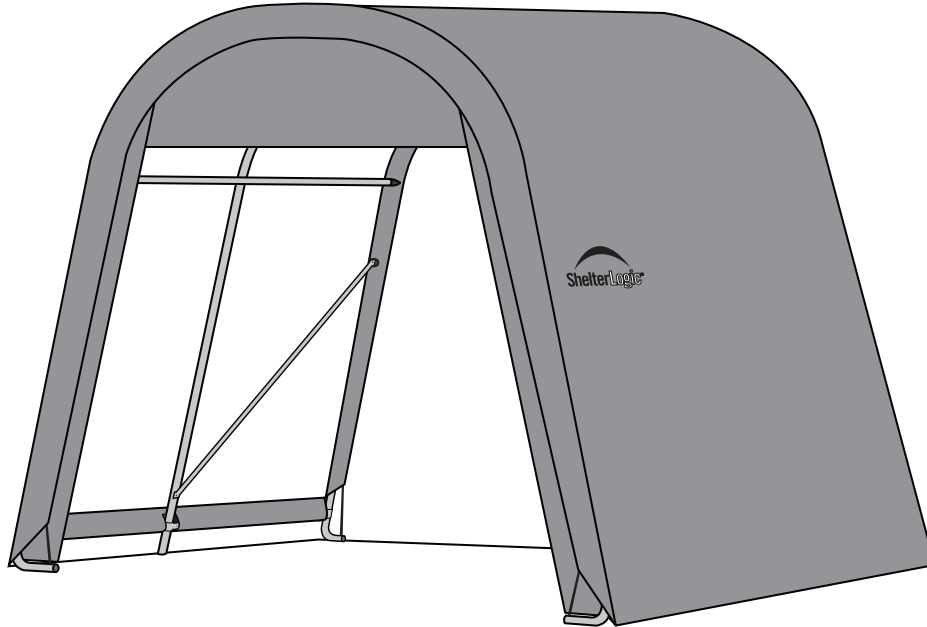

DESCRIPTION

10' x 8' x 8' Round Style Shelter - Gray

10' x 8' x 10' Round Style Shelter - Gray

RECOMMENDED TOOLS

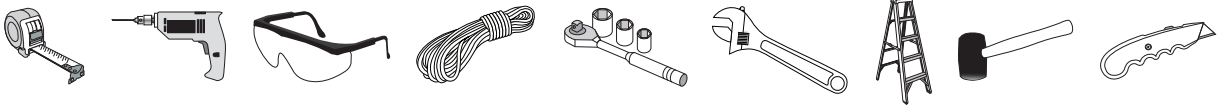

Please read instructions **COMPLETELY** before assembly. This shelter **MUST** be securely anchored. **THIS IS A TEMPORARY STRUCTURE AND NOT RECOMMENDED AS A PERMANENT STRUCTURE.**

Before you start: 2+ individual recommended for assembly, approximate time 3 hr.



150 Callender Road
Watertown, CT 06795
www.shelterlogic.com

1-800-524-9970

Canada:
1-800-559-6175

ATTENTION:

This shelter product is manufactured with quality materials. It is designed to fit the **ShelterLogic®**, LLC custom fabric cover included. **ShelterLogic®**, LLC Shelters offer storage and protection from damage caused by sun, light rain, tree sap, animal - bird excrement and light snow. Please anchor this **ShelterLogic®**, LLC structure properly. See manual for more anchoring details. Proper anchoring, keeping cover tight and free of snow and debris is the responsibility of the consumer. Please read and understand the installation detail, warnings and cautions prior to beginning installation. If you have any questions call the customer service number listed below. Please refer to the warranty card inside this package.

DANGER:

Prior to installation, consult with all local municipal codes regarding installation of temporary shelters. Choose the location of your shelter carefully. **DANGER: Keep away from electrical wires.** Check for overhead utility lines, tree branches or other structures. Check for underground pipes or wires before you dig. DO NOT install near roof lines or other structures that could shed snow, ice or excessive run off onto your shelter. DO NOT hang objects from the roof or support cables.

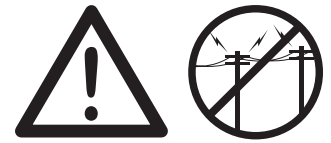

WARNING:

Risk of fire. DO NOT smoke or use open flame devices (including grills, fire pits, deep fryers, smokers or lanterns) in or around the shelter. DO NOT store flammable liquids (gasoline, kerosene, propane, etc.) in or around your shelter. Do not expose top or sides of the shelter to open fire or other flame source.



CAUTION:

Use **CAUTION** when erecting the frame. Use safety goggles during installation. Secure and bolt together overhead poles during assembly. Beware of pole ends.

PROPER ANCHORING AND INSTALLATION OF FRAME:

PROPER ANCHORING OF THE FRAME IS THE RESPONSIBILITY OF THE CONSUMER.

ShelterLogic®, LLC is not responsible for damage to the unit or the contents from acts of nature. Any shelter that is not anchored securely has the potential to fly away causing damage, and is not covered under the warranty. Periodically check the anchors to ensure stability of shelter. The preferred anchoring system includes the use of bolted cement wedge lags for the frame. **ShelterLogic®**, LLC cannot be responsible for any shelter that blows away. **NOTE:** *Your shelter's cover can be quickly removed and stored prior to severe weather conditions.* If strong winds or severe weather is forecast in your area, we recommend removal of cover. Check with your insurance carrier for any damage as you would for any other outdoor structure or personal property claims.

REPLACEMENT PARTS, ASSEMBLY, SPECIAL ORDERS:

Genuine **ShelterLogic®**, LLC replacement parts and accessories are available from the factory, including anchoring kits for nearly any application, replacement covers, wall and enclosure kits, vent and light kits, frame parts, zippered doors and other accessories. All items are shipped factory direct to your door.

QUESTIONS - CLAIMS - SPECIAL ORDERS? CALL OUR CUSTOMER SERVICE HOTLINE:

U.S. CUSTOMER SERVICE: 1-800-524-9970 INTERNATIONAL CUSTOMER SERVICE: 001-860-945-6442 CANADA CUSTOMER SERVICE: 1-800-559-6175

HOURS OF OPERATION: MON-FRI 8:30AM-8:00PM EST, SAT-SUN 8:30AM-5:00PM EST.

CARE AND CLEANING:

A tight cover ensures longer life and performance. Always maintain a tight cover. Loose fabric can accelerate deterioration of cover fabric. Immediately remove any accumulated snow or ice from the roof structure with a broom, mop or other soft-sided instrument. Use extreme caution when removing snow from cover- always remove from outside the structure. DO NOT use hard-edged tools or instruments like rakes or shovels to remove snow. This could result in punctures to the cover. DO NOT use bleach or harsh abrasive products to clean the fabric cover. Cover is easily cleaned with mild soap and water.

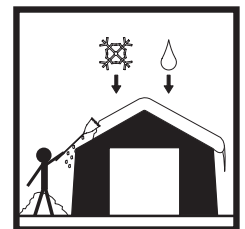

WARRANTY:

This shelter carries a full limited warranty against defects in workmanship. **ShelterLogic®**, LLC warrants to the Original Purchaser that if properly used and installed, the product and all associated parts, are free from manufacturer's defects for a period of:

1 YEAR FOR COVER FABRIC, END PANELS AND FRAMEWORK

Warranty period is determined by date of shipment from **ShelterLogic®**, LLC for factory direct purchases or date of purchase from an authorized reseller, (please save a copy of your purchase receipt). If this product or any associated parts are found to be defective or missing at the time of receipt, **ShelterLogic®**, LLC will repair or replace, at it's option, the defective parts at no charge to the original purchaser. Replacement parts or repaired parts shall be covered for the remainder of the Original Limited Warranty Period. All shipping costs will be the responsibility of the customer. Parts and replacements will be sent C.O.D. You must save the original packaging materials for shipment back. If you purchased from a local dealer, all claims must have a copy of original receipt. Check with your insurance carrier for any damage as you would for any other outdoor structure or personal property claim. After purchase, please fill out and return warranty card for product registration. Please see warranty card for more details.

Covered by U.S. Patents and patents pending: 6,871,614; 6,994,099; 7,296,584; D 430,306; D 415,571; D 414,564; D 409,310; D 415,572

10'W x 8'H Round Style Frame Assembly

Please read and understand instructions completely before assembly.

Layout out frame parts as shown.

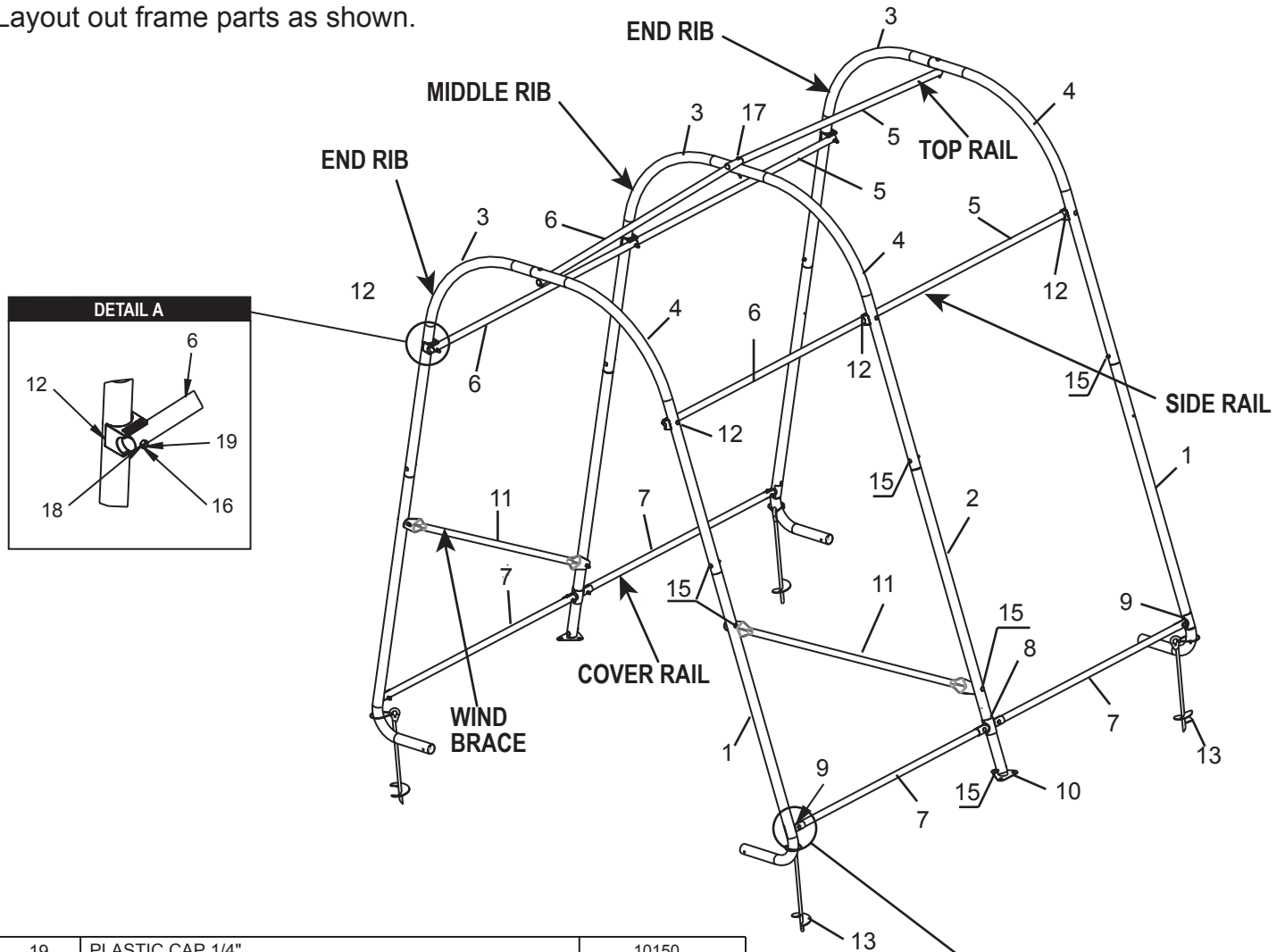

19	PLASTIC CAP 1/4"	10150
18	NUT, HEX, 1/4-20	01010
17	BOLT, LADDER RD,F/TOPCRESTS,1/4"X3"L	802630
16	BOLT, CARRIAGE 1/4" X 3"	10210
15	BOLT, CARRIAGE 1/4"x2"	10114
14	BOLT, CARRIAGE,1/4"x1-5/8"	10115
13	ANCHOR, AUGER 3"X15" WITH CABLE & CLAMP	00847
12	SHELTERLOCK ANTI-RACK DEVICE 42X28MM	800260
11	WIND BRACE 57", FLAT BOTH ENDS 55 1/2C2C	10205
10	FOOT PLATES 1-3/8" DIA.	10270
9	3-WAY COVER RAIL CLAMP 1 5/8" PIPE	10112
8	4-WAY COVER RAIL CLAMP	10111
7	CROSS RAIL PLAIN ENDS 45 3/4"L, 2 HOLES	10110
6	CROSS RAIL 48-1/2"x1.163",PLAIN ENDS 2 H	02031
5	CROSS RAIL 50-1/2"x1.163", 1 SWDGD 2 HOLE	02030
4	SIDE BEND PLAIN 74" X 1-5/8" DIA.	800469
3	SIDE BEND SWDGD ONE SIDE, 74" X 1-5/8" DIA.	800468
2	UPRIGHT 56"x1-5/8" DIA.	10273
1	UPRIGHT W/LEG SWGD ONE SIDE, 63"x1-5/8"	10226
ITEM NO	DESCRIPTION	PART NO.

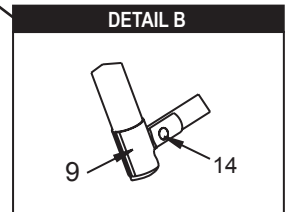

ATTENTION:
FOR MISSING OR
REPLACEMENT PARTS
OR QUESTIONS, PLEASE
CONTACT
CUSTOMER SERVICE:
1.800.524.9970
CANADA 1.800.559.6175

10'W x 10'H Round Style Frame Assembly

Please read and understand instructions completely before assembly.

Layout out frame parts as shown.

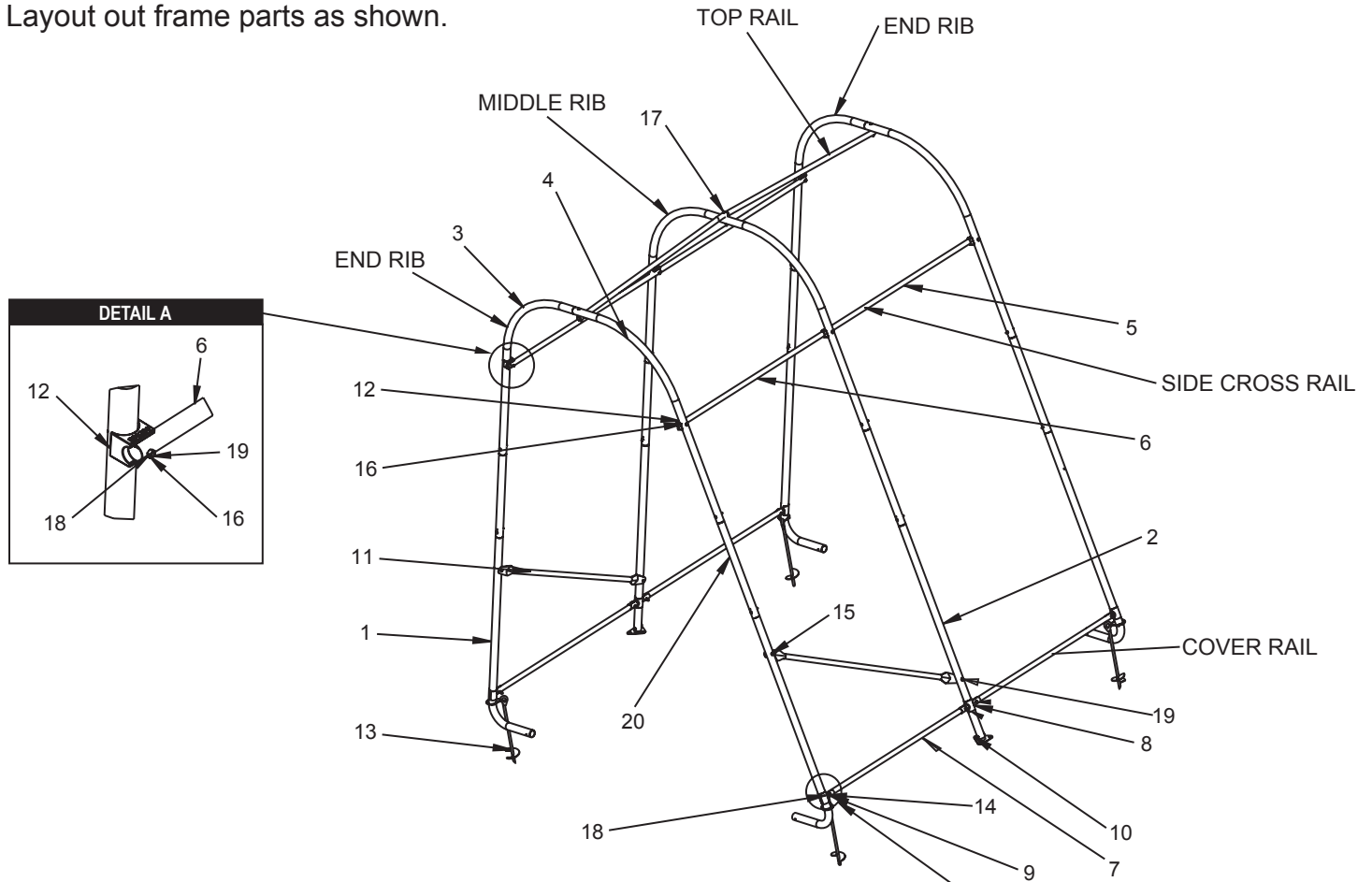

20	UPRIGHT EXTENSION, 27" SWGD 1SIDE, 1 5/8D	10223
19	PLASTIC CAP 1/4"	10150
18	NUT, HEX, 1/4-20	01010
17	BOLT, LADDER RD,F/TOPCRESTS, 1/4"X3 1/2"L	802630
16	BOLT, CARRIAGE 1/4" X 3"	10210
15	BOLT, CARRIAGE 1/4"x2"	10114
14	BOLT, CARRIAGE, 1/4"X1-5/8"	10115
13	ANCHOR, AUGER 3"X15" WITH CABLE & CLAMP	00847
12	SHELTERLOCK ANTI-RACK DEVICE 42X28MM	800260
11	WIND BRACE 57", FLAT BOTH ENDS 55 1/2C2C	10205
10	FOOT PLATES 1-3/8" DIA.	10270
9	3-WAY COVER RAIL CLAMP 1 5/8" PIPE	10112
8	4-WAY COVER RAIL CLAMP	10111
7	CROSS RAIL PLAIN ENDS 45 3/4"L, 2 HOLES	10110
6	CROSS RAIL 48-1/2"X1.163", PLAIN ENDS 2 H	02031
5	CROSS RAIL 50-1/2"X1.163", 1 SWDG 2 HOLE	02030
4	SIDE BEND PLAIN 74"X1-5/8"DIA.	800469
3	SIDE BEND SWDG ONE SIDE, 74"X1-5/8" DIA.	800468
2	UPRIGHT 56"X1-5/8" DIA.	10273
1	UPRIGHT W/LEG SWGD ONE SIDE, 63"X1-5/8"	10226
ITEM NO	DESCRIPTION	PART NO.

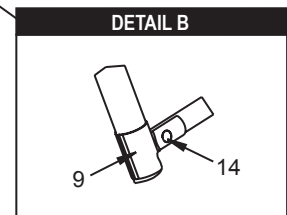

ATTENTION:
FOR MISSING OR
REPLACEMENT PARTS
OR QUESTIONS, PLEASE
CONTACT
CUSTOMER SERVICE:
1.800.524.9970
CANADA 1.800.559.6175

ASSEMBLY OF PEAK STYLE GARAGE SHELTER

NOTE FOR FRAME EXTENSION KIT: 10' x 8' is the base frame dimension. Your model may have more middle ribs than shown in the illustrations. You will receive one extra rib for every extra 4 feet of building length that you purchase. The basic frame assembly will remain the same. The cover will be the correct size for the length of the building ordered.

1. PLOTTING AND SQUARING UP THE FRAME:

- A. Before building your shelter, you should choose a flat area on your property and plot your shelter. Stake out the area for the frame in the desired spot. Check that it measures 10' in width and the length would be determined by the size shelter you purchased. Tie a rope diagonally from corner to corner.
- B. Measure across area, end to opposite end. See Detail A. The measurement A and B should be equal.

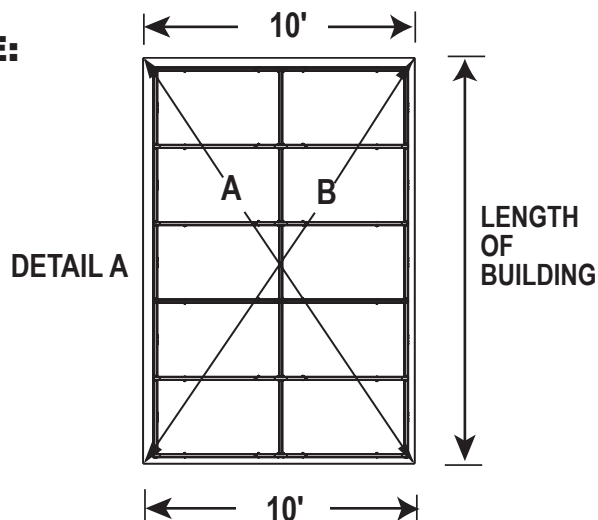

2. ASSEMBLE END AND MIDDLE RIBS:

- A. Assemble end and middle ribs as shown in Detail B and Detail C. Securely fasten all of the joints with the hardware indicated.

8' HIGH

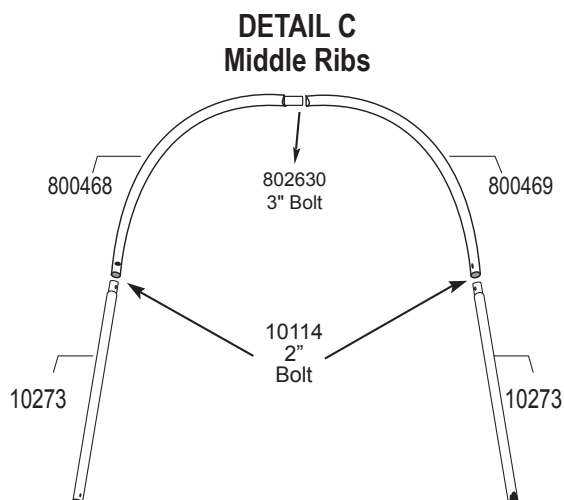
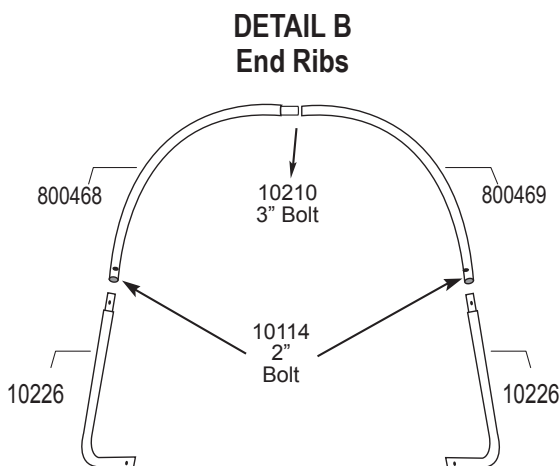

10' HIGH

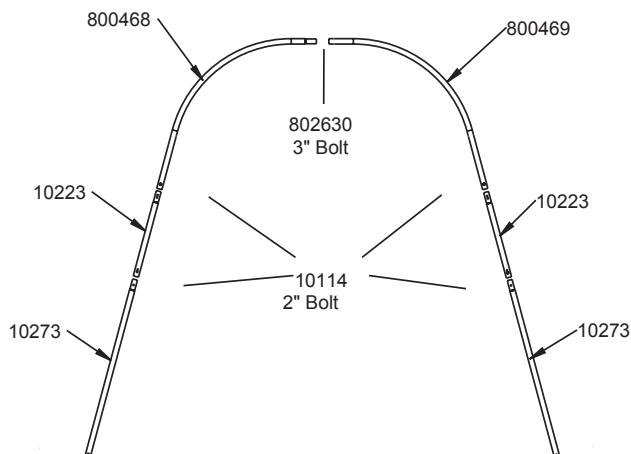
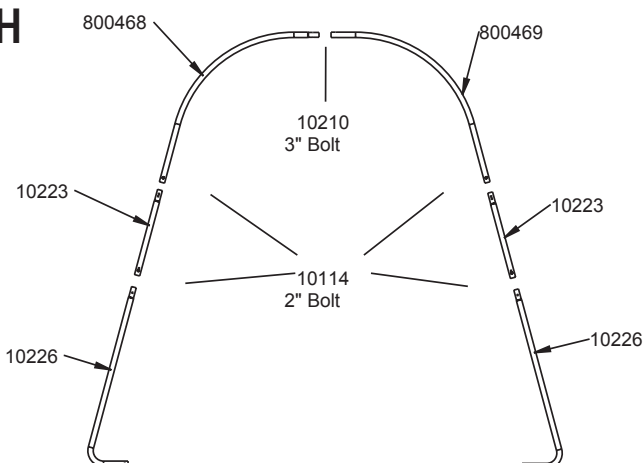

3. INSTALL SIDE RAILS AND SHELTERLOCK™ STABILIZER BLOCKS:

- A. Place assembled first end rib in the staked area. Place the ShelterLock™ on the upright as shown in Detail D. From the outside of the rib insert the bolt through the upright and then through the ShelterLock™.
- B. Place the plain end of the side rail over the bolt and nest it into the ShelterLock™. Install the nut onto the bolt and tighten. Repeat these steps for the opposite side and all of the remaining ribs. The side rails for the last rib will have two plain ends.

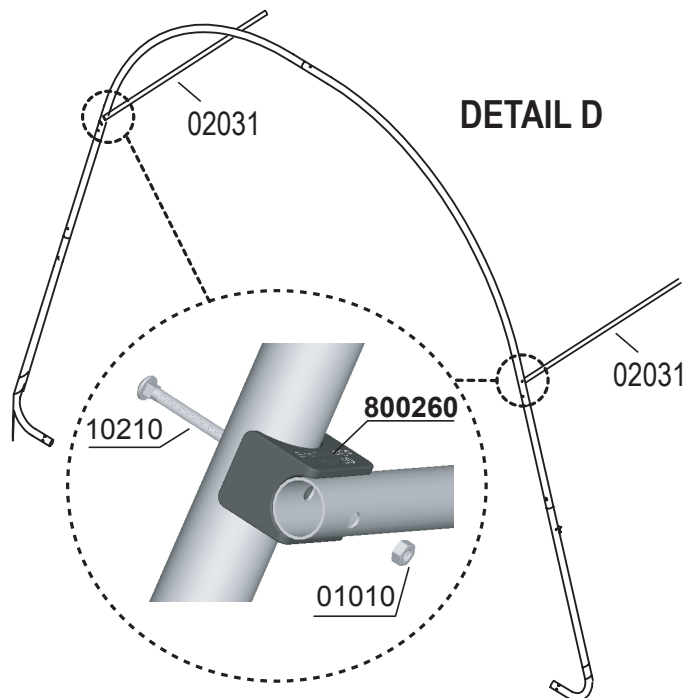

4. INSTALL WIND BRACES:

- A. Attach wind brace between the end rib and the first middle rib as shown in Detail E. Bolts attached at the cross rails should be inserted facing inside the shelter. Assemble cover rails as shown.

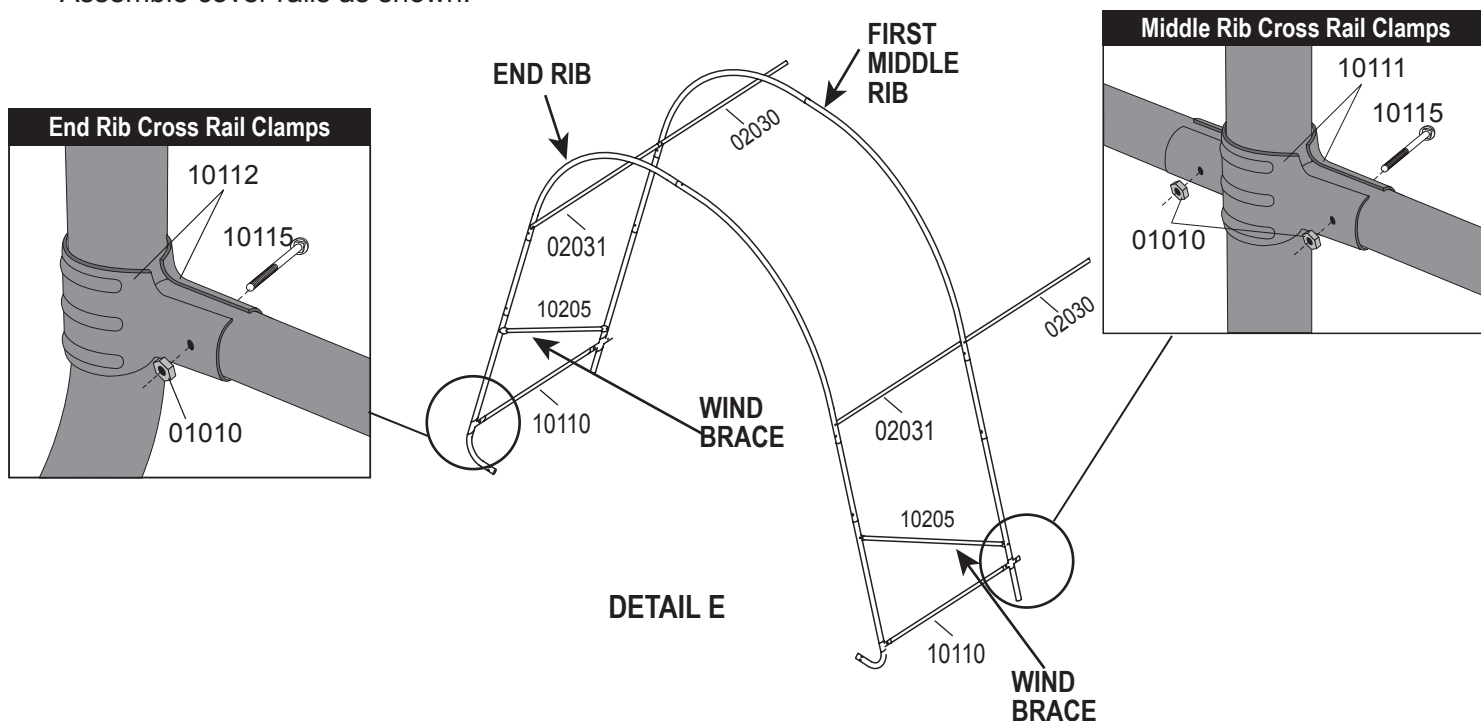

5. INSTALL TOP RAIL:

Place the first top rail under each end rib and secure it with a bolt as shown in Detail F. The same cross rail should lay on top of the all middle ribs. Secure the rails to the frame with the hardware indicated in Detail F. The top rail attached to the last rib will be installed under the pipe.

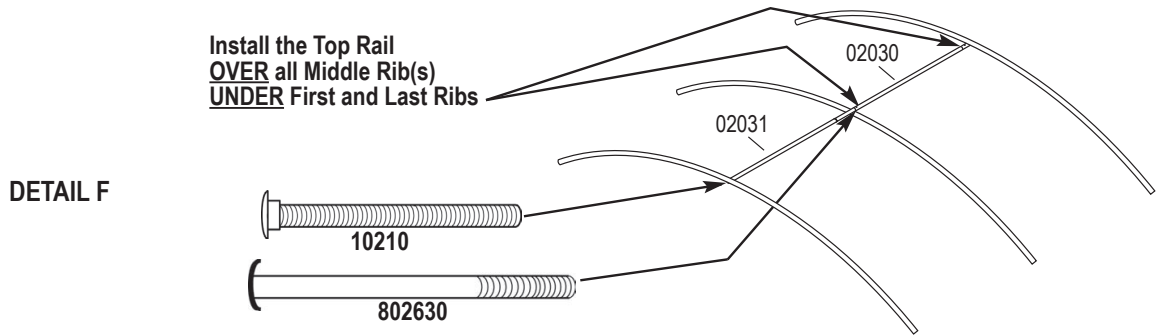

6. SECURE BASE FEET:

Slide leg pipe over over the base feet, line up the holes in the pipe with the holes in the feet and secure with the hardware indicated in Detail G.

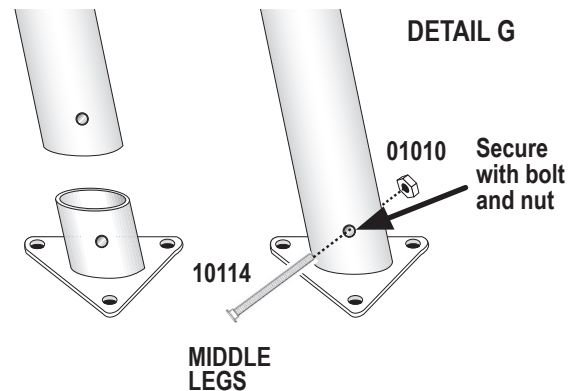

7. PROPERLY ANCHOR THE FRAME

- Anchors must be placed inside shelter at the corners of the shelter.
- Insert a $\frac{3}{4}$ " pipe or steel rod, through the eyelet of the auger and screw the anchor into the ground until the eyelet is sticking out of the ground by 1-2" so it can be anchored to the legs.
*If ground is too hard, dig a hole with a shovel or post hole tool. **Optional:** Fill with cement.*
- Wrap cable provided through the eyelet of the anchor and around the frame as shown below. Secure the cable with the clamps provided.

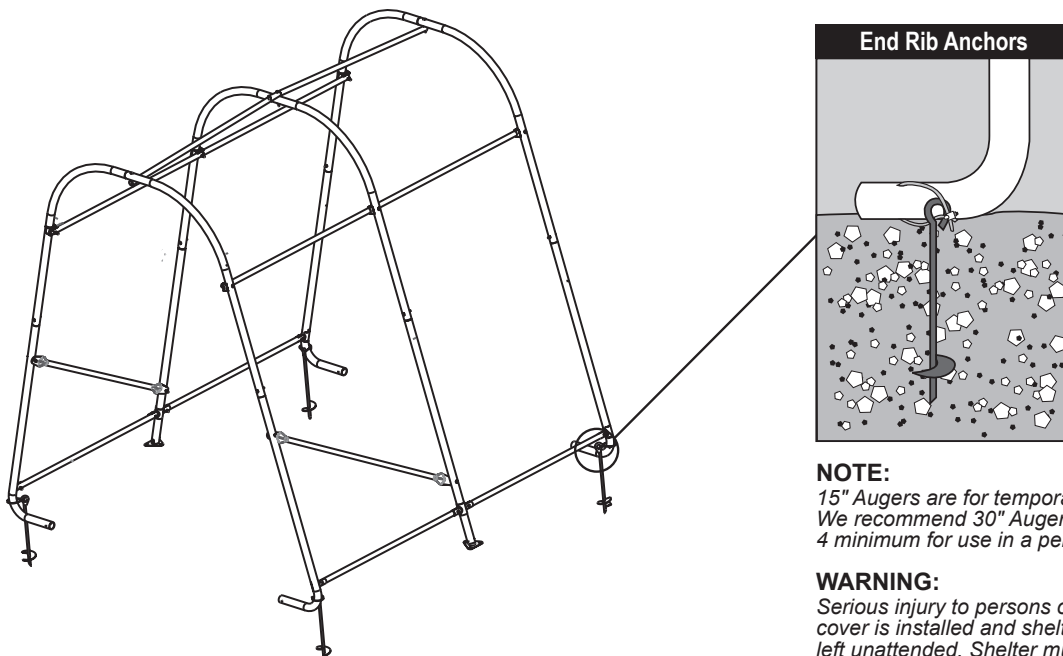

8. DOOR AND SOLID END PANEL INSTALLATION

- A. Hold end panel at the top center with white inner surface facing inside of the shelter. Wrap the edges of the fabric panel around the end rib and pass the rails through the pre made slits in the fabric.
- B. Disconnect top rail from the end rib. The top cross rail should pass through the slit in the fabric, and be inbetween the webbing and rib frame. Cut slit as needed to get cover tight.

Repeat Step B for side cross rails and wind braces.

- C. At the bottom, where the webbing exits the pocket on each side of end panel, pull webbing to remove the slack. **Be careful not to pull the webbing through the other side of the webbing pocket.**
- D. Insert the "S"- Hook on ratchet into hole on the leg bend. Insert the webbing into the spindle of the ratchet and pull tight. Wind the ratchet so that the webbing overlaps itself.

Position the end panel so that it is centered on the building before fully tightening the end panel.

- E. Tighten ratchets, alternating from one side to the other, until the end panel is tight.

Zipper Door Panels: Zippers must be closed when tightening end panel.

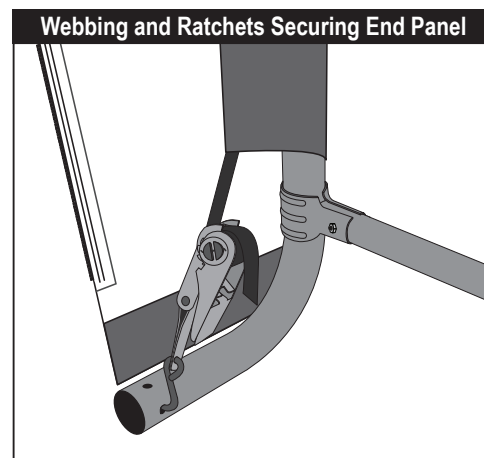
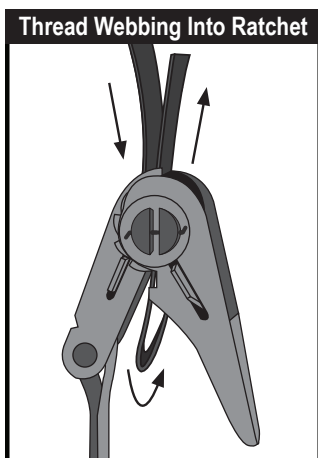
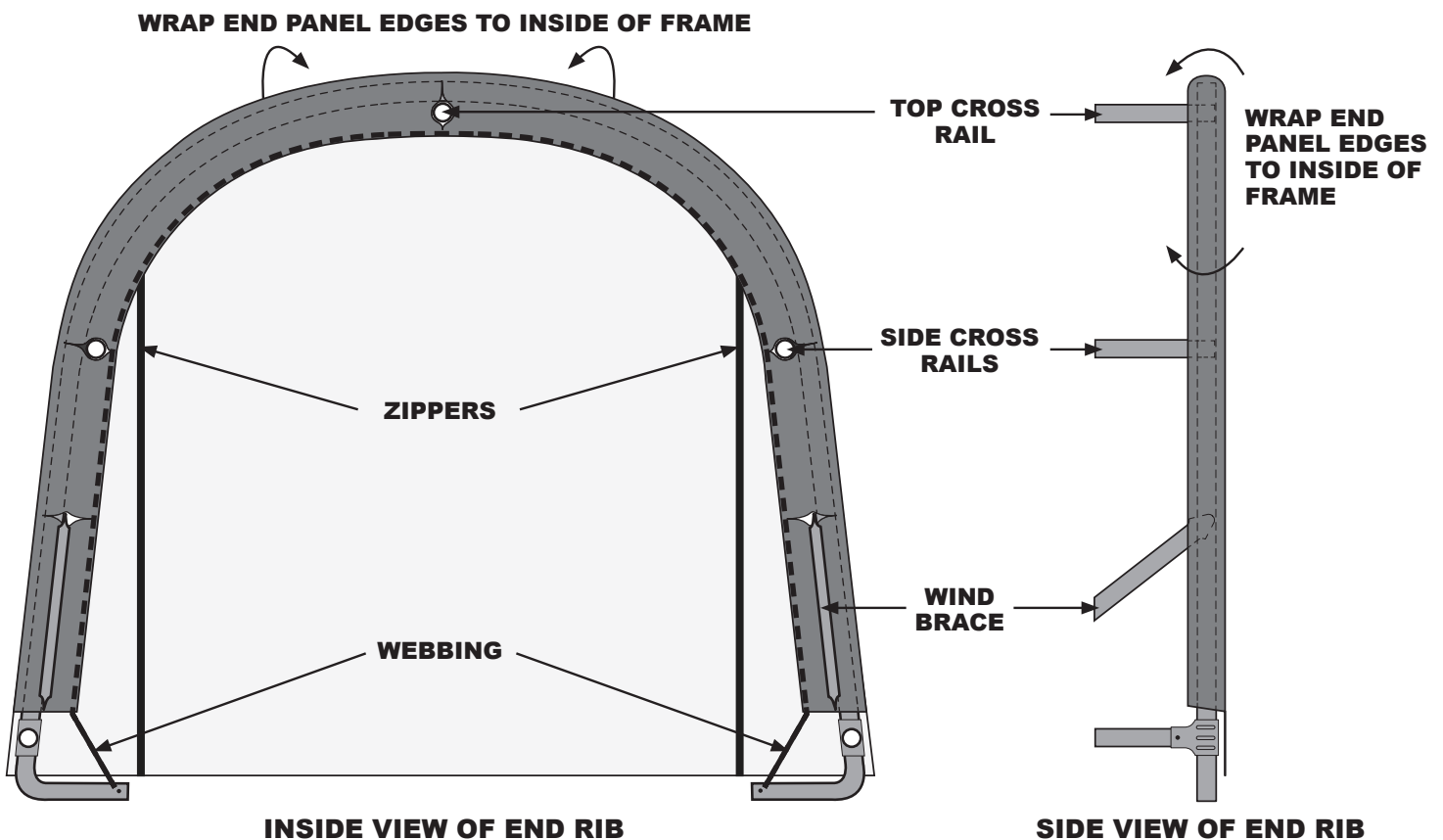

9. INSTALLING COVER AND COVER RAILS

- A. Lay the cover on the ground next to the frame with inside of the cover (the side with the pipe pockets) facing down and the webbing on the front and rear of the corner of the building.
- B. Pull cover over the frame, making sure to center cover on frame. There should be an equal amount of overhang at all four corners.
- C. Insert the "S"- Hook on ratchet into hole on the leg bend. Insert the webbing into the spindle of the ratchet and pull tight. Wind the ratchet so that the webbing overlaps itself.
- D. Disassemble cover rails and slide through fabric pockets at each leg and reattach with clamps to each leg. Repeat this on other side. Push down on cover rails to tighten cover, before tightening bolts completely.
- E. Check and tighten Ratchets and Cover Rails monthly to ensure the cover is tight.

NOTE: The *ShelterLogic*® logo should be oriented as shown below.

