

# DEFIANT®

FOR

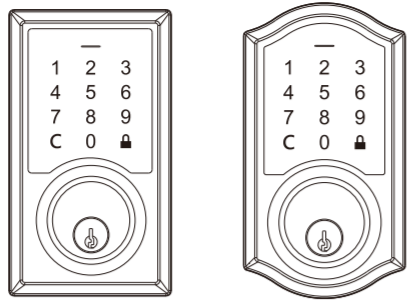

Questions, problems, missing parts? Before returning to the store, call Defiant Customer Service  
**TOLL FREE HELP LINE 1-877-ONE-LOCK**  
**HOMEDEPOT.COM**  
 08:30 a.m.-05:30 p.m., EST, Monday - Friday

## WARRANTY

### LIMITED LIFETIME MECHANICAL AND 1 YEAR ELECTRONIC WARRANTY

The retailer of this product, hereby warrants, subject to the conditions set forth below, that it will either repair or replace, at its option, this product if it proves to be defective by reason of improper workmanship or materials within the original purchaser's limited time. In order to obtain repairs or replacement under this limited warranty you must bring this product to the retailer's store in which you bought it. Original purchaser: This limited warranty is limited to the original purchaser at retail of this product from retailer. Except to the extent prohibited by applicable law, no other warranties, whether express or implied, including the warranties of merchantability and fitness for a particular purpose, shall apply to this product. Under no circumstances shall retailer be liable for consequential or incidental damages in connection with this product. To the extent retailer is prohibited by applicable law from excluding implied warranties, the duration of such implied warranties which are not excludable shall be the original purchaser's lifetime. Some states do not allow the limitation on how long an implied warranty lasts, so the above limitation on the duration of implied warranties which are not excludable, if any, may not apply to you. Some states do not allow the exclusion or limitation of incidental or consequential damages, so the above limitation or exclusion of incidental or consequential damages may not apply to you. Retailer neither assumes nor authorizes any representative or other person to assume for it any obligation or liability other than such as is expressly set forth herein. This limited warranty gives you specific legal rights, and you may also have other rights which vary from state to state.

## 1 SAFETY INFORMATION

Read the precautions and instructions in this manual before installing and using this lock. Save this manual for future reference.

**CAUTION:** Please use four alkaline batteries for the best performance.

- A. Do not attempt to disassemble any internal components of the lockset. Doing so will void the limited warranty.
- B. Do not drop or hit the lockset. Too much shock may result in permanent damage.
- C. Do not use pins or sharp objects to press the keypad.
- D. Always create a backup of information you wish to keep (Master Code, User Codes, etc.) Please use the last page of this booklet as a reference.
- E. Promptly change the Master Code before operating this lockset

**CARE and MAINTENANCE:** The following instructions should be followed to properly protect and maintain your lockset:

- A. Remove locks, or do not install locks, prior to painting your door.
- B. Periodically clean with mild soap and a soft cloth only.
- C. Do not use any abrasives or chemical products containing alcohol, benzene, acids, and avoid using sharp or abrasive objects to clean this lockset.
- D. Do not allow any water or liquids into the lockset during installation.

## 2 PRE-INSTALLATION - TOOLS REQUIRED / HARDWARE INCLUDED

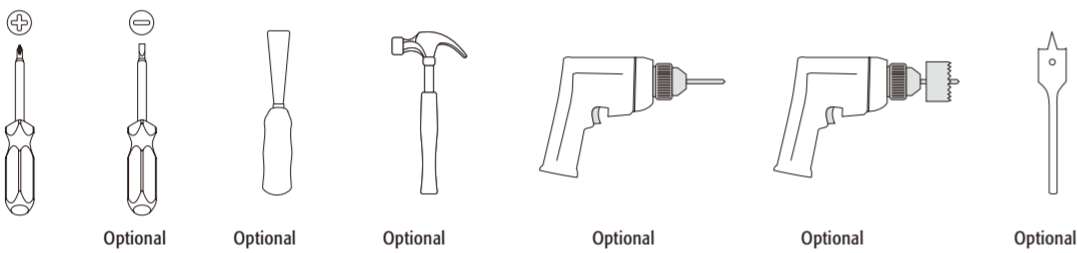

**WARNING:** If the door needs to be drilled, please be familiar with how to use a drill safely and understand all of the door preparation steps before proceeding.

## PACKAGE CONTENTS LIST

Part	Description	Quantity
A	Exterior Assembly	1
B	Power Cable	1
C	Torque blade	1
D	Mounting Plate	1
E	Interior Assembly	1
F	Battery Cover	1
G	Latch	1
H	Strike Plate	1
I	Dust Box	1
J	Key	2
K	Drive-in Collar (Optional)	1
L	Exterior Gasket	1

## HARDWARE CONTENTS (Actual Size)

Part	Description	Quantity
AA	1-13/16" (46 mm) Mounting Bolt	2
BB	3/4" (19 mm) Screw	2
CC	3/4" (19 mm) Wood Screw	4

## BEFORE PROCEEDING

### Check Dimensions

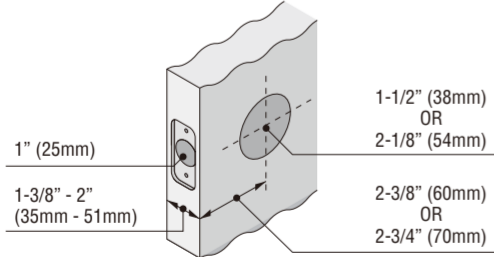

## 3 DOOR DRILLING FOR NEW INSTALLATION

**1 CUT OUT TEMPLATE AND USE TO MARK THE DOOR, DRILL HOLES, AND CHISEL OUT THE MORTISE.**

**NOTE:** If your door already has holes, skip to step **4**

**WARNING:** Drill from both sides of the door to prevent wood splitting.

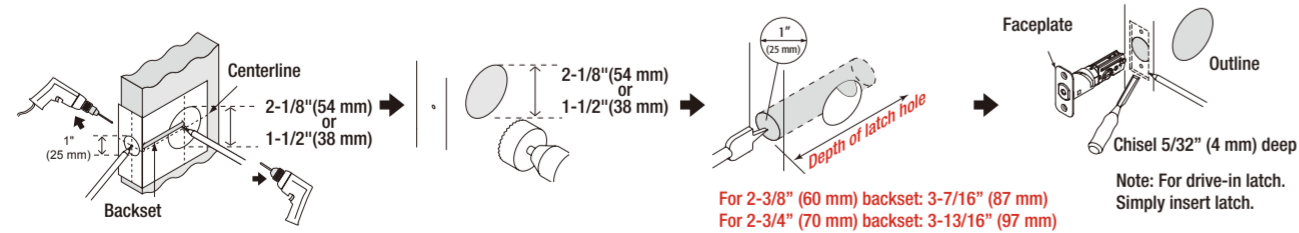

**2 PREPARE THE DOOR JAMB - USE THE STRIKE PLATE AS A TEMPLATE TO DRILL THE LATCH AND SCREW HOLES AND CHISEL OUT THE MORTISE. THE STRIKE PLATE MUST FIT FLUSH WITH THE SURFACE OF THE DOOR JAMB.**

- Door jamb hole dimension
- a. 1-3/16" (30 mm)
  - b. 1-9/64" (29 mm)
  - c. 7/8" (22 mm)
- Strike dimensions
- d. 5/32" (4 mm)
  - e. 2-1/4" (57 mm)
  - f. 1" (25 mm)

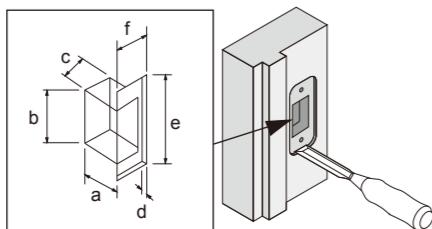

## 4 INSTALLATION

### 1 INSTALLING THE LATCH

#### A. Attach the correct faceplate

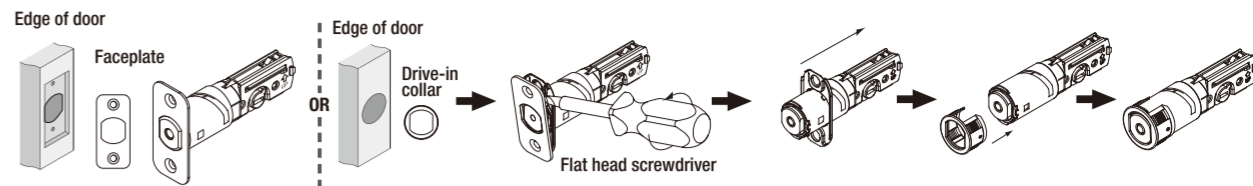

#### B. Set the latch backset length

Your latch is set for 2-3/8" backset. It can be adjusted if needed to 2-3/4" (skip this if your door has a 2-3/8" backset).

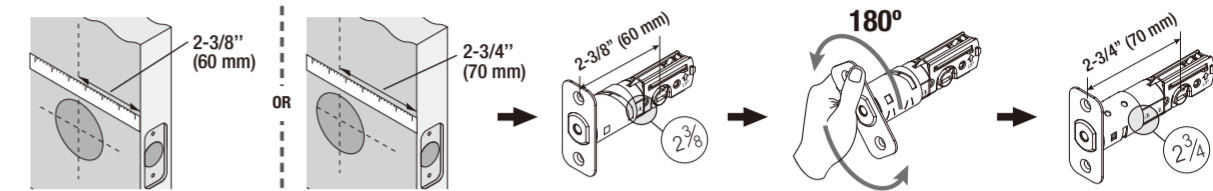

#### C. Install the latch

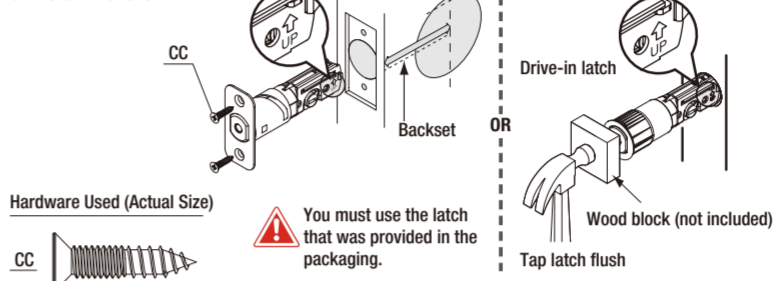

#### D. Install strike plate in door jamb

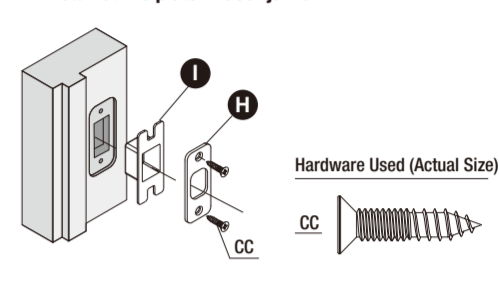

### 2 INSTALLING THE LOCK ASSEMBLIES

#### A. Thread the cable through the hole and under the latch.

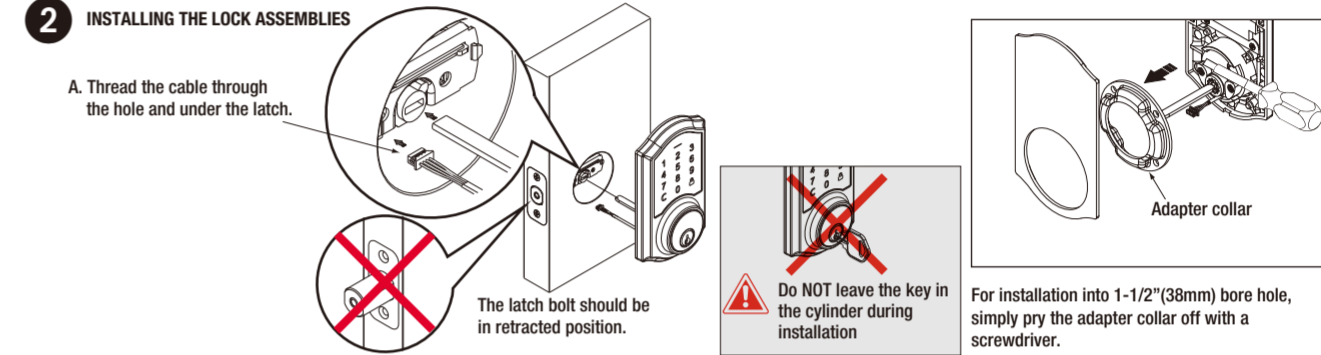

#### B. Install the lock assemblies

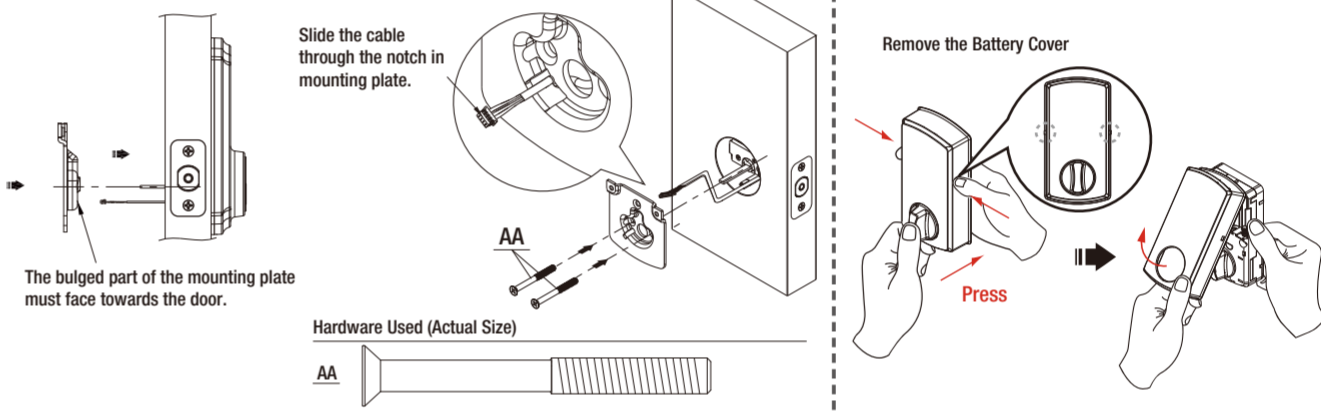

### 3

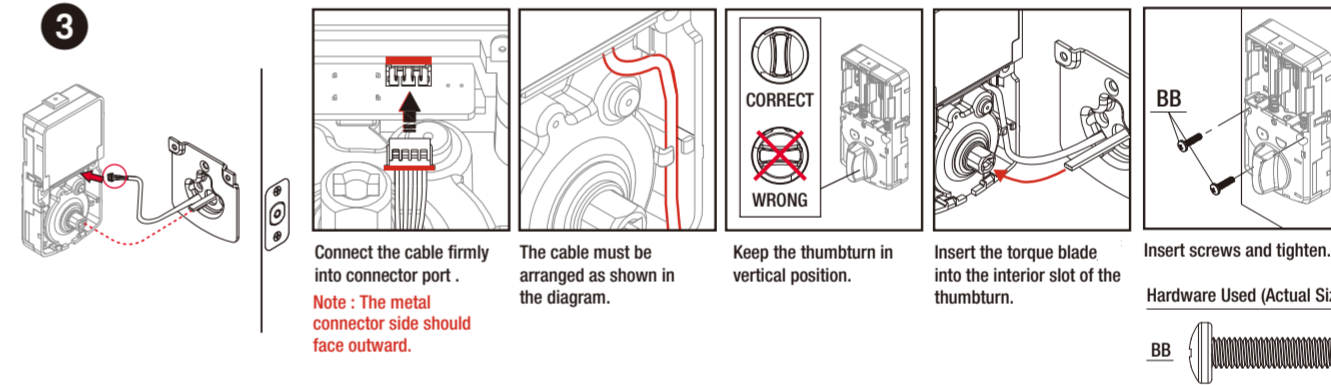

### 4

- CAUTION:**
1. Please use four alkaline batteries for better performance. Be sure to insert them correctly by matching the + and - polarity markings. Do not mix old batteries and new batteries or standard (carbon-zinc) with alkaline batteries.
  2. Please activate the lockset by entering the DEFAULT MASTER CODE (123456) to finish installation.
  3. Install and test lock with door OPENED to avoid being locked out.

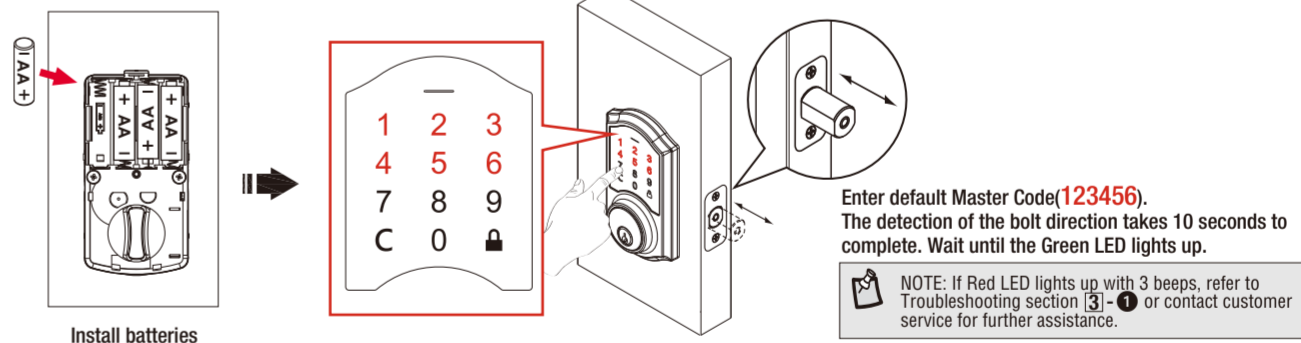

## TEMPLATE

