



MAGNUM[®]

TRUEAIRLESS[™]

Electric Airless Sprayer

OWNERS MANUAL

X5, X7, ProX17, ProX19, ProX21
3A3208B

EN



WARNING

FIRE AND EXPLOSION HAZARD

X5/X7 Models:

- Use only non-flammable or water-based materials, or non-flammable paint thinners. Do not use materials having flash points lower than 100° F (38° C). This includes, but is not limited to, acetone, xylene, toluene, or naphtha. For more information about your material, request Safety Data Sheet (SDS) from the supplier.
- Spraying flammable or combustible materials in a factory or fixed location must comply with NFPA 33 and OSHA 1910.94(c) requirements in the USA and with all similar local regulations in other countries.

***Not approved for use in explosive atmospheres or hazardous locations.
For portable airless spraying of architectural paints and coatings.***



Important Safety Instructions

Read all warnings and instructions in this manual, related manuals, and on the unit. Be familiar with the controls and the proper usage of the equipment. Save these instructions.

Before You Spray

Before You Spray

Review Warnings for Important Safety Information

Important! Read carefully and practice good safety habits.

Review Manual & Watch Videos

Scan QR code for Operational Video or go to magnum.graco.com/magop

Related Manuals

Gun: 312830 (SG)
ProXChange™ Pump: 3A3172 (ProX only)



Models

3000 psi (207 bar, 20.7 MPa) Maximum Working Pressure

	VAC	Model	Stand (Series)	Cart (Series)
 Intertek 110474 Certified to CAN/CSA C22.2 No. 68 Conforms to UL 1450	120 USA	X5	262800 (E) 17K437 (A)	
		X7		262805 (D)
		ProX17	17G177 (A) 17K438 (A)	17G178 (A)
		ProX19	17G179 (A)	17G180 (A) 17K439 (A)
		ProX21	17G181 (A)	17G182 (A)

Contents

Before You Spray	2
Warnings	4
Know Your Sprayer	8
Setup	12
Start Up	13
Pressure Relief Procedure	13
How to Spray	16
Adjust Pressure Control	17
Spray Techniques	17
Clear Tip Clog	18
Cleanup	19
Storage	23
Reference	25
Spray Tip Selection	25
Cleaning Fluid Compatibility	26
Static Grounding Instructions (Oil-Based materials)	26
Maintenance	29
Troubleshooting	32
X5: 262800, 17K437 Stand Sprayer Parts	36
X7: 262805 Cart Sprayer Parts	38
ProX17: 17G177, 17K438, ProX19: 17G179 Stand Sprayer Parts	40
ProX21: 17G181 Stand Sprayer Parts	42
ProX17: 17G178, ProX19: 17G180, 17K439 Cart Sprayer Parts	44
ProX21: 17G182 Cart Sprayer Parts	46
ProXChange Pump (ProX only)	48
Wiring Diagram - 110/120V	50
X5/X7:	50
ProX:	50
Technical Specifications	51
Notes	53
Notes	54
Graco Standard Warranty	55
Graco Information	56

Warnings

The following warnings are for the setup, use, grounding, maintenance, and repair of this equipment. The exclamation point symbol alerts you to a general warning and the hazard symbols refer to procedure-specific risks. When these symbols appear in the body of this manual or on warning labels, refer back to these Warnings. Product-specific hazard symbols and warnings not covered in this section may appear throughout the body of this manual where applicable.

WARNING



GROUNDING

This product must be grounded. In the event of an electrical short circuit, grounding reduces the risk of electric shock by providing an escape wire for the electric current. This product is equipped with a cord having a grounding wire with an appropriate grounding plug. The plug must be plugged into an outlet that is properly installed and grounded in accordance with all local codes and ordinances.

- Improper installation of the grounding plug is able to result in a risk of electric shock.
- When repair or replacement of the cord or plug is required, do not connect the grounding wire to either flat blade terminal.
- The wire with insulation having an outer surface that is green with or without yellow stripes is the grounding wire.
- Check with a qualified electrician or serviceman when the grounding instructions are not completely understood, or when in doubt as to whether the product is properly grounded.
- Do not modify the plug provided; if it does not fit the outlet, have the proper outlet installed by a qualified electrician.
- This product is for use on a nominal 120V circuit and has a grounding plug similar to the plugs illustrated below.

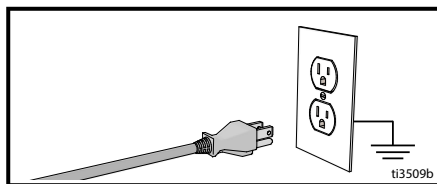

- Only connect the product to an outlet having the same configuration as the plug.
- Do not use an adapter with this product.

Extension Cords:

- Use only a 3-wire extension cord that has a grounding plug and a grounding receptacle that accepts the plug on the product.
- Make sure your extension cord is not damaged. If an extension cord is necessary use 12 AWG (2.5mm²) minimum to carry the current that the product draws.
- An undersized cord results in a drop in line voltage and loss of power and overheating.

Conductor Size		Length
AWG (American Wire Gauge)	Metric	Maximum
16	1.5 mm ²	25 ft. (8 m)
12	2.5 mm ²	50 ft. (15 m)

WARNING
**FIRE AND EXPLOSION HAZARD**

Flammable fumes, such as solvent and paint fumes, in work area can ignite or explode. To help prevent fire and explosion:

**X5/X7 Models:**

- Do not spray or clean with materials having flash points lower than 100°F (38° C). Use only non-flammable or water-based materials, or non-flammable paint thinners. For complete information about your material, request the Safety Data Sheet (SDS) from the material distributor or retailer.
- Do not spray combustible materials near an open flame or sources of ignition such as cigarettes, motors, and electrical equipment.
- Do not spray combustible liquids in a confined area.

**ProX Models:**

- Do not spray flammable or combustible materials near an open flame or sources of ignition such as cigarettes, motors, and electrical equipment.
- Do not spray flammable or combustible liquids in a confined area.

All Models:

- Paint or solvent flowing through the equipment is able to result in static electricity. Static electricity creates a risk of fire or explosion in the presence of paint or solvent fumes. All parts of the spray system, including the pump, hose assembly, spray gun, and objects in and around the spray area shall be properly grounded to protect against static discharge and sparks. Use Graco conductive or grounded high-pressure airless paint sprayer hoses.
- Verify that all containers and collection systems are grounded to prevent static discharge. Do not use pail liners unless they are anti-static or conductive.
- Connect to a grounded outlet and use grounded extensions cords. Do not use a 3-to-2 adapter.
- Do not use a paint or a solvent containing halogenated hydrocarbons.
- Keep spray area well-ventilated. Keep a good supply of fresh air moving through the area.
- Sprayer generates sparks. Keep pump assembly in a well ventilated area a least 20 feet (6.1 m) from the spray area when spraying, flushing, cleaning, or servicing. Do not spray pump assembly.
- Do not smoke in the spray area or spray where sparks or flame is present.
- Do not operate light switches, engines, or similar spark producing products in the spray area.
- Keep area clean and free of paint or solvent containers, rags, and other flammable materials.
- Know the contents of the paints and solvents being sprayed. Read all Safety Data Sheets (SDSs) and container labels provided with the paints and solvents. Follow the paint and solvents manufacturer's safety instructions.
- Fire extinguisher equipment shall be present and working.

WARNING



SKIN INJECTION HAZARD

High-pressure spray is able to inject toxins into the body and cause serious bodily injury. In the event that injection occurs, **get immediate surgical treatment**.

- Do not aim the gun at, or spray any person or animal.
- Keep hands and other body parts away from the discharge. For example, do not try to stop leaks with any part of the body.
- Always use the nozzle tip guard. Do not spray without nozzle tip guard in place.
- Use Graco nozzle tips.
- Use caution when cleaning and changing nozzle tips. In the case where the nozzle tip clogs while spraying, follow the **Pressure Relief Procedure** for turning off the unit and relieving the pressure before removing the nozzle tip to clean.
- Equipment maintains pressure after power is shut off. Do not leave the equipment energized or under pressure while unattended. Follow the **Pressure Relief Procedure** when the equipment is unattended or not in use, and before servicing, cleaning, or removing parts.
- Check hoses and parts for signs of damage. Replace any damaged hoses or parts.
- This system is capable of producing 3000 psi. Use Graco replacement parts or accessories that are rated a minimum of 3000 psi.
- Always engage the trigger lock when not spraying. Verify the trigger lock is functioning properly.
- Verify that all connections are secure before operating the unit.
- Know how to stop the unit and bleed pressure quickly. Be thoroughly familiar with the controls.



EQUIPMENT MISUSE HAZARD

Misuse can cause death or serious injury.

- Always wear appropriate gloves, eye protection, and a respirator or mask when painting.
- Do not operate or spray near children. Keep children away from equipment at all times.
- Do not overreach or stand on an unstable support. Keep effective footing and balance at all times.
- Stay alert and watch what you are doing.
- Do not operate the unit when fatigued or under the influence of drugs or alcohol.
- Do not kink or over-bend the hose.
- Do not expose the hose to temperatures or to pressures in excess of those specified by Graco.
- Do not use the hose as a strength member to pull or lift the equipment.
- Do not spray with a hose shorter than 25 feet.
- Do not alter or modify equipment. Alterations or modifications may void agency approvals and create safety hazards.
- Make sure all equipment is rated and approved for the environment in which you are using it.



ELECTRIC SHOCK HAZARD

This equipment must be grounded. Improper grounding, setup, or usage of the system can cause electric shock.

- Turn off and disconnect power cord before servicing equipment.
- Connect only to grounded electrical outlets.
- Use only 3-wire extension cords.
- Ensure ground prongs are intact on power and extension cords.
- Do not expose to rain. Store indoors.



WARNING



PRESSURIZED ALUMINUM PARTS HAZARD

Use of fluids that are incompatible with aluminum in pressurized equipment can cause serious chemical reaction and equipment rupture. Failure to follow this warning can result in death, serious injury, or property damage.

- Do not use 1,1,1-trichloroethane, methylene chloride, other halogenated hydrocarbon solvents or fluids containing such solvents.
- Do not use chlorine bleach.
- Many other fluids may contain chemicals that can react with aluminum. Contact your material supplier for compatibility.



MOVING PARTS HAZARD

Moving parts can pinch, cut, or amputate fingers and other body parts.

- Keep clear of moving parts.
- Do not operate equipment with protective guards or covers removed.
- Pressurized equipment can start without warning. Before checking, moving, or servicing equipment, follow the **Pressure Relief Procedure** and disconnect all power sources.



TOXIC FLUID OR FUMES HAZARD

Toxic fluids or fumes can cause serious injury or death if splashed in the eyes or on skin, inhaled, or swallowed.

- Read MSDSs to know the specific hazards of the fluids you are using.
- Store hazardous fluid in approved containers, and dispose of it according to applicable guidelines.



PERSONAL PROTECTIVE EQUIPMENT

Wear appropriate protective equipment when in the work area to help prevent serious injury, including eye injury, hearing loss, inhalation of toxic fumes, and burns. This protective equipment includes but is not limited to:

- Protective eyewear, and hearing protection.
- Respirators, protective clothing, and gloves as recommended by the fluid and solvent manufacturer.

CALIFORNIA PROPOSITION 65

This product contains a chemical known to the State of California to cause cancer, birth defects or other reproductive harm. Wash hands after handling.

Know Your Sprayer

Know Your Sprayer

X5 Stand Models

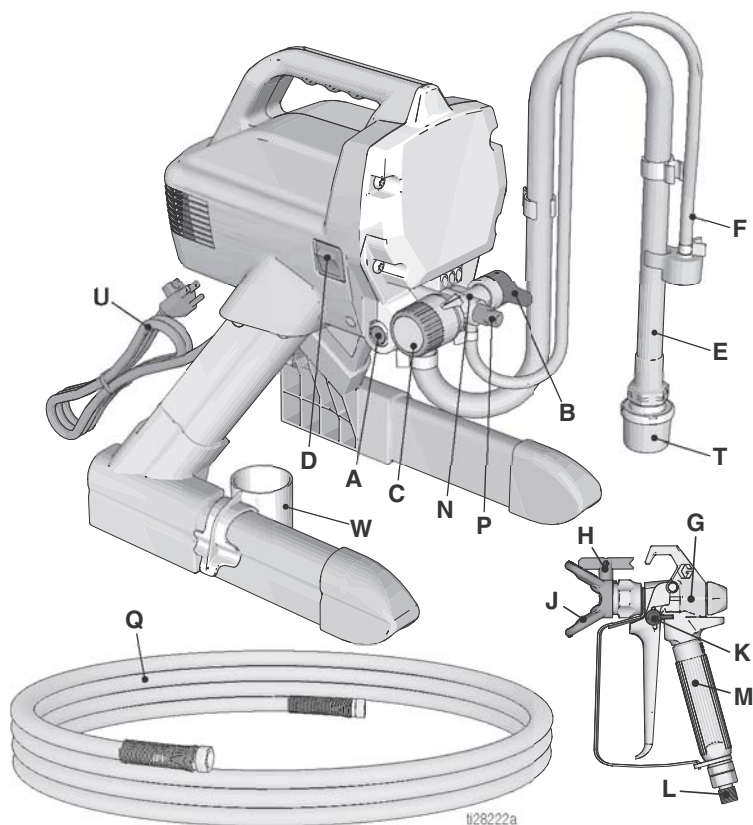

t128222a

A	PushPrime™ Button
B	Prime/Spray Valve
C	Pressure Control Knob
D	ON/OFF Switch
E	Suction Tube
F	Drain Tube (with diffuser)
G	Airless Spray Gun
H	Reversible Spray Tip
J	Tip Guard
K	Gun Trigger Lock
L	Gun Fluid Inlet Fitting

M	Gun Fluid Filter (inside handle)
N	Pump
P	Pump Fluid Outlet Fitting (airless hose connection)
Q	Airless Hose
T	Inlet Strainer
U	Power Cord
	Model/Serial Tag (Not shown, located on bottom of unit.)
W	Suction Tube Drip Cup
See Quick Reference , page 28 for more information.	

X7 Cart Model

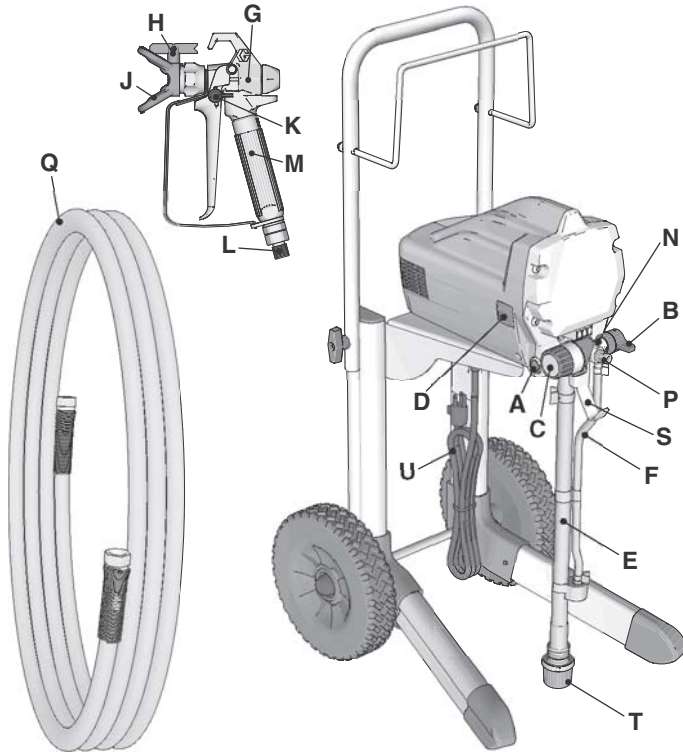

t128223a

A	PushPrime™ Button
B	Prime/Spray Valve
C	Pressure Control Knob
D	ON/OFF Switch
E	Suction Tube
F	Drain Tube (with diffuser)
G	Airless Spray Gun
H	Reversible Spray Tip
J	Tip Guard
K	Gun Trigger Lock
L	Gun Fluid Inlet Fitting

M	Gun Fluid Filter (inside handle)
N	Pump
P	Pump Fluid Outlet Fitting (airless hose connection)
Q	Airless Hose
S	Pail Hanger
T	Inlet Strainer
U	Power Cord
	Model/Serial Tag (Not shown, located on bottom of unit.)
See Quick Reference , page 28 for more information.	

Know Your Sprayer

ProX Stand Models

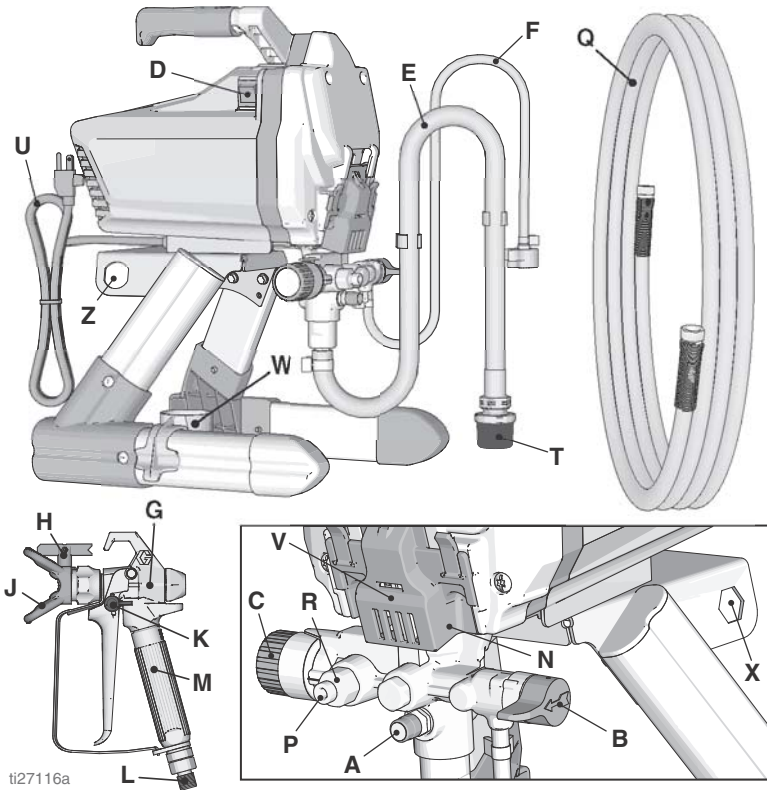

ti27116a

A	PushPrime™ Button
B	Prime/Spray Valve
C	Pressure Control Knob
D	ON/OFF Switch
E	Suction Tube
F	Drain Tube (with diffuser)
G	Airless Spray Gun
H	Reversible Spray Tip
J	Tip Guard
K	Gun Trigger Lock
L	Gun Fluid Inlet Fitting
M	Gun Fluid Filter (inside handle)
N	ProXChange™ Pump (behind Easy Access Door)

P	Pump Fluid Outlet Fitting (airless hose connection)
Q	Airless Hose
R	InstaClean™ Fluid Filter (inside fluid outlet)
T	Inlet Strainer
U	Power Cord
V	Easy Access Door
W	Suction Tube Drip Cup
X	Pump Removal Tool
Z	Inlet Valve Removal Tool
	Model/Serial Tag (Not shown, located on bottom of unit.)
See Quick Reference , page 28 for more information.	

ProX Cart Models

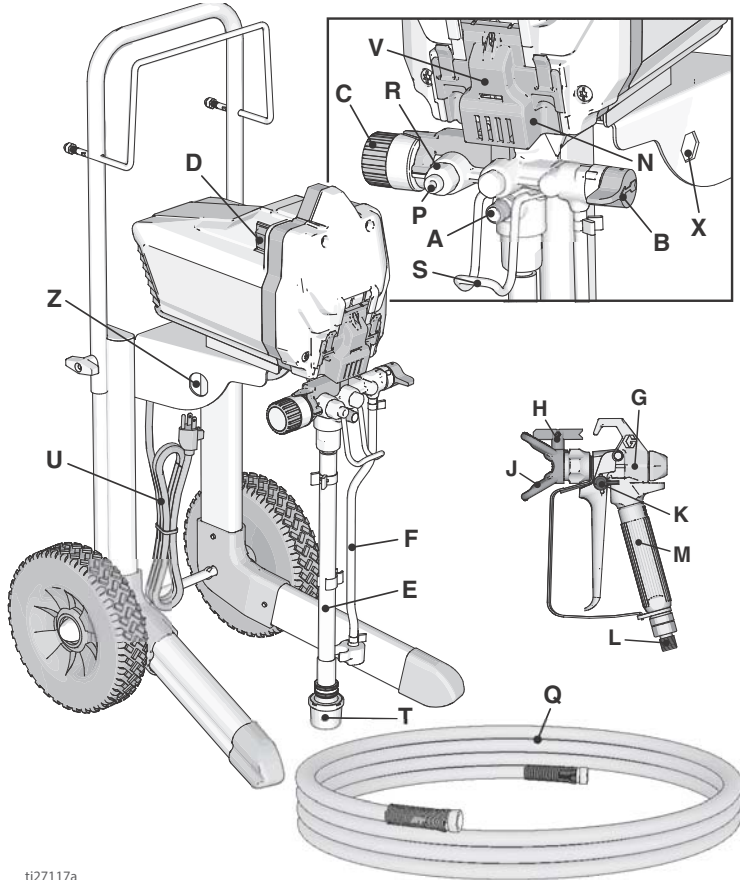

ti27117a

A	PushPrime Button
B	Prime/Spray Valve
C	Pressure Control Knob
D	ON/OFF Switch
E	Suction Tube
F	Drain Tube (with diffuser)
G	Airless Spray Gun
H	Reversible Spray Tip
J	Tip Guard
K	Gun Trigger Lock
L	Gun Fluid Inlet Fitting
M	Gun Fluid Filter (inside handle)
N	ProXChange Pump (behind Easy Access Door)

P	Pump Fluid Outlet Fitting (airless hose connection)
Q	Airless Hose
R	InstaClean Fluid Filter (inside fluid outlet)
S	Pail Hanger
T	Inlet Strainer
U	Power Cord
V	Easy Access Door
X	Pump Removal Tool
Z	Inlet Valve Removal Tool
	Model/Serial Tag (Not shown, located on bottom of unit.)
See Quick Reference , page 28 for more information.	

Setup

When unpacking sprayer for the first time or after long term storage perform setup procedure.

Assemble Your Sprayer

1. Connect Graco airless hose to fluid outlet. Use wrench to tighten securely.

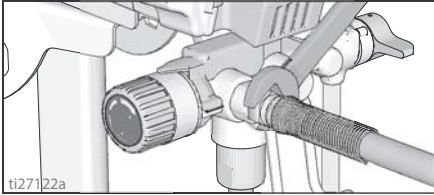

2. Connect other end of hose to gun.

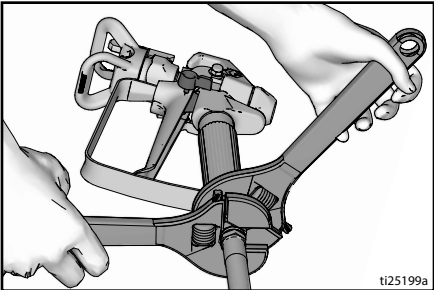

3. Use two wrenches to tighten securely. If hose is already connected, make sure connections are tight.
4. Engage trigger lock.

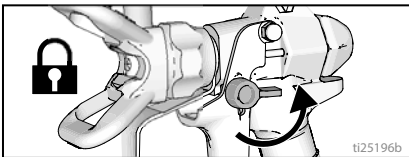

5. Remove tip guard. Be careful tip seal may fall out when tip guard is removed.

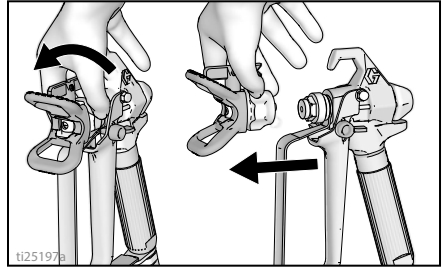

6. Turn pressure control knob all the way left (counter-clockwise) to lowest setting.

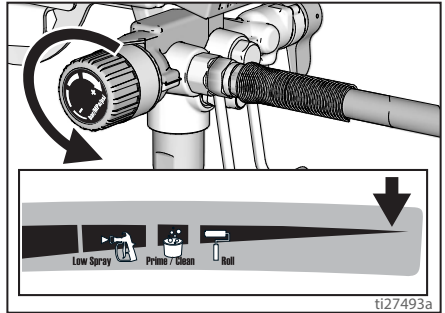

7. After long term storage check inlet strainer for clogs and debris.

Strain the Paint

Previously opened paint may contain dried paint or other debris. To avoid priming problems and spray tip clogs it is recommended to strain the paint before using. Paint strainers are available where paint is sold. Stretch a paint strainer over a clean pail and pour the paint through the strainer to capture any dried paint and debris before spraying.



Start Up

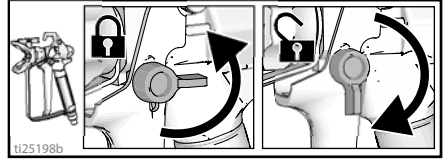

Pressure Relief Procedure



Follow the Pressure Relief Procedure whenever you see this symbol.

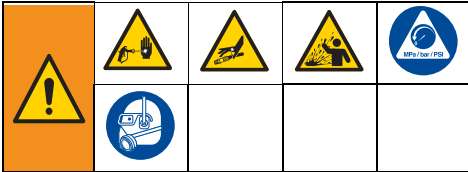

This equipment stays pressurized until pressure is manually relieved. To help prevent serious injury from pressurized fluid, such as skin injection or splashed fluid, follow the **Pressure Relief Procedure** whenever sprayer is stopped and before sprayer is cleaned or checked, and before equipment is serviced.

1. Turn ON/OFF switch to the **OFF** position.

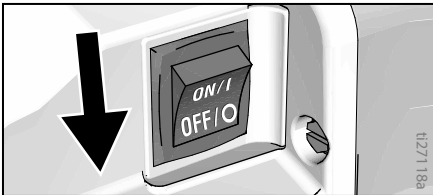

2. Engage the trigger lock. Always engage the trigger lock when sprayer is stopped to prevent the gun from being triggered accidentally.

3. Turn pressure control knob to lowest setting.

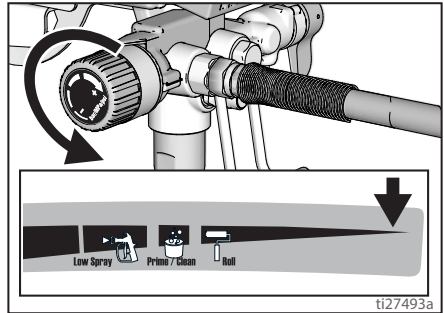

4. Put drain tube into a waste pail and turn Prime/Spray valve in **PRIME** position (drain) to relieve pressure.

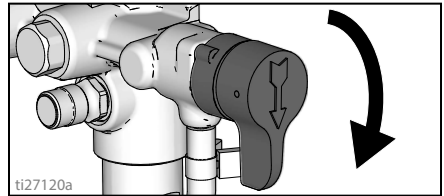

5. Hold the gun firmly to a pail. Point gun into pail. Disengage the trigger lock and trigger the gun to relieve pressure.

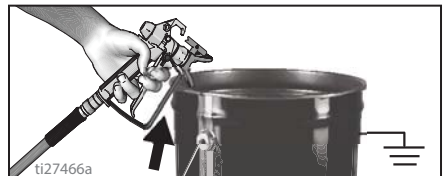

6. Engage the trigger lock.

Start Up

- If you suspect the spray tip or hose is clogged or that pressure has not been fully relieved:
 - VERY SLOWLY** loosen the tip guard retaining nut or the hose end coupling to relieve pressure gradually.
 - Loosen the nut or coupling completely.
 - Clear airless hose or spray tip obstruction. See **Clear Tip Clog**, page 18.

Flush Storage Fluid

This sprayer arrives from the factory with a small amount of test material in the system. **It is important that you flush this material from the sprayer before using it for the first time.** See **Cleaning Fluid Compatibility**, page 26 and **Static Grounding Instructions (Oil-Based materials)**, page 26 for additional information when using oil-based materials.

- Perform **Pressure Relief Procedure**, page 13.
- Make certain ON/OFF switch is **OFF**.
- Separate drain tube (smaller) from suction tube (larger).
- Place drain tube in a waste pail.
- Submerge suction tube in a pail partially filled with water or flushing fluid. If spraying oil-based materials, submerge the suction tube in mineral spirits, or compatible cleaning solvent. If spraying water-based materials, submerge the suction tube in water.

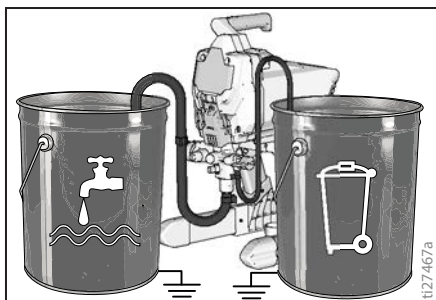

- Turn Prime/Spray valve down to **PRIME** position.

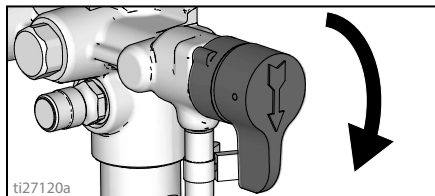

- Plug power supply cord into a properly grounded electrical outlet.
- Press PushPrime button twice to loosen inlet ball.

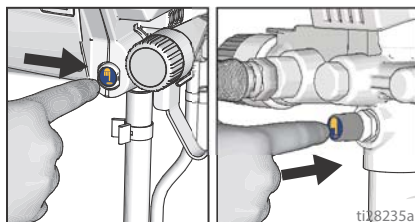

- Align setting indicator with Prime/Clean setting on pressure control knob.

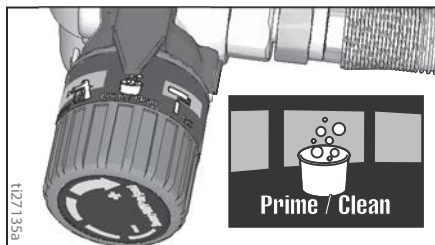

- Turn ON/OFF switch to **ON** position.

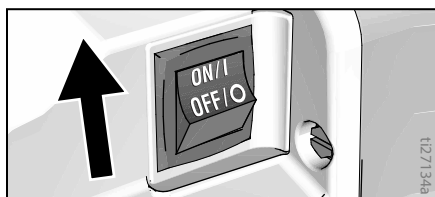

- When sprayer starts pumping, flushing solvent and air bubbles will be purged from system. Allow fluid to flow out of drain tube, into waste pail, for 30 to 60 seconds.
- Turn ON/OFF switch to **OFF** position.



- Inspect for leaks. If leaks occur, perform **Pressure Relief Procedure**, page 13, then tighten all fittings and repeat **Start Up**. If there are no leaks continue with the next step.

Fill Pump

- Move suction tube to paint pail and submerge suction tube in paint.

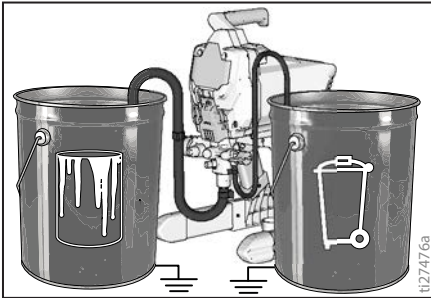

- Turn ON/OFF switch to **ON** position.
- Wait to see paint coming out of drain tube.
- Turn ON/OFF switch to **OFF** position.

NOTE: Some fluids may prime faster if the ON/OFF Switch is momentarily turned off so the pump can slow and stop. Turn ON/OFF switch on and off several times if necessary.

Fill Gun and Hose

- Hold gun against waste pail. Point gun into waste pail.
 - Disengage trigger lock.
 - Pull and hold gun trigger.
 - Turn Prime/Spray valve horizontal to **SPRAY** position.
 - Turn ON/OFF switch to **ON** position.

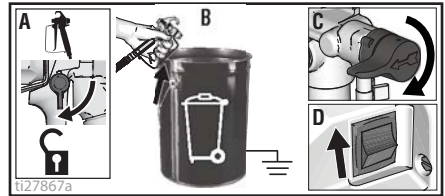

- Trigger gun into waste pail until only paint comes out of the gun.
- Release trigger. Engage trigger lock.
- Transfer drain tube to paint pail and clip to suction tube.

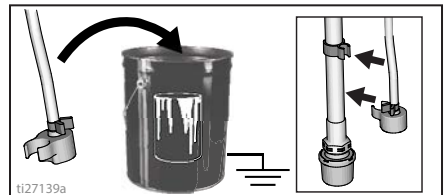

NOTE: When motor stops, sprayer is ready to paint. If motor continues to run, sprayer is not properly primed. Repeat **Fill Pump** and **Fill Gun and Hose**.

How to Spray

How to Spray

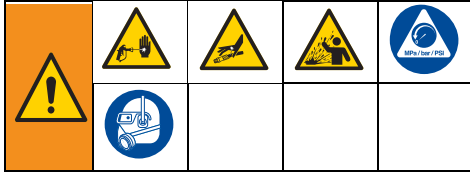

Spray Tip Installation

To prevent spray tip leaks make certain spray tip and tip guard are installed properly.

1. Perform **Pressure Relief Procedure**, page 13.
2. Engage trigger lock.
3. Verify spray tip and tip guard parts are assembled in the order shown.

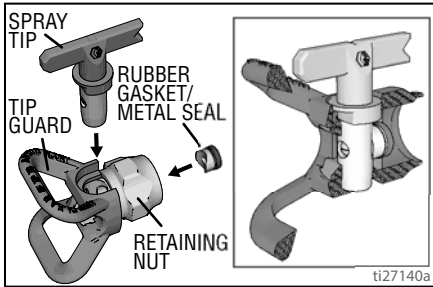

- a. Use spray tip to align gasket and seal in the tip guard.

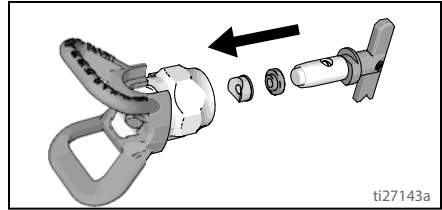

- b. Spray tip must be pushed all the way into the tip guard. Turn spray tip to push down.

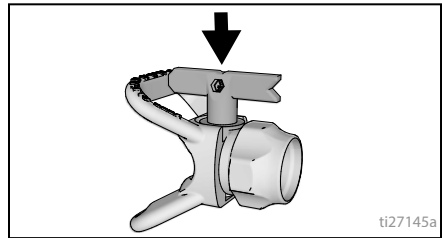

- c. Turn the arrow shaped handle on the spray tip forward to the spray position.
4. Screw spray tip and tip guard assembly onto the gun and tighten.

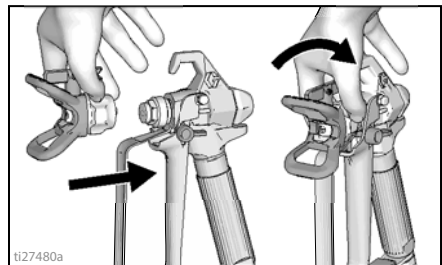

Adjust Pressure Control

The pressure control knob allows for infinite pressure adjustment. To reduce overspray, always start at the lowest pressure setting and increase pressure to the minimum setting that results in an acceptable spray pattern.

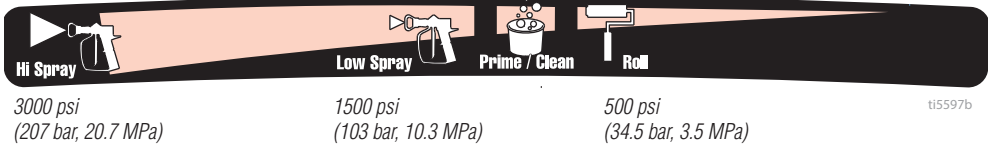

To select function, align symbol on pressure control knob with setting indicator on sprayer.

Tip and Pressure Selection

See table for recommended spray pressure for your material. Refer to paint (material) can for manufacturer's recommendations.

Maximum tip hole sizes supported by the sprayer:

- X5: 0.015 in. (0.38 mm) - X7: 0.017 in. (0.43 mm)
- ProX17: 0.017 in. (0.43 mm) - ProX19: 0.019 in. (0.48 mm) - ProX21: 0.021 in. (0.53 mm)

	Coatings				
	Interior Stains/ Interior & Exterior Clears	Exterior Solid Stains	Primers	Interior Latex Paints	Exterior Latex Paints
Spray Pressure	Low Spray	High Spray	High spray	High Spray	High Spray
Tip hole Size					
0.011 in. (0.28 mm)	✓				
0.013 in. (0.33 mm)	✓	✓	✓	✓	
0.015 in. (0.38 mm)		✓	✓	✓	✓
0.017 in. (0.43 mm)			✓	✓	✓
0.019 in. (0.48 mm)					✓
0.021 in. (0.53 mm)					✓

Spray Techniques

Use a piece of scrap cardboard to practice these basic spraying techniques before you begin spraying the surface.

- Hold gun 12 in. (30 cm) from surface and aim straight at surface. Tilting gun to direct spray angle causes an uneven finish.
- Flex wrist to keep gun pointed straight. Fanning gun to direct spray at angle causes uneven finish.

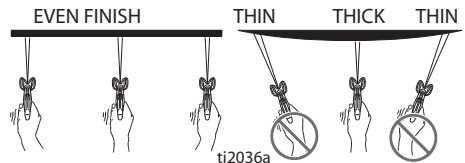
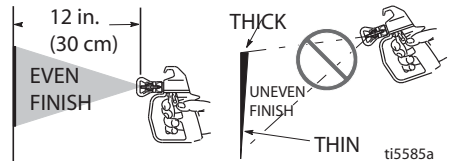

How to Spray

Triggering Gun

Pull trigger after starting stroke. Release trigger before end of stroke. Gun must be moving when trigger is pulled and released.

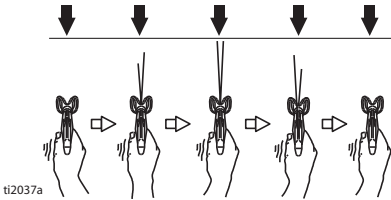

Aiming Gun

Aim center of spray of gun at bottom edge of previous stroke, overlapping each stroke by half.

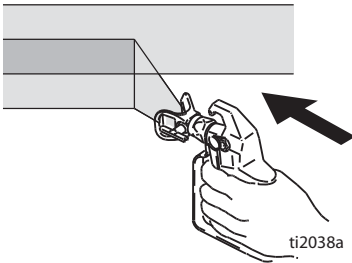

Spray Pattern Quality

A good spray pattern is evenly distributed as it hits the surface.

- Spray should be atomized (evenly distributed, no gaps at edges).

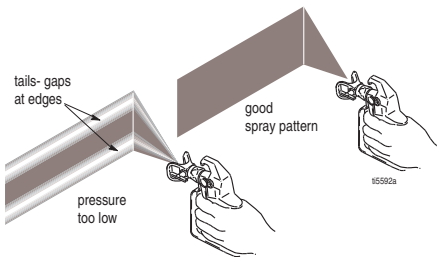

If tails persist when spraying at the highest spray pressure:

- Spray tip may be worn. See **Tip and Pressure Selection**, page 17.
- A smaller spray tip may be needed.

- Material may need to be thinned. If material needs to be thinned follow manufacturer's recommendations.

Clear Tip Clog

In the event that particles or debris clog the spray tip, this sprayer is designed with a reversible spray tip that quickly and easily clears the particles without disassembling the sprayer.

See **Strain the Paint**, page 12 for additional information.

1. Engage trigger lock. Rotate spray tip to unclog position. Disengage trigger lock. Trigger gun at waste area to clear clog.

UNCLOG

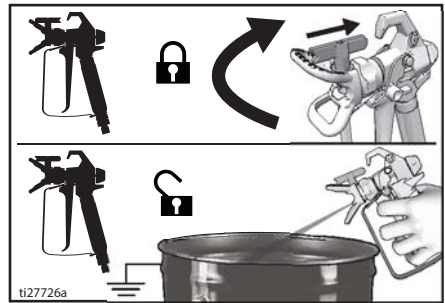

NOTE: If spray tip is difficult to rotate when turning to the unclog position perform, **Pressure Relief Procedure**, page 13, then turn Prime/Spray valve to spray position and repeat step 1.

2. Engage trigger lock. Rotate spray tip back to spray position. Disengage trigger lock and continue spraying.

SPRAY

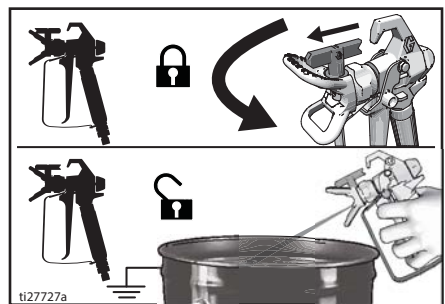

Cleanup

Cleaning the sprayer after each use results in a trouble free start up the next time the sprayer is used.

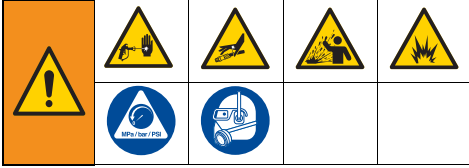

Cleaning from a Pail

- For short term shutdown periods (overnight to two days) refer to **Short Term Storage**, page 23.
 - See **Cleaning Fluid Compatibility**, page 26 for information on flushing/cleaning fluids and **Static Grounding Instructions (Oil-Based materials)**, page 26.
1. Perform **Pressure Relief Procedure**, page 13.
 2. Remove spray tip and tip guard assembly from gun and place in waste pail.

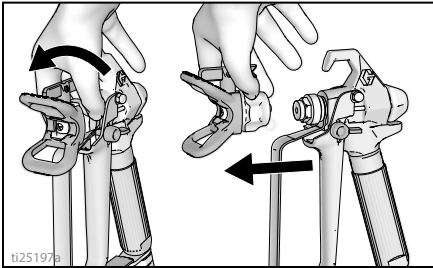

3. Lift suction tube and drain tube from paint pail. Let paint drain into the pail.
4. Separate drain tube (smaller) from suction tube (larger).

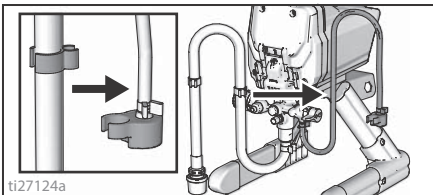

5. Place empty waste and flushing fluid pails side by side.
6. Place suction tube in flushing fluid. Use water for water based paint and mineral spirits or compatible oil-based flushing solvent for oil-based paint. Place drain tube in waste pail.

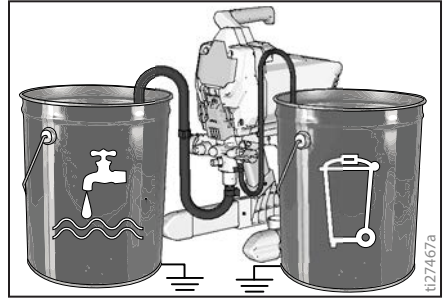

7. Turn pressure control knob to the Prime/Clean setting.

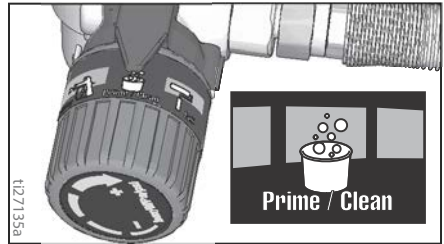

8. Turn Prime/Spray valve down to PRIME position.

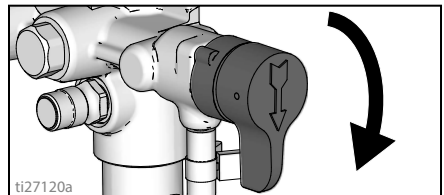

9. Turn ON/OFF switch to **ON** position.
10. Flush until approximately 1/3 of the flushing fluid is emptied from the pail.

Cleanup

- Turn ON/OFF switch to **OFF** position.

NOTE: Step 12 is for returning paint in hose to paint pail. One 50 ft (15 m) hose holds approximately 1 quart (1 liter) of paint.

- To recover paint in hose, point gun into paint pail while holding gun firmly to the pail.
 - Disengage trigger lock.
 - Pull and hold gun trigger.
 - Turn Prime/Spray valve horizontal to **SPRAY** position.
 - Turn ON/OFF switch to **ON** position.
 - Continue to hold gun trigger until you see paint diluted with flushing fluid starting to come out of gun.

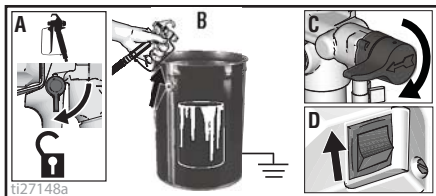

- While continuing to trigger gun, quickly move gun to redirect spray into waste pail. Continue triggering gun into waste pail until flushing fluid dispensed from gun is relatively clear.

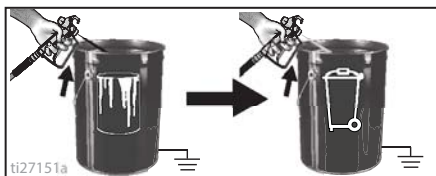

- Turn pressure control knob to the lowest setting.
- Stop triggering gun. Engage the trigger lock.

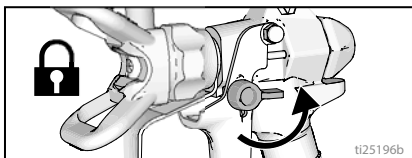

- Turn Prime/Spray valve down to **PRIME** position.
- Turn ON/OFF switch to **OFF** position.
- Clean outlet filter. ProX only: See **Cleaning InstaClean™ Fluid Filter (ProX only)**, page 22.
- Fill unit with Pump Armor™ fluid. See **Long Term Storage**, page 23.

Cleanup with Power Flush Adapter

(Water-based materials only)

Power flushing is a faster method of cleanup. It can only be used after spraying water-based coatings.

- Perform **Pressure Relief Procedure**, page 13.
- Remove spray tip and tip guard assembly from gun and place in waste pail.

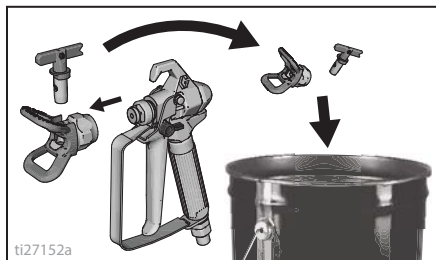

- Place empty waste and paint pails side by side.
- Lift suction tube and drain tube from paint pail. Let paint drain into the pail.
- Place suction and drain tube in waste pail.

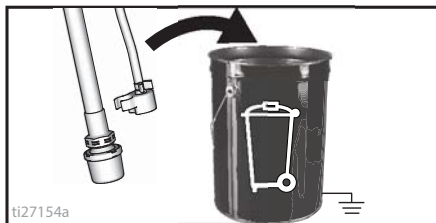

- Turn pressure control knob to the Prime/Clean setting.

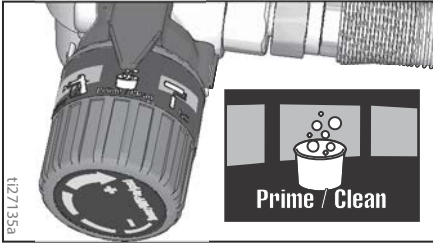

- Screw Power Flush attachment valve to garden hose. Close valve.

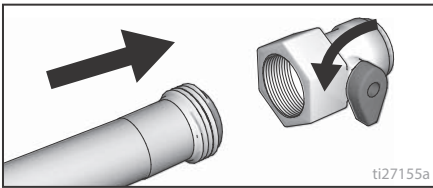

- Turn on water. Open valve. Rinse paint off suction tube, drain tube and inlet strainer. Close valve.

- Unscrew inlet strainer from suction tube. Place inlet strainer in waste pail.

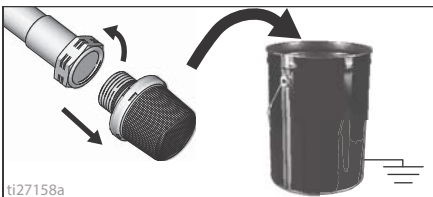

- Connect garden hose to suction tube with Power Flush attachment valve. Leave drain tube in waste pail.

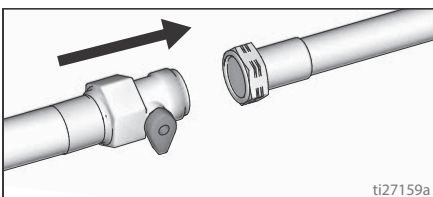

- Turn ON/OFF switch to **ON** position.
- Open Power Flush attachment valve.
- Circulate water through sprayer, into waste pail, for 20 seconds.
- Turn ON/OFF switch to **OFF** position.

NOTE: Step 15 is for returning paint in hose to paint pail. One 50 ft (15 m) hose holds approximately 1 quart (1 liter) of paint.

- To recover paint in hose, point gun into paint pail while holding gun firmly to the pail.
 - Disengage trigger lock.
 - Pull and hold gun trigger.
 - Turn Prime/Spray valve horizontal to **SPRAY** position.
 - Turn ON/OFF switch to **ON** position.
 - Continue to hold gun trigger until you see paint diluted with flushing fluid starting to come out of gun.

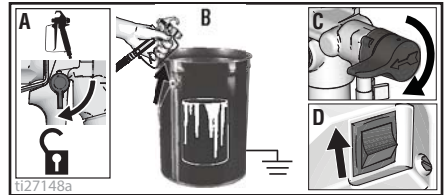

- While continuing to trigger gun, quickly move gun to redirect spray into waste pail. Continue triggering gun into waste pail until flushing fluid dispensed from gun is relatively clear.

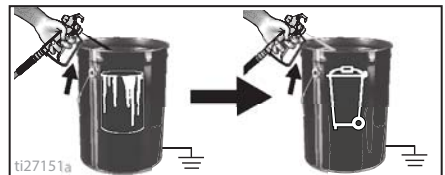

- Turn pressure control knob to the low-est setting.
- Stop triggering gun. Engage the trigger lock.

Cleanup

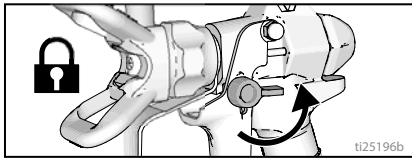

19. Turn Prime/Spray valve down to PRIME position.

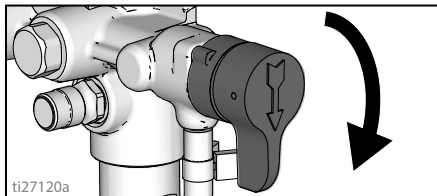

20. Turn ON/OFF switch to OFF position.

Cleaning InstaClean™ Fluid Filter (ProX only)

The InstaClean Fluid Filter prevents particles from entering paint hose. After each use, remove and clean it to ensure peak performance.

1. Perform **Pressure Relief Procedure**, page 13.
2. Disconnect airless spray hose (A) from sprayer.
3. Unscrew outlet fitting (B).
4. Remove InstaClean Fluid Filter (C).

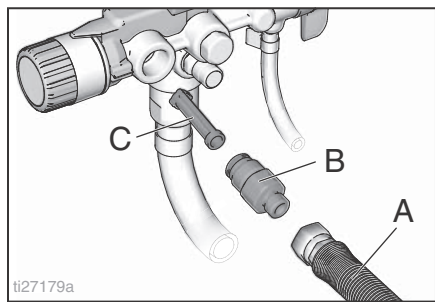

5. Check InstaClean Fluid Filter (C) for debris. If needed, clean filter with water or flushing fluid and a soft brush.

- a. Install closed (square) end of InstaClean Fluid Filter (C) in sprayer.
 - b. Screw outlet fitting (B) into sprayer.
6. Tighten outlet fitting and reconnect hose (A) to sprayer. Use two wrench to tighten securely.

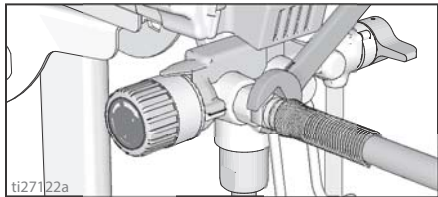

Clean the Gun

1. Clean gun fluid filter with water or flushing fluid and a brush every time you flush the system. Replace gun filter if damaged.

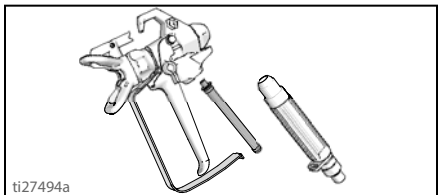

2. Remove spray tip and tip guard and clean with water or flushing fluid and a brush.

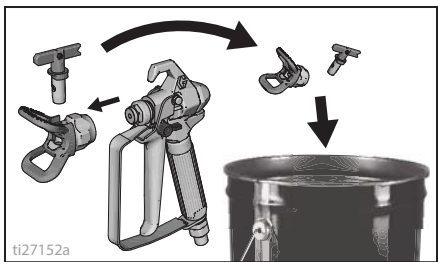

3. Wipe paint off outside of gun using a soft cloth moistened with water or flushing fluid.

Storage

With proper storage, the sprayer will be ready to use the next time it is needed.

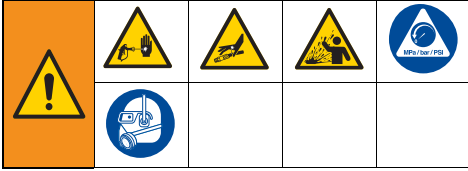

Short Term Storage

(up to 2 days)

1. Perform **Pressure Relief Procedure**, page 13.
2. Leave suction tube and drain tube in paint pail.

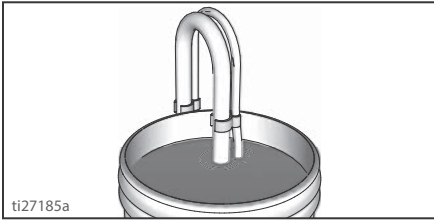

3. Cover paint and pail tightly with plastic wrap.

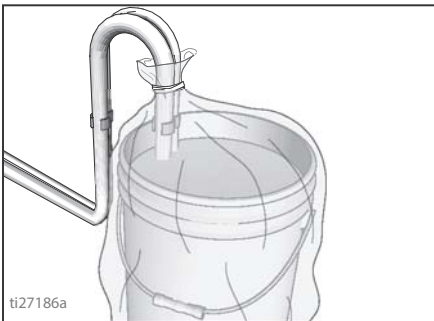

4. Engage trigger lock.

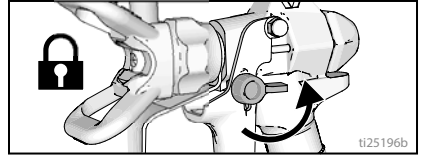

5. Leave gun attached to hose.
6. Remove tip and guard and clean with water or flushing fluid and a brush.
7. Wipe paint off outside of gun using a soft cloth moistened with water or flushing fluid.

Long Term Storage

(more than 2 days)

Pump Armor fluid protects the sprayer against freezing and corrosion.

- Before storing sprayer make sure all water is drained out of sprayer.
 - Do not allow water to freeze in sprayer.
 - Do not store sprayer under pressure.
 - Store sprayer indoors.
1. Perform **Pressure Relief Procedure**, page 13.
 2. Place suction tube in Pump Armor fluid bottle and drain tube in waste pail.

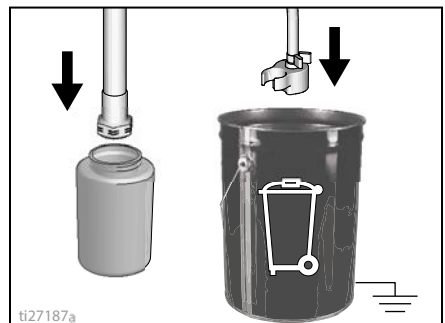

Storage

3. Turn Prime/Spray valve down to **PRIME** position.

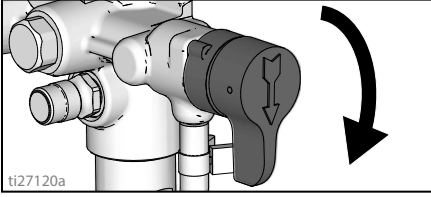

4. Turn ON/OFF switch to **ON** position.
5. Turn pressure control knob clockwise until the pump turns on.
6. When storage fluid comes out of drain tube (5-10 seconds) turn ON/OFF switch to **OFF** position.
7. Turn Prime/Spray valve horizontal to **SPRAY** position to keep storage fluid in sprayer during storage.

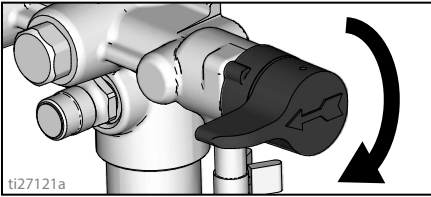

8. Leave gun attached to hose.
9. Remove tip and guard and clean with water or flushing fluid and a brush.
10. Wipe paint off outside of gun using a soft cloth moistened with water or flushing fluid.

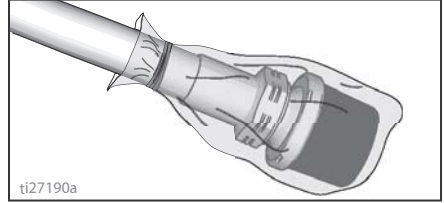

11. Secure a plastic bag around suction and drain tube to catch any drips.

Reference

Spray Tip Selection

Selecting Tip Size

Spray tips come in a variety of hole sizes for spraying a range of fluids. Your sprayer includes a tip for use in most paint spraying applications. Use the coatings table on page 17 to determine the range of recommended tip hole sizes for each fluid type. If you need a tip other than the one supplied, see the **Reversible Spray Tip Selection Chart**, page 25.

Hints:

- As you spray, the tip wears and enlarges. Starting with a tip hole size smaller than the maximum will allow you to spray within the rated flow capacity of the sprayer.
- Use larger tip hole sizes with thicker coatings and smaller tip hole sizes with thinner coatings.
- Tips wear with use and need periodic replacement.
- Tip hole size controls flow rate - the amount of paint that comes out of the gun.

Fan Width

Fan width is the size of the spray pattern, which determines the area covered with each stroke.

Hints:

- Select a fan width best suited to the surface being sprayed.
- Wider fans allow provide better coverage on broad, open surfaces.
- Narrower fans provide better control on small, confined surfaces.

Understanding Tip Number

The last three digits of tip number (i.e.: 221413) contain information about hole size and fan width on surface when gun is held 12 in. (30.5 cm) from surface being sprayed.

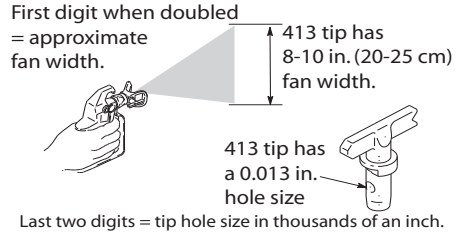

Reversible Spray Tip Selection Chart







Tip Part #	Fan Width *	Hole Size
221311	6 - 8 in. (152 - 203 mm)	0.011 in. (0.28 mm)
221411	8 - 10 in. (203 - 254 mm)	0.011 in. (0.28 mm)
221313	6 - 8 in. (152 - 203 mm)	0.013 in. (0.33 mm)
221413	8 - 10 in. (203 - 254 mm)	0.013 in. (0.33 mm)
221415	8 - 10 in. (203 - 254 mm)	0.015 in. (0.38 mm)
221515	10 - 12 in. (254 - 305 mm)	0.015 in. (0.38 mm)
221417	8 - 10 in. (203 - 254 mm)	0.017 in. (0.43 mm)
221517	10 - 12 in. (254 - 305 mm)	0.017 in. (0.43 mm)
221619	12 - 14 in. (305 - 356 mm)	0.019 in. (0.48 mm)
221521	10 - 12 in. (254 - 305 mm)	0.021 in. (0.53 mm)
* - 12 in. (305 mm) from surface		

Example: For an 8 to 10 in. (203 to 254 mm) fan width and 0.013 (0.33 mm) hole size, order Part No. 221413.

Lacquer Conversion Kit

To spray lacquers with the ProX17 or ProX19, you must purchase a lacquer conversion kit, and follow **Static Grounding Instructions (Oil-Based materials)**, page 26, when using oil-based materials. See ProX17 and ProX19 parts list, page 41 or 45. The X5 and X7 must not be used with lacquers.

Cleaning Fluid Compatibility





				
				

Oil- or Water-Based Materials

- When spraying **water-based** materials, flush the system thoroughly with water.
- When spraying **oil-based** materials, flush the system thoroughly with mineral spirits or compatible, oil-based flushing solvent.
- To spray **water-based** materials **after spraying oil-based** materials, flush the system thoroughly with water first. The water flowing out of drain tube should be clear and solvent-free **before** you begin spraying the water-based material.
- To spray **oil-based** materials **after spraying water-based** materials, flush the system thoroughly with mineral spirits or a compatible oil-based flushing solvent first. The solvent flowing out of the drain tube should not contain any water. When flushing with solvents always follow **Static Grounding Instructions (Oil-Based materials)**, page 26.

- To avoid fluid splashing back on your skin or into your eyes, always aim gun at inside wall of pail.

Static Grounding Instructions (Oil-Based materials)

				
<p>The equipment must be grounded to reduce the risk of static sparking and electric shock. An electric or static spark can cause fumes to ignite or explode. An improper ground can cause electric shock. A good ground provides an escape wire for the electric current.</p>				

Always use a metal pail for oil-based materials requiring flushing with compatible oil-based flushing solvents when sprayer is flushed or pressure is relieved.

Follow local code. Use only conductive metal pails, placed on a grounded surface such as concrete.

Do not place pail on a non-conductive surface such as paper or cardboard which interrupts grounding continuity.

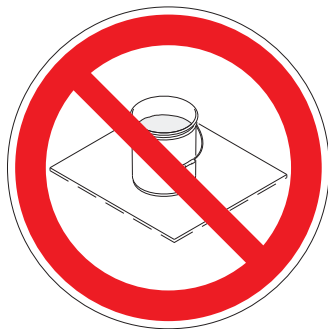

Always ground a metal pail: connect a ground wire to the pail. Clamp one end to the pail and the other end to a true earth ground such as a water pipe.

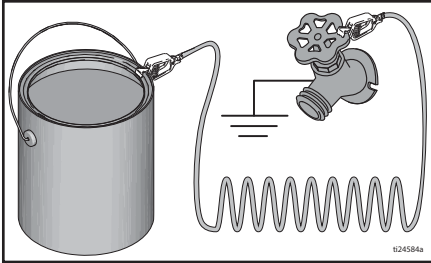

To maintain ground continuity when sprayer is flushed or pressure is relieved: hold metal part of spray gun firmly to the side of a grounded metal pail, then trigger the gun.

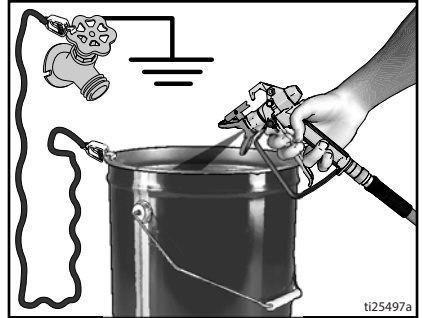

Quick Reference

Page 10	Name	Description
A	Prime/Spray Valve	<ul style="list-style-type: none"> In PRIME position directs fluid to drain tube. In SPRAY position directs pressurized fluid to paint hose. Automatically relieves system pressure in over-pressure situations.
B	PushPrime Button	Taps the inlet ball when pushed to loosen it.
C	Pressure Control Knob	Increases (clockwise) and decreases (counter-clockwise) fluid pressure in pump, hose, and spray gun. To select function, align symbol on pressure control knob with setting indicator, page 13.
D	ON/OFF Switch	Turns sprayer ON and OFF.
E	Suction Tube	Draws fluid from paint pail into pump.
F	Drain Tube	Drains fluid in system during priming and pressure relief.
G	Airless Spray Gun	Dispenses fluid.
H	Reversible Spray Tip	<ul style="list-style-type: none"> Atomizes fluid being sprayed, forms spray pattern and controls fluid flow according to hole size. Reverse position unclogs plugged tips without disassembly.
J	Tip Guard	Reduces risk of fluid injection injury.
K	Gun Trigger Lock	Prevents accidental triggering of spray gun.
L	Gun Fluid Inlet Fitting	Threaded connection for paint hose.
M	Gun Fluid Filter	Filters fluid entering spray gun to reduce tip clogs.
N	Pump	Pumps and pressurizes fluid and delivers it to paint hose.
P	Pump Fluid Outlet Fitting	Threaded connection for airless hose.
Q	Airless Hose	Transports high-pressure fluid from pump to spray gun.
R	InstaClean™ Fluid Filter (ProX only)	<ul style="list-style-type: none"> Filters fluid coming out of pump to reduce tip plugging and improve finish. Self cleans only during pressure relief.
S	Pail Hanger	For transporting pail by its handle.
T	Inlet Strainer	Prevents debris from entering pump.
U	Power Cord	Plugs into power source.
V	Easy Access Door (ProX only)	Easy Access Door permits quick access to the pump. Open pump door by pulling out on the tabs while sliding door up.
W	Suction Tube Drip Cup	Holds the suction tube during transport to catch drips.
X	Pump Removal Tool (ProX only)	Cut out in the frame provide the tools to quickly remove the pump packing without additional tools.
Z	Inlet Valve Removal Tool (ProX only)	Cut out in the frame provide the tools to quickly remove the inlet valve without additional tools.
	Power Flush Attachment	Connects garden hose to suction tube for power flushing water-based fluids.

Maintenance

Routine maintenance is important to ensure proper operation of your sprayer.



Activity	Interval
Inspect motor shroud openings for blockage.	Daily or each time you spray
Inspect/clean InstaClean filter (ProX only), fluid inlet strainer, and gun filter.	Daily or each time you spray

NOTICE

Protect the internal drive parts of this sprayer from water. Openings in shroud allow cooling of mechanical parts and electronics inside. If water gets into these openings, the sprayer could malfunction or be permanently damaged.

Airless Hoses

Check hose for damage every time you spray. Do not attempt to repair hose if hose jacket or fittings are damaged. Do not use hoses shorter than 25 ft (7.6 m). Wrench tighten, using two wrenches.

Spray Tips

- Always clean tips with compatible cleaning fluid and brush after spraying.
- Tips may require replacement after 15 gallons (57 liters) or they may last through 60 gallons (227 liters) depending on abrasiveness of paint.

Pump Repair (ProX Only)

When pump packings wear, paint will begin to leak down outside of pump. Each time the pump kit is replaced, check pump inlet and outlet valves for wear or damage. Replace if worn or damaged. Always replace inlet and outlet valves every second time the pump kit is replaced.

- See **ProXChange Pump (ProX only)**, page 48 or consult a Graco/MAGNUM authorized retailer, distributor, or service center.
- Purchase a pump repair kit and install according to instructions provided with kit, before your next job.

Pump Removal

Remove the hopper on sprayers with a hopper. Remove airless hose, it may also be necessary to remove the suction tube.

Always perform **Pressure Relief Procedure**, page 13 before starting any pump repairs and unplug the sprayer.

1. Unplug the sprayer from the power source.
2. Pull tabs on sides of the easy access door towards you while pushing the entire door away from the inlet end of the pump.
3. Now lift the door so that it swivels out of the way.

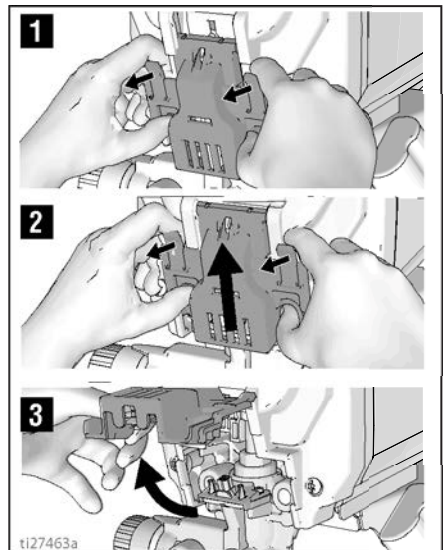

Maintenance

- Slide pump assembly off the mounting pins.

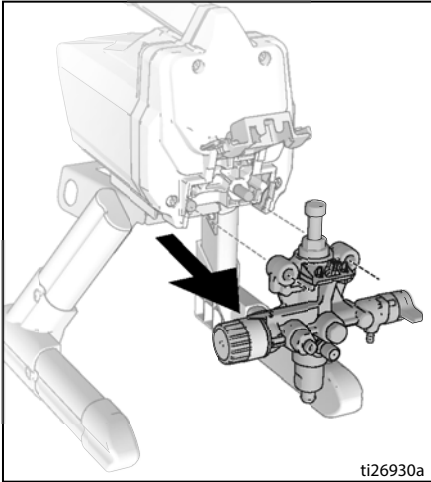

ProXChange Removal Tool

An integrated tool is included in the frame to remove the ProXChange packing assembly. See Pump repair manual for complete repair instructions.

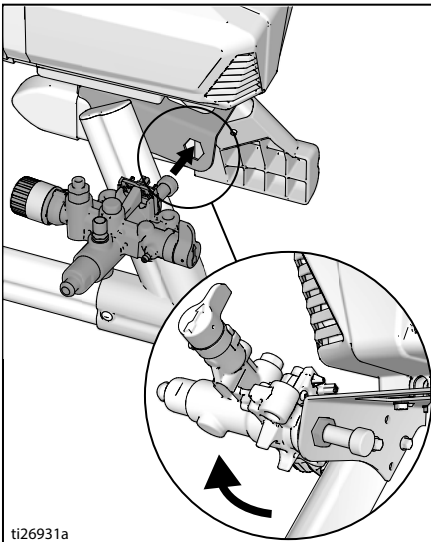

Inlet Valve Removal

An integrated tool is included in the frame to remove the inlet valve assembly from the pump. If you suspect that the inlet valve is clogged or stuck, remove the valve assembly and clean or replace.

- Remove suction tube or hopper from sprayer.
- Insert pump inlet into frame and loosen the inlet valve. Remove inlet valve.

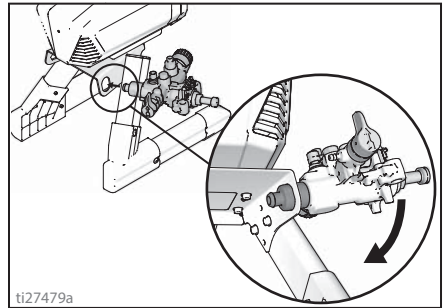

NOTICE

Do not lose the ball and spring inside the inlet valve assembly. It may fall out when the inlet valve is removed. Pump will not prime without the ball and spring.

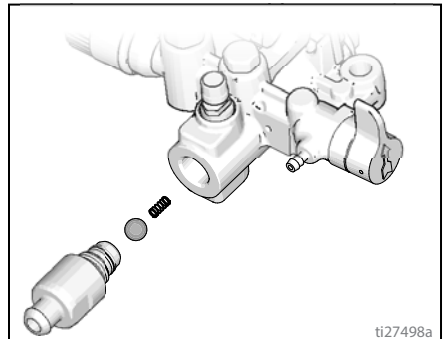

- Clean any debris and dried paint from the cavity and replace the ball and spring. Tighten inlet valve to pump using integrated tool on the frame.

Pump Installation

1. Slide pump assembly onto the mounting pins.

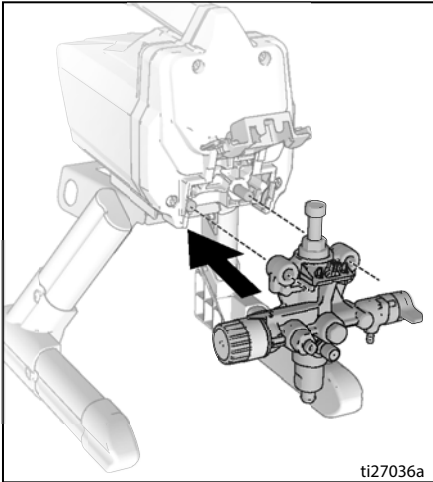

- a. Move pump rod up or down until cap is level with the opening in the yoke.

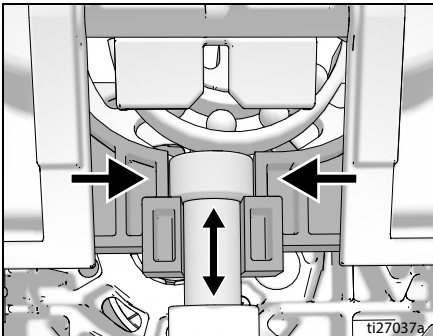

- b. Push on pump rod to slide pump assembly back on to mounting pins.
2. Swing easy access door closed while pushing the entire door towards the inlet end of the pump.

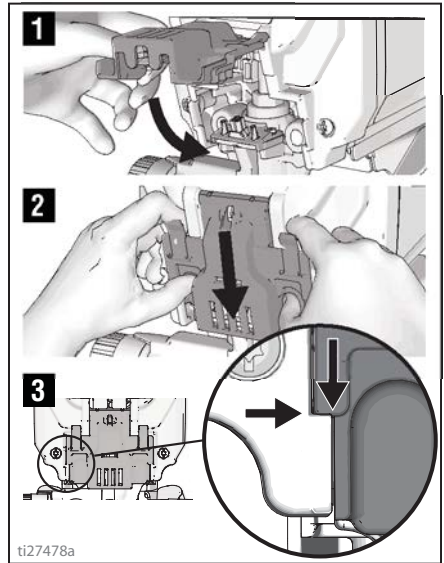

3. Install hopper if it was removed and any hoses removed earlier.
4. Plug sprayer into power source.

NOTE: Door must be fully closed and latched before sprayer will operate.

Troubleshooting

3. Check everything in this Troubleshooting Table before you bring the sprayer to an authorized service center.

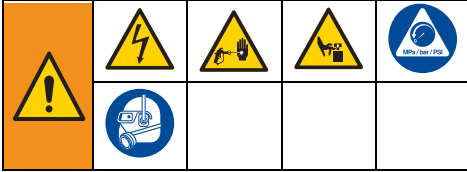

1. Follow **Pressure Relief Procedure**, page 13, before checking or repairing.
2. Solutions at the beginning of each problem listed are the most common.

Have a Question?

Call toll-free:
1-888-541-9788
 Or visit us at:
www.magnum.graco.com

ti24021a

Problem	Cause	Solution
Motor does not run: (verify sprayer is plugged in, and ON/OFF switch is on)	ProX only: Easy access door not fully closed.	Verify that easy access door is closed and latched. See page 31.
	Pressure control is set at zero pressure.	Turn pressure control knob clockwise to increase pressure setting.
	Electric outlet is not providing power.	Test outlet with known working device. Reset circuit breaker or replace fuse. Find working outlet. Reset building circuit breaker or replace fuse.
	Extension cord is damaged.	Replace extension cord. See page 4.
	Sprayer electric cord is damaged.	Check for broken insulation or wires. Replace electric cord if damaged.
	Pump is seized (Paint has hardened in pump or Water is frozen in pump.)	Turn ON/OFF switch off and unplug sprayer from outlet. If frozen do NOT try to start sprayer until it is completely thawed or it may damage the motor, control board and/or drive train. Place sprayer in warm area for several hours. Check for free moving pump by removing shroud and spinning fan. If not frozen, check for hardened paint in pump. If paint has hardened in pump. See page 29. If motor does not turn with pump removed, consult a Graco/ Magnum authorized retailer, distributor, or service center.
Motor or control is damaged.	Consult a Graco/ Magnum authorized retailer, distributor, or service center.	

Problem	Cause	Solution
<p>Sprayer runs, but pump does not prime or loses prime while in use. (Pump cycles but does not pump paint or build pressure.)</p>	Inlet valve check ball is stuck.	Press PushPrime button to dislodge the ball allowing pump to prime properly, OR Power Flush sprayer, see page 20.
	Prime/Spray valve is in SPRAY position.	Turn Prime/Spray valve down to PRIME position until paint exits drain tube. The pump is now primed.
	Pump was not primed with flushing fluid. (Thick fluids may not prime if not initially primed with flushing fluid.)	Remove suction tube from paint. Prime pump with oil or water-based flushing fluid. See page 26.
	Debris in paint.	Strain the paint. See page 12.
	Thick or “sticky” paint.	Some fluids may prime faster if the ON/OFF switch is momentarily turned off so the pump can slow and stop. Turn ON/OFF switch on and off several times if necessary.
	Inlet strainer is clogged or suction tube is not immersed in paint.	Clean debris off inlet strainer and make sure suction tube is immersed in paint.
	Inlet valve check ball or seat is dirty.	Remove inlet fitting. Clean or replace ball and seat. ProX only: See page 30.
	Suction tube is leaking.	Inspect suction tube connection for cracks or vacuum leaks.
	Outlet valve check ball is stuck.	Unscrew outlet valve, remove, and clean assembly.
	Prime/Spray valve is worn or obstructed with debris.	Take sprayer to Graco/MAGNUM authorized service center.

Troubleshooting

Problem	Cause	Solution
Pump is primed, but can not achieve good spray pattern.	Spray tip may be partially clogged.	Clear spray tip clog. See page 18.
	Reversible spray tip is in UNCLOG position.	Rotate arrow-shaped handle on spray tip so it points forward to SPRAY position. See page 18.
	Debris in paint.	Strain the paint. See page 26.
	Pressure is set too low.	Align pressure control knob setting indicator to desired spray setting. See page 17.
	ProX only: InstaClean fluid filter is clogged.	Clean or replace InstaClean fluid filter. See page 22.
	Spray gun fluid filter is clogged.	Clean or replace gun fluid filter. See page 22.
	Spray tip selected is too large for capability of sprayer.	Replace tip. See page 17.
	Spray tip is worn beyond the capability of sprayer.	Replace tip. See page 17.
	Spray tip gasket and seal worn or missing.	Replace gasket and seal. See page 16.
	Inlet strainer is clogged or suction tube is not immersed in paint.	Clean debris off inlet strainer and make sure suction tube is immersed in paint.
	Extension cord is too long or not heavy enough gauge.	Replace extension cord. See page 4.
	Inlet pump valve or outlet pump valve is worn or clogged with debris.	<p>Check for worn or contaminated inlet valve or outlet valve.</p> <ul style="list-style-type: none"> - Prime sprayer with paint - Trigger gun momentarily - When trigger is released, pump should cycle momentarily and stop - If pump continues to cycle, pump valves may be worn or contaminated with debris - Clean and reinstall valves - ProX only: Replace valves with appropriate kits. See page 48.
	Material is too thick.	Thin material. Follow manufacturers recommendations.
Airless hose is too long (if extra section was added).	Remove section of airless hose.	
Spray gun stopped spraying while trigger is pulled.	Spray tip is clogged.	Clear spray tip clog. See page 18.
	Sprayer lost prime.	See troubleshooting section "Sprayer runs, but pump does not prime or loses prime while in use." on page 33.

Problem	Cause	Solution
When paint is sprayed, it runs down the wall or sags.	Material is going on too thick.	Move gun faster.
		Choose a spray tip with smaller hole size.
		Choose spray tip with wider fan.
		Make sure gun is far enough from surface.
When paint is sprayed, coverage is inadequate.	Material is going on too thin.	Move gun slower.
		Choose spray tip with larger hole size.
		Choose spray tip with narrower fan.
		Make sure gun is close enough to surface.
Fan pattern varies dramatically while spraying.	Pressure control switch is worn and causing excessive pressure variation.	Take sprayer to Graco/MAGNUM authorized service center.
Cannot trigger spray gun.	Spray gun trigger lock is engaged.	Rotate trigger lock to disengage trigger lock. See page 12.
Paint is coming out of pressure control switch.	Pressure control switch is worn.	Take sprayer to Graco/MAGNUM authorized service center.
Paint is leaking through drain tube.	Sprayer is over pressurizing.	Take sprayer to Graco/MAGNUM authorized service center.
Paint leaks down outside of pump.	Pump packings are worn.	Replace pump packings ProX only: Replace pump packings with new ProXChange module. See page 29.
Motor is hot and runs intermittently. Motor automatically shuts off due to excessive heat. Damage can occur if cause is not corrected.	Vent holes in enclosure are plugged or sprayer is covered.	Keep vent holes clear of obstructions and overspray and keep sprayer open to air.
	Extension cord is too long or not a heavy enough gauge.	Replace extension cord. See page 4.
	Unregulated electrical generator being used has excessive voltage.	Use electrical generator with a proper voltage regulator.
	Motor needs to be replaced.	Take sprayer to Graco/Magnum authorized retailer, distributor, or service center.

X5: 262800, 17K437 Stand Sprayer Parts

X5: 262800, 17K437 Stand Sprayer Parts

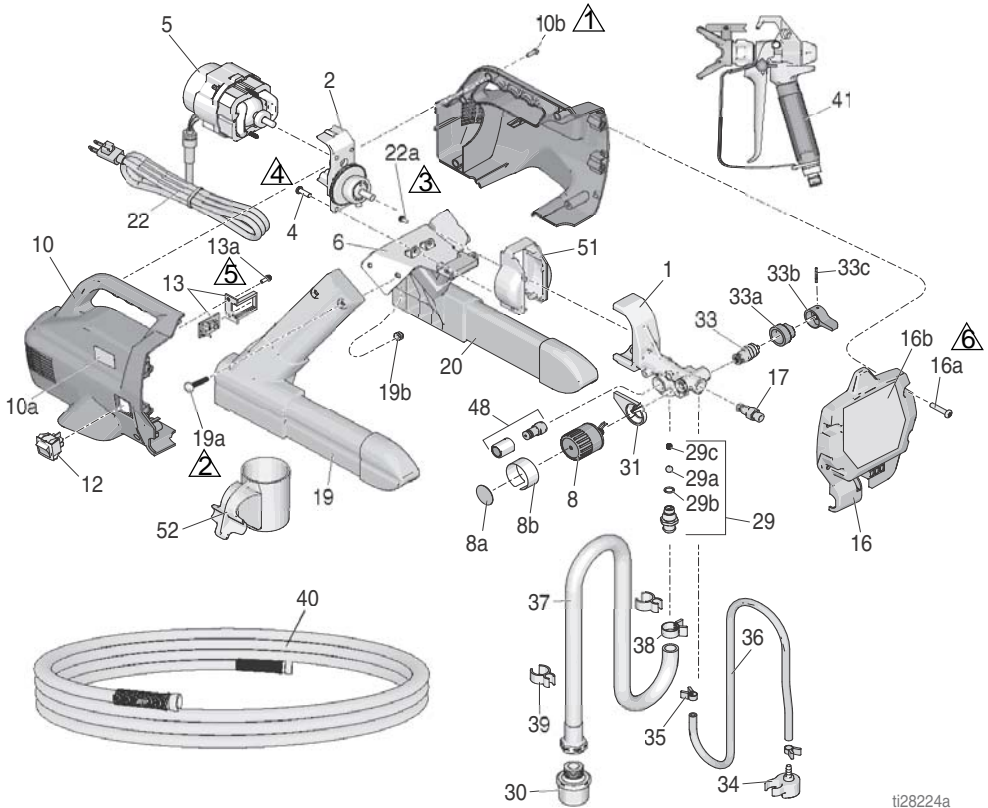

ti28224a

Ref.	Torque
▲1	20-25 in-lb (2.3-2.8 N•m)
▲2	26-32 in-lb (2.9-3.6 N•m)
▲3	25-35 in-lb (2.8-4.0 N•m)
▲4	80-90 in-lb (9.0-10.0 N•m)
▲5	12-16 in-lb (1.4-1.8 N•m)
▲6	36-42 in-lb (4.0-4.7 N•m)

X5: 262800, 17K437 Stand Sprayer Parts

262800, 17K437 Stand Sprayer Parts List

Ref. Part	Description	Qty.	Ref. Part	Description	Qty.
1	17L079 KIT, pump <i>includes 4, 8, 17, 29, 33, 48</i>	1	29b	103338 O-RING	1
2	16E835 DRIVE	1	29c	123849 SPRING, inlet	1
4	112689 SCREW, button, thd form	4	30	288716 KIT, strainer	1
5	17L282 KIT, motor	1	31	15Y296 COVER, wire	1
6	16D682 BRACKET, motor	1	33	235014 KIT, drain valve <i>includes 33a, 33b, 33c</i>	1
8	244267 KIT, pressure control <i>includes 8a, 8b</i>	1	33a	24E578 BASE, valve	1
8a	15A464 LABEL, control	1	33b	187625 HANDLE, valve, drain	1
8b	15K530 LABEL, control	1	33c	111600 PIN, grooved	1
10	17K541 KIT, enclosure, X5 <i>includes 10a, 10b, 16a</i>	1	34	244035 DEFLECTOR, barbed	1
10a	17K516 LABEL, A+ service	1	35	115489 CLAMP, drain tube	2
10b	115477 SCREW, mach, torx, pan hd	4	36	195084 TUBE, drain	1
12	118899 SWITCH, rocker, spdt	1	37	24V074 KIT, tube, suction <i>includes 30, 34, 35, 36, 38, 39, 61</i>	1
13	17L104 KIT, control board <i>includes 13a</i>	1	38	116295 CLAMP, tube	1
13a	115477 SCREW, mach, torx	1	39	195400 CLIP, spring	2
16	17L085 KIT, housing cover <i>includes 16a, 16b</i>	1	40	247339 HOSE, cpld, 14 in. x 25 ft	1
16a	120724 SCREW	4	41	GUN, spray, SG2	
16b	17J963 LABEL, Magnum X5, front	1		243011 Model 262800	1
17	16E845 KIT, outlet valve, X5 and X7	1		257359 Model 17K437	1
19	24K632 KIT, right leg, X5 <i>includes 2 screws, 19a, 19b</i>	1	48	17L086 KIT, push prime	1
19a	125116 BOLT, carriage	4	51	16W319 COVER, gear	1
19b	102040 NUT, lock, hex	4	52	17H422 CUP, inlet drip	1
20	24K633 KIT, left leg, X5 <i>includes 2 screws, 19a, 19b</i>	1	60	3A3526 GUIDE, Magnum quick guide, English (not shown)	1
22	16E842 KIT, power cord, X5 <i>includes 22a, 22b</i>	1	60a	3A3528 GUIDE, Magnum quick guide, Spanish (not shown)	1
22a	115498 SCREW, grounding	1	61	115648 VALVE, power flush (not shown)	1
22b	17K627 LABEL, Magnum, warning (not shown)	1	62	244168 FLUID, pump armor, 8 oz (not shown)	1
▲			63▲	222385 CARD, medical wallet (not shown)	1
29	16E844 KIT, pump, inlet valve <i>includes 29a, 29b, 29c</i>	1	64	17K631 TAG, hang, tip (not shown)	1
29a	124249 BALL, intake	1			

▲ Replacement Danger and Warning labels, tags, and cards are available at no cost.

X7: 262805 Cart Sprayer Parts

X7: 262805 Cart Sprayer Parts

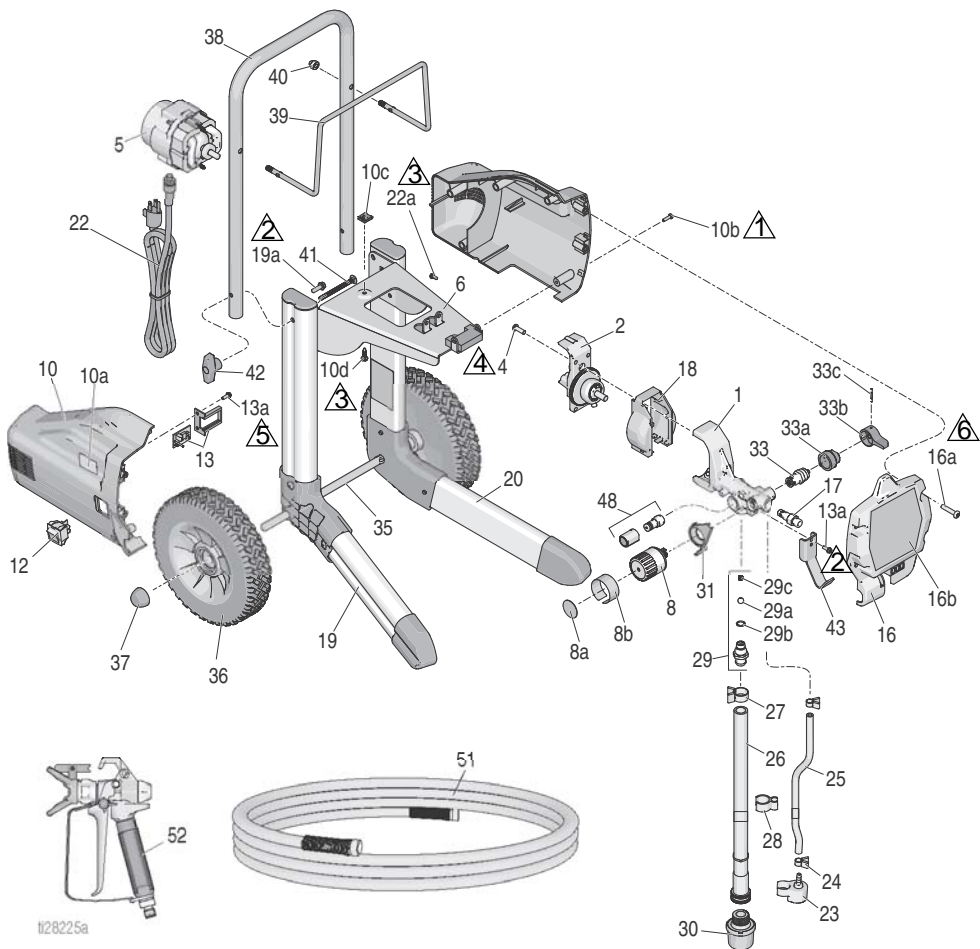





Ref.	Torque
1	20-25 in-lb (2.3-2.8 N•m)
2	45-55 in-lb (5.0-6.2 N•m)
3	25-35 in-lb (2.8-4.0 N•m)
4	80-90 in-lb (9.0-10.0 N•m)
5	12-16 in-lb (1.4-1.8 N•m)
6	36-42 in-lb (4.0-4.7 N•m)

X7: 262805 Cart Sprayer Parts

262805 Cart Sprayer Parts List

Ref. Part	Description	Qty.	Ref. Part	Description	Qty.
1	17L079 KIT, pump <i>includes 4, 8, 17, 29, 33, 48</i>	1	27	116295 CLAMP, tube	1
2	16E835 KIT, drive	1	28	195400 CLIP, spring	2
4	112689 SCREW, button, thd form	4	29	16E844 KIT, pump, inlet valve (includes 29a, 29b, 29c)	1
5	17L282 KIT, motor	1	29a	124249 BALL, intake	1
6	16D683 BRACKET, motor	1	29b	103338 O-RING	1
8	244267 KIT, pressure control <i>includes 8a, 8b</i>	1	29c	123849 SPRING, inlet	1
8a	15A464 LABEL, control	1	30	288716 KIT, strainer	1
8b	15K530 LABEL, control	1	31	15Y296 COVER, wire	1
10	17K542 KIT, enclosure, X7 <i>includes 10a, 10b, 10c, 10d, 16a</i>	1	33	235014 KIT, drain valve <i>includes 33a, 33b, 33c</i>	1
10a	17K516 LABEL, A+ service	1	33a	24E578 BASE, valve	1
10b	115477 SCREW, mach, torx, pan hd	4	33b	187625 HANDLE, valve, drain	1
10c	121481 NUT, U-type, tinnerman	1	33c	111600 PIN, grooved	1
10d	120093 SCREW, self drilling	1	35	15R602 AXLE, cart	1
12	118899 SWITCH, rocker, spdt	1	36	115095 WHEEL, 9 in.	2
13	17L104 KIT, control board <i>includes 13a</i>	1	37	112612 CAP, hub	2
13a	115477 SCREW, mach, torx	3	38	16H354 HANDLE, cart	1
16	17L085 KIT, housing cover <i>includes 16a, 16b</i>	1	39	16H350 RACK, hose	1
16a	120724 SCREW	4	40	120689 NUT, hex, acorn, 5/16-18 nickel	2
16b	17J966 LABEL, Magnum X7, front	1	41	120788 SCREW, carriage	2
17	16E845 KIT, outlet valve	1	42	115480 KNOB, t-handle	2
18	16W319 COVER, gear	1	43	16D907 HANGER, pail	1
19	17L088 KIT, right leg, X7 <i>includes 3 screws, 19a</i>	1	48	17L086 KIT, push prime	1
19a	260212 SCREW, hex washer	4	51	247339 HOSE, cpld, 14 in. x 25 ft	1
20	17L087 KIT, left leg, X7 <i>includes 3 screws, 19a</i>	1	52	243011 GUN, spray, SG2	1
22	16E843 KIT, power cord, X7 <i>includes 22a, 22b</i>	1	60	3A3526 GUIDE, Magnum quick guide, English (not shown)	1
22a	115498 SCREW, grounding	1	60a	3A3528 GUIDE, Magnum quick guide, Spanish (not shown)	1
22b	17K627 LABEL, Magnum, warning (not shown)	1	61	115648 VALVE, power flush (not shown)	1
▲			62	244168 FLUID, pump armor, 8 oz (not shown)	1
23	244035 DEFLECTOR, barbed	1	63▲	222385 CARD, medical wallet (not shown)	1
24	115489 CLAMP, drain tube	2	64	17K631 TAG, hang, tip (not shown)	1
25	195108 TUBE, drain	1	▲ Replacement Danger and Warning labels, tags, and cards are available at no cost.		
26	24V073 KIT, suction tube <i>includes 23, 24, 25, 27, 28, 30, 61</i>	1			

ProX17: 17G177, 17K438, ProX19: 17G179 Stand Sprayer Parts

Ref.	Torque
	140-160 in-lb (16-18 N•m)
	30-35 in-lb (3.5-4.0 N•m)
	110-120 in-lb (12-14 N•m)
	45-55 in-lb (5-6 N•m)

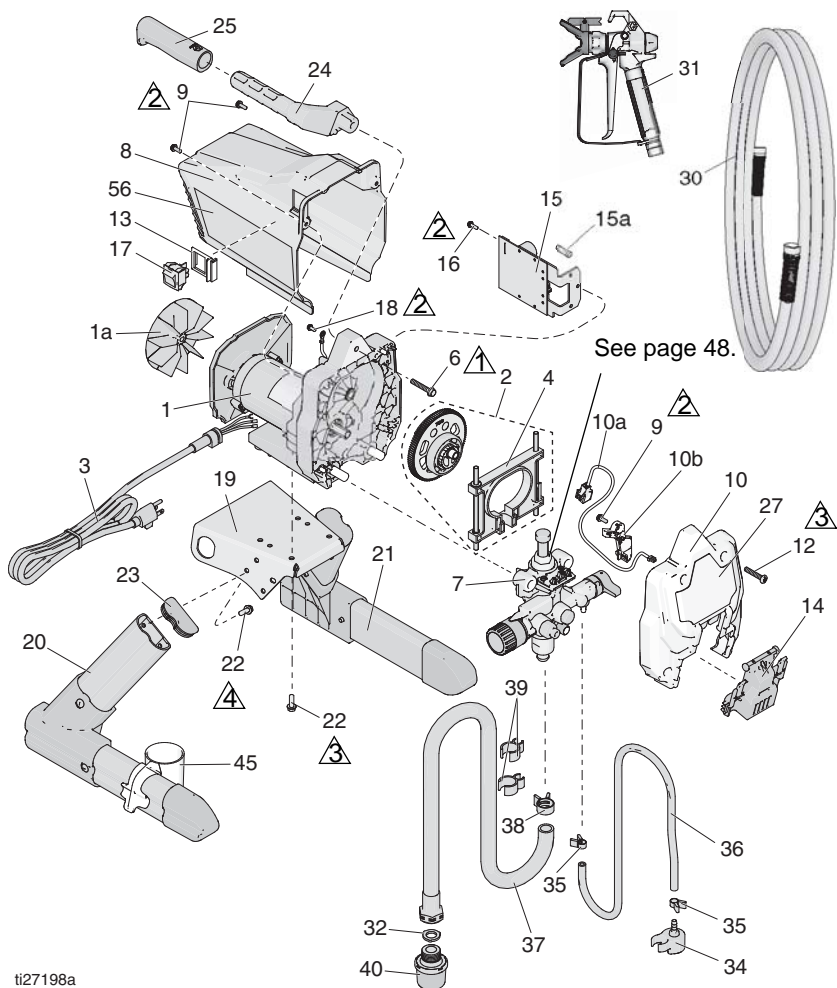

ti27198a

ProX17: 17G177, 17K438, ProX19: 17G179



17G177, 17K438, 17G179 Stand Sprayer Parts List

Ref. Part	Description	Qty.	Ref. Part	Description	Qty.
1	KIT, repair, motor, 120V <i>includes 1a</i>		17J031	ProX17	1
	17K285	1	17J033	ProX19	1
	17F756	1	30 247340	HOSE, cpld, 1/4 in. x 50 ft	1
1a	287770	1	31	GUN, spray, SG3	
2	17J863	1	243012	Models 17G177, 17G179	1
3	17J173	1	246506	Models 17K438,	1
4	17J864	1	32 115099	WASHER, hose	1
6	117493	1	34 244035	DEFLECTOR, barbed	1
	SCREW, mach, hex, washer head		35 115489	CLAMP, drain tube	2
7	17J874	1	36 195084	TUBE, drain	1
8	17J865	1	37 24V074	KIT, tube, suction <i>includes 34, 35, 36, 38, 39, 40</i>	1
9	118444	3			
	SCREW, mach, hwhd 10-24 x 0.5 in.		38 116295	CLAMP, tube	1
10	17J866	1	39 195400	CLIP, spring	2
	COVER, front <i>includes 9, 10a, 10b, 12, 14</i>		40 288716	KIT, strainer	1
10a	128551	1	45 17H422	CUP, suction/drain	1
10b	17F262	1	56▲ 17J027	LABEL, warning	1
12	115478	4	57▲ 222385	CARD, medical alert (not shown)	1
	SCREW, mach, Torx, pan hd		60 3A3526	GUIDE, Magnum quick guide, English (not shown)	1
13	15J803	1			
	SWITCH, bracket		60a 3A3528	GUIDE, Magnum quick guide, Spanish (not shown)	1
14	17F233	1	61 115648	VALVE, power flush (not shown)	1
	COVER, pump, locking		62 244168	FLUID, pump armor, 8 oz (not shown)	1
15	17J867	1	64 17K631	TAG, hang, tip (not shown)	1
	KIT, control board 120V <i>includes 15a, 16</i>				
15a	119276	1	17L305	KIT, conversion, lacquer, stand (sold separate)	
	FUSE, 12.5A slow blow				
16	117501	1			
17	24Y329	1			
	KIT, switch, repair <i>includes 13</i>				
18	115498	1			
	SCREW, mach, slot, hex whd				
19	17G328	1			
20	16D686	1			
21	16D687	1			
22	260212	8			
	SCREW, hwh, thread forming				
23	15J599	2			
24	276864	1			
25	116139	1			
27	LABEL, front				

▲ Replacement Danger and Warning labels, tags, and cards are available at no cost.

ProX21: 17G181 Stand Sprayer Parts

ProX21: 17G181 Stand Sprayer Parts

Ref.	Torque
	140-160 in-lb (16-18 N•m)
	30-35 in-lb (3.5-4.0 N•m)
	110-120 in-lb (12-14 N•m)

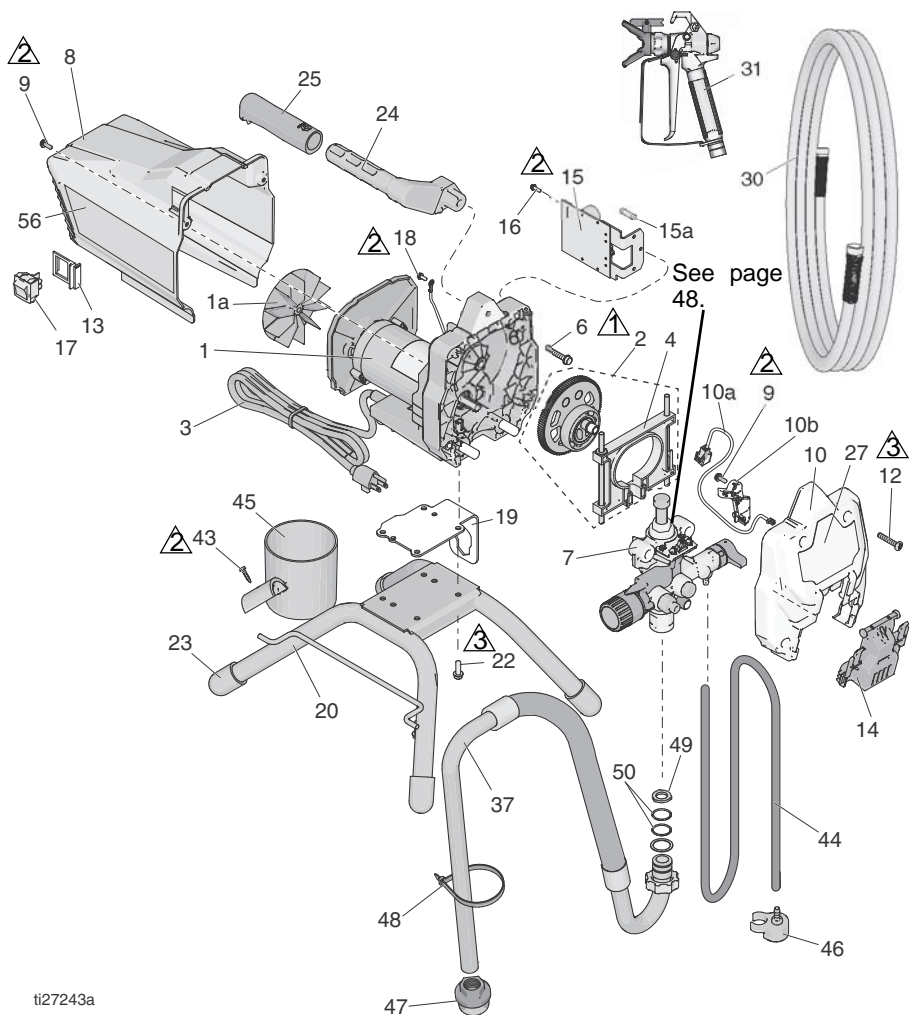

ti27243a

ProX21: 17G181 Stand Sprayer Parts



17G181 Stand Sprayer Parts List

Ref. Part	Description	Qty.	Ref. Part	Description	Qty.		
1	17K684	MOTOR, 120V	1	27	17J035	LABEL, front, ProX21	1
1a	16X980	FAN	1	30	247340	HOSE, cpld, 1/4 in. x 50 ft	1
2	17J869	KIT, gear and yoke	1	31	243012	GUN, spray, SG3	1
3	17J173	CORD, power	1	37	17J870	KIT, suction set <i>includes 47, 49, 50</i>	1
4	17J864	KIT, yoke	1	43	122667	SCREW, drill, hex, washer head	1
6	117493	SCREW, mach, hex, washer head	1	44	17J884	TUBE, drain <i>includes 46</i>	1
7	17J875	KIT, pump complete	1	45	15G838	CUP, suction/drain	1
8	17K688	SHIELD, motor, blue <i>includes 9 and labels</i>	1	46	244035	DEFLECTOR, barbed	1
9	118444	SCREW, mach, hwhd 10-24 x 0.5 in.	3	47	245673	KIT, strainer	1
10	17J866	COVER, front <i>includes 9, 10a, 10b, 12, 14</i>	1	48	404989	STRAP, tie	1
10a	128551	CABLE, jumper, PC	1	49	115099	WASHER, hose	1
10b	17F262	COVER, wire	1	50	117559	O-ring	2
12	115478	SCREW, mach, Torx, pan hd	4	56▲	17J027	LABEL, warning	1
13	15J803	SWITCH, bracket	1	57▲	222385	CARD, medical alert (not shown)	1
14	17F233	COVER, pump, locking	1	60	3A3526	GUIDE, Magnum quick guide, English (not shown)	1
15	17J867	KIT, control board 120V <i>includes 15a, 16</i>	1	60a	3A3528	GUIDE, Magnum quick guide, Spanish (not shown)	1
15a	119276	FUSE, 12.5A slow blow	1	61	115648	VALVE, power flush (not shown)	1
16	117501	SCREW, plastite	1	62	244168	FLUID, pump armor, 8 oz (not shown)	1
17	24Y329	KIT, switch, repair <i>includes 13</i>	1	64	17K631	TAG, hang, tip (not shown)	1
18	115498	SCREW, mach, slot, hex whd	1				
19	17G329	PLATE, pump forming	1				
20	15E823	FRAME, standmount	1				
22	260212	SCREW, hwh, thread	4				
23	15G857	CAP, leg	4				
24	276864	HANDLE, sprayer	1				
25	116139	GRIP, handle	1				

▲ Replacement Danger and Warning labels, tags, and cards are available at no cost.

ProX17: 17G178, ProX19: 17G180, 17K439

ProX17: 17G178, ProX19: 17G180, 17K439 Cart Sprayer Parts

Ref.	Torque
	30-35 in-lb (3.5-4.0 N•m)
	110-120 in-lb (12-14 N•m)
	45-55 in-lb (5-6 N•m)

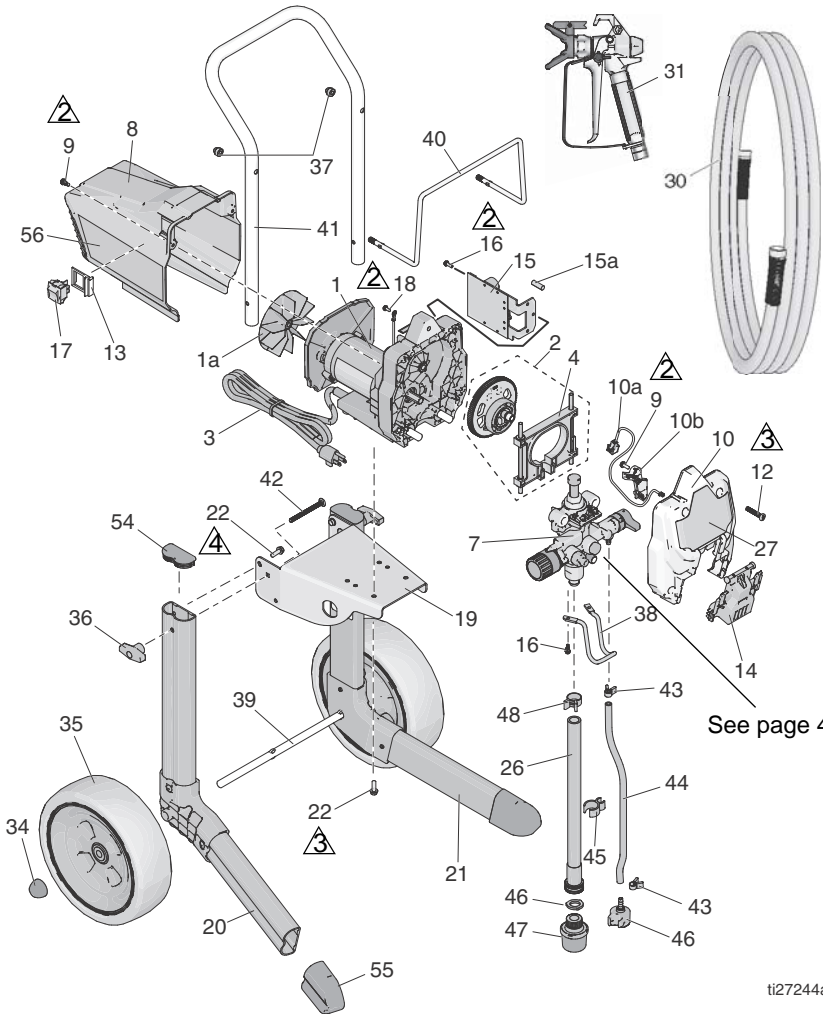

ti27244a

ProX17: 17G178, ProX19: 17G180, 17K439



17G178, 17G180, 17K439 Cart Sprayer Parts List

Ref. Part	Description	Qty.	Ref. Part	Description	Qty.	
1	MOTOR, 120V		34	112612	CAP, hub	2
	17K285 ProX17	1	35		WHEEL <i>includes 34</i>	
	17F756 ProX19	1		24Y324	ProX17	2
1a	287770 FAN	1		17K546	ProX19	2
2	17J863 KIT, gear and yoke	1	36	115480	KNOB, T-handle	2
3	17J173 CORD, power	1	37	120689	NUT, hex, acorn, 5/16-18	2
4	17J864 KIT, yoke	1	38	15J790	HOOK, pail	1
7	17J874 KIT, pump complete	1	39	16W362	AXLE, cart	1
8	17J865 SHIELD, motor, blue <i>includes 9 and labels</i>	1	40	16H350	RACK, hose	1
9	118444 SCREW, mach, hwhd 10-24 x 0.5 in.	3	41		HANDLE, cart	
10	17J866 COVER, front <i>includes 9, 10a, 10b, 12, 14</i>	1		16H354	ProX17	1
10a	128551 CABLE, jumper, PC	1		16H353	ProX19	1
10b	17F262 COVER, wire	1	42	120788	SCREW, carriage	2
12	115478 SCREW, mach, Torx, pan hd	1	43	115489	CLAMP, drain tube	1
13	15J803 SWITCH, bracket	1	44	195108	TUBE, drain	1
14	17F233 COVER, pump, locking	1	45	195400	CLIP, spring	1
15	17J867 KIT, control board 120V <i>includes 15a, 16</i>	1	46	244035	DEFLECTOR, barbed	1
15a	119276 FUSE, 12.5A slow blow	1	47	288716	STRAINER, inlet	1
16	117501 SCREW, plastite	1	48	116295	CLAMP, tube	1
17	24Y329 KIT, switch, repair <i>includes 13</i>	1	49	115099	WASHER, hose	1
18	115498 SCREW, mach, slot, hex whd	1	54	15J699	CAP, tube	2
19	17G541 PLATE, motor, mount	1	55		CAP, tube	
20	262014 ProX17	1		15J695	ProX17	2
	17K185 ProX19	1		16W505	ProX19, right	1
21	262012 ProX17	1		16W517	ProX19, left	1
	17K186 ProX19	1	56▲	17J027	LABEL, warning	1
22	260212 SCREW, hwh, thread forming	8	57▲	222385	CARD, medical alert (not shown)	1
26	24V073 TUBE, suction, assembly	1	60	3A3526	GUIDE, Magnum quick guide, English (not shown)	1
27	17J031 ProX17	1	60a	3A3528	GUIDE, Magnum quick guide, Spanish (not shown)	1
	17J033 ProX19	1	61	115648	VALVE, power flush (not shown)	1
30	247340 HOSE, cpld, 1/4 in. x 50 ft	1	62	244168	FLUID, pump armor, 8 oz (not shown)	1
31	GUN, spray, SG3		64	17K631	TAG, hang, tip (not shown)	1
	243012 Models 17G178, 17G180	1		17J873	KIT, conversion, lacquer, cart (sold separate)	
	246506 Models 17K439	1				

▲ Replacement Danger and Warning labels, tags, and cards are available at no cost.

ProX21: 17G182 Cart Sprayer Parts

ProX21: 17G182 Cart Sprayer Parts

Ref.	Torque
	30-35 in-lb (3.5-4.0 N•m)
	110-120 in-lb (12 -14 N•m)

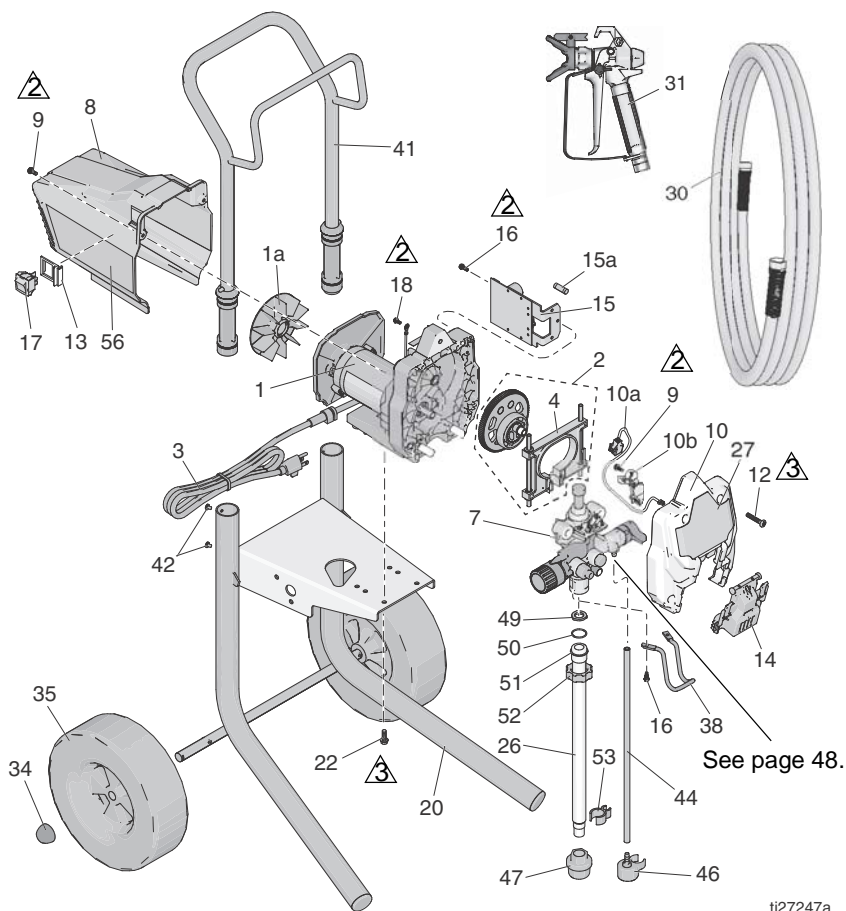

ProX21: 17G182 Cart Sprayer Parts

17G182 Cart Sprayer Parts List

Ref.	Part	Description	Qty.	Ref.	Part	Description	Qty.
1	17K684	KIT, repair, motor, 120V <i>includes 1a</i>	1	34	119452	CAP, hub	2
1a	16X980	FAN	1	35	119451	WHEEL, semi-pneumatic	2
2	17J869	KIT, gear and yoke	1	38	15J790	HOOK, pail	1
3	17J173	CORD, power	1	41	287489	HANDLE, assembly, Hi-cart	1
4	17J864	KIT, yoke	1	42	109032	SCREW, machine, pnh	4
7	17J875	KIT, pump complete	1	44	15K092	TUBE, drain	1
8	17K688	SHIELD, motor, blue <i>includes 9 and labels</i>	1	46	244035	DEFLECTOR, barbed	1
9	118444	SCREW, mach, hwhd 10-24 x 0.5 in.	3	47	288716	STRAINER, inlet	1
10	17J866	COVER, front <i>includes</i> <i>9, 10a, 10b, 12, 14</i>	1	49	115099	WASHER, hose	1
10a	128551	CABLE, jumper, PC	1	50	103413	PACKING, O-ring	1
10b	17F262	COVER, wire	1	51	15B652	WASHER, suction	1
12	115478	SCREW, mach, Torx, pan hd	1	52	15E813	NUT, jam	1
13	15J803	SWITCH, bracket	1	53	195400	CLIP, spring	1
14	17F233	COVER, pump, locking	1	56▲	17J027	LABEL, warning	1
15	17J867	KIT, control board 120V <i>includes 15a, 16</i>	1	57▲	222385	CARD, medical alert (not shown)	1
15a	119276	FUSE, 12.5A slow blow	1	60	3A3526	GUIDE, Magnum quick guide, English (not shown)	1
16	117501	SCREW, plastite	3	60a	3A3528	GUIDE, Magnum quick guide, Spanish (not shown)	1
17	24Y329	KIT, switch, repair <i>includes 13</i>	1	61	115648	VALVE, power flush (not shown)	1
18	115498	SCREW, mach, slot, hex whd	1	62	244168	FLUID, pump armor, 8 oz (not shown)	1
20	17C485	FRAME	1	64	17K631	TAG, hang, tip (not shown)	1
22	260212	SCREW, hwh, thread forming	8				
26	17J871	TUBE, suction, intake <i>includes 47, 49, 50 51, 52</i>	1				
27	17J034	LABEL, front, ProX21	1				
30	247340	HOSE, cpld, 1/4 in. x 50 ft	1				
31	243012	GUN, spray, SG3	1				

▲ Replacement Danger and Warning labels, tags, and cards are available at no cost.

ProXChange Pump (ProX only)

ProXChange Pump (ProX only)

Ref.	Torque
⚠	140-160 in-lb (16-18 N•m)
⚠	30-35 in-lb (3.4-4.0 N•m)
⚠	30-35 ft-lb (40-48 N•m)
⚠	220-250 in-lb (25-28 N•m)
⚠	320-380 in-lb (36-43 N•m)

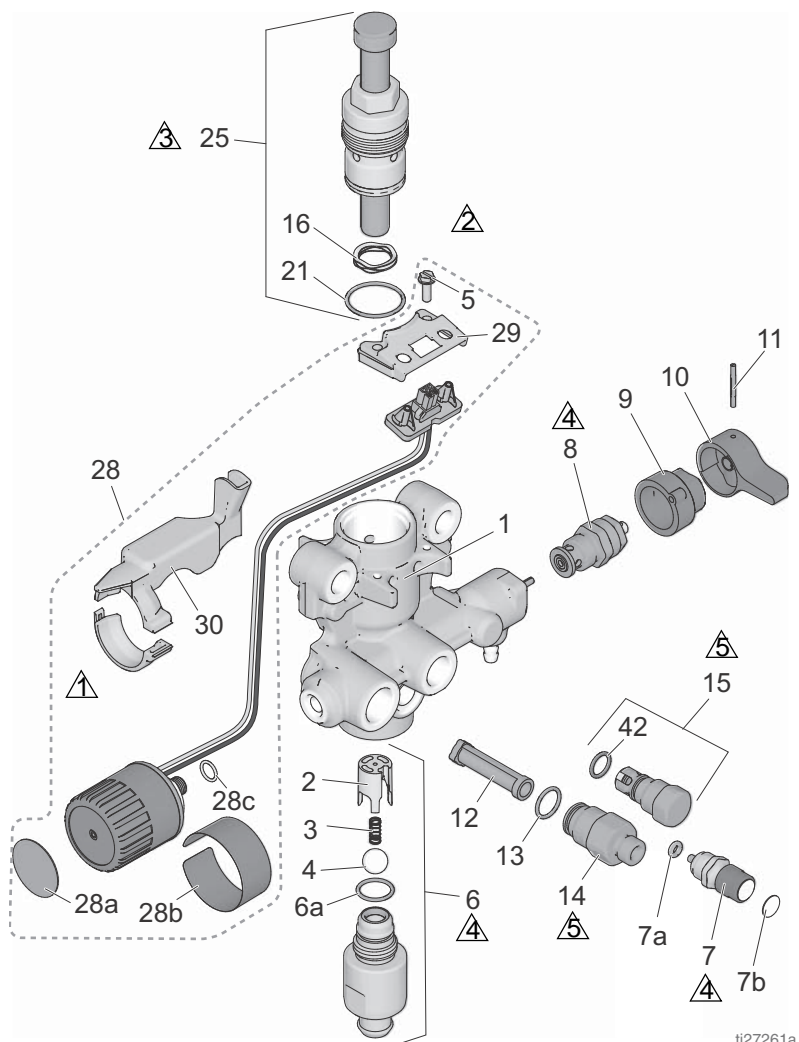

ti27261a

ProXChange Pump (ProX only)

Pump Parts List

Ref.	Part	Description	Qty.	Ref.	Part	Description	Qty.
1	17G447	HOUSING, pump	1	13	120776	PACKING, O-ring	1
2	17D364	GUIDE, ball	1	14	24Y327	KIT, repair outlet <i>includes 12.13</i>	1
3	128336	SPRING, compression	1	15	17J880	KIT, outlet valve repair <i>includes 42</i>	1
4	105445	BALL, 0.5 in.	1	16	128323	SPRING, valve	1
5	117501	SCREW, mach, slot HWH	2	21	16D531	PACKING, O-ring	1
6		KIT, inlet housing		25	24Y472	KIT, repair, piston pump	1
	17J876	ProX17, ProX19	1	28	17J881	KIT, pressure control <i>includes 5, 28a, 28b, 28c, 29, 30</i>	1
	17J877	ProX21	1	28a	15A464	LABEL, control	1
6a	124582	O-ring	1	28b	15K530	LABEL, control	1
7	17J878	KIT, PushPrime <i>includes 7a, 7b</i>	1	28C	106555	O-ring	1
7a	16P303	PACKING, O-ring	1	29	17F227	BRACKET, electrical connector	1
7b	17G540	LABEL, PushPrime	1	30	17F229	KIT, shield, wire	1
8	235014	VALVE, drain, assy	1	42	122486	PACKING, O-ring	1
9	224807	BASE, valve	1				
10	187625	HANDLE, valve, drain	1				
11	111600	PIN, grooved	1				
12	288747	KIT, filter	1				

Wiring Diagram - 110/120V

Wiring Diagram - 110/120V

X5/X7:

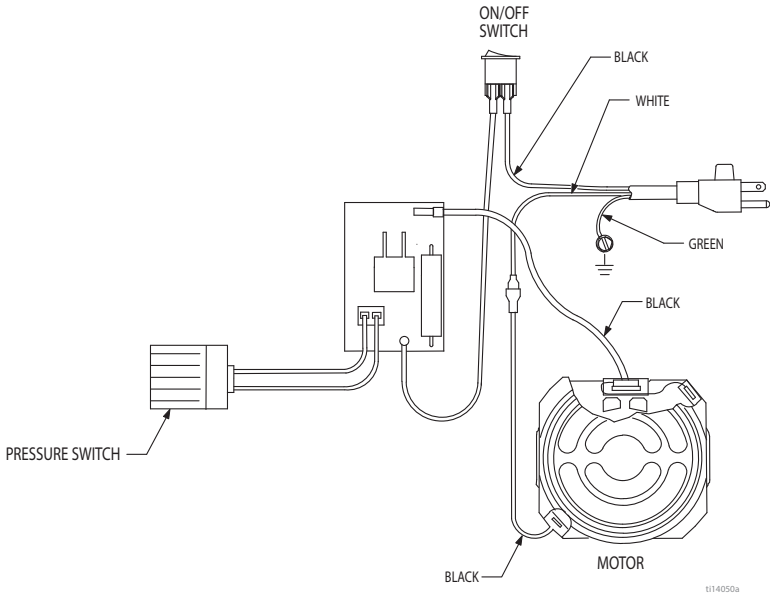

ProX:

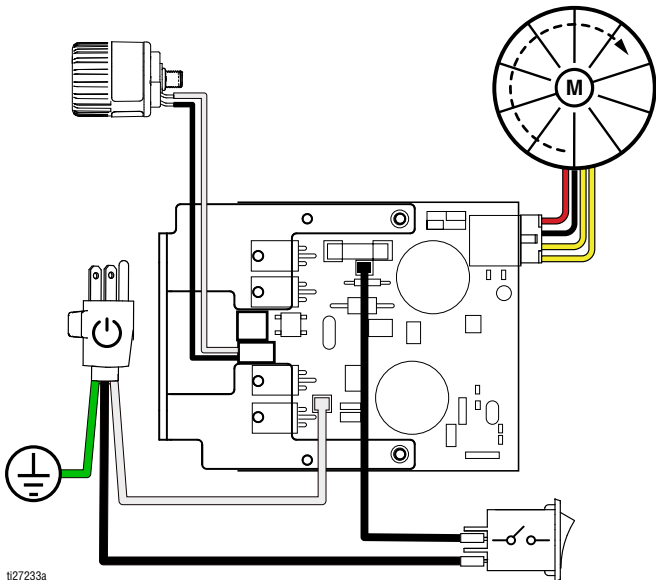

Technical Specifications

	US	Metric
Sprayer		
Maximum fluid working pressure	3000 psi	207 bar, 20.7 MPa
Maximum Delivery		
X5	0.27 gpm	1.0 lpm
X7	0.31 gpm	1.2 lpm
ProX17	0.34 gpm	1.3 lpm
ProX19	0.38 gpm	1.4 lpm
ProX21	0.47 gpm	1.8 lpm
Maximum Tip Size		
X5	0.015 in.	0.38 mm
X7	0.017 in.	0.43 mm
ProX17	0.017 in.	0.43 mm
ProX19	0.019 in.	0.48 mm
ProX21	0.021 in.	0.53 mm
Fluid Outlet npsm	1/4 in.	1/4 in.
Generator Minimum	2500 W	
Power Requirements		
X5, X7	110–120V, 9 A, 1Ø	
ProX17, ProX19	110–120V, 8 A, 1Ø	
ProX21	110–120V, 12 A, 1Ø	
Dimensions		
Height		
X5	17.9 in.	45.5 cm
X7	37.0 in.	94.0 cm
ProX17, ProX19 Stand	21.2 in.	53.9 cm
ProX21 Stand	18.4 in.	46.7 cm
ProX17, ProX19 Cart	37.2 in.	94.5 cm
ProX21 Cart	38.5 in.	97.8 cm
Length		
X5	14.5 in.	36.8 cm
X7	19.3 in.	49.0 cm
ProX17, ProX19 Stand	15.1 in.	38.4 cm
ProX21 Stand	16.7 in.	42.4 cm
ProX17, ProX19 Cart	20.0 in.	50.1 cm
ProX21 Cart	20.8 in.	52.8 cm

Technical Specifications

	US	Metric
Width		
X5	12.4 in.	31.5 cm
X7	15.3 in.	38.9 cm
ProX17, ProX19 Stand	13.2 in.	33.5 cm
ProX21 Stand	13.5 in.	34.3 cm
ProX17, ProX19 Cart	17.2 in.	43.7 cm
ProX21 Cart	20.6 in.	52.3 cm
Weight		
X5	16.5 lb.	7.5 kg
X7	26.5 lb.	12.0 kg
ProX17, ProX19 Stand	27.3 lb.	12.4 kg
ProX21 Stand	25.0 lb.	11.3 kg
ProX17, ProX19 Cart	37.5 lb.	17.0 kg
ProX21 Cart	49.5 lb.	22.5 kg
Storage temperature range ♦❖	-30° to 160°F	-35° to 71°C
Operating temperature range ✓	40° to 115°F	4° to 46°C
Materials of Construction		
Wetted materials on all models	stainless steel, brass, leather, ultra-high molecular weight polyethylene (UHMWPE), carbide, nylon, aluminum, PVC, polypropylene, fluoroelastomer, plated steel	
Notes		
* Startup pressures and displacement per cycle may vary based on suction condition, discharge head, air pressure, and fluid type.		

- ♦ **When pump is stored with non-freezing fluid. Pump damage will occur if water or latex paint freezes in pump.**
- ❖ Damage to plastic parts may result if impact occurs in low temperature conditions.
- ✓ Changes in paint viscosity at very low or very high temperatures can affect sprayer performance.

Notes

Notes

Graco Standard Warranty

Graco warrants all equipment referenced in this document which is manufactured by Graco and bearing its name to be free from defects in material and workmanship on the date of sale to the original purchaser for use. With the exception of any special, extended, or limited warranty published by Graco, Graco will, for a period of twelve months from the date of sale, repair or replace any part of the equipment determined by Graco to be defective. This warranty applies only when the equipment is installed, operated and maintained in accordance with Graco's written recommendations.

This warranty does not cover, and Graco shall not be liable for general wear and tear, or any malfunction, damage or wear caused by faulty installation, misapplication, abrasion, corrosion, inadequate or improper maintenance, negligence, accident, tampering, or substitution of non-Graco component parts. Nor shall Graco be liable for malfunction, damage or wear caused by the incompatibility of Graco equipment with structures, accessories, equipment or materials not supplied by Graco, or the improper design, manufacture, installation, operation or maintenance of structures, accessories, equipment or materials not supplied by Graco.

This warranty is conditioned upon the prepaid return of the equipment claimed to be defective to an authorized Graco distributor for verification of the claimed defect. If the claimed defect is verified, Graco will repair or replace free of charge any defective parts. The equipment will be returned to the original purchaser transportation prepaid. If inspection of the equipment does not disclose any defect in material or workmanship, repairs will be made at a reasonable charge, which charges may include the costs of parts, labor, and transportation.

THIS WARRANTY IS EXCLUSIVE, AND IS IN LIEU OF ANY OTHER WARRANTIES, EXPRESS OR IMPLIED, INCLUDING BUT NOT LIMITED TO WARRANTY OF MERCHANTABILITY OR WARRANTY OF FITNESS FOR A PARTICULAR PURPOSE.

Graco's sole obligation and buyer's sole remedy for any breach of warranty shall be as set forth above. The buyer agrees that no other remedy (including, but not limited to, incidental or consequential damages for lost profits, lost sales, injury to person or property, or any other incidental or consequential loss) shall be available. Any action for breach of warranty must be brought within two (2) years of the date of sale.

GRACO MAKES NO WARRANTY, AND DISCLAIMS ALL IMPLIED WARRANTIES OF MERCHANTABILITY AND FITNESS FOR A PARTICULAR PURPOSE, IN CONNECTION WITH ACCESSORIES, EQUIPMENT, MATERIALS OR COMPONENTS SOLD BUT NOT MANUFACTURED BY GRACO. These items sold, but not manufactured by Graco (such as electric motors, switches, hose, etc.), are subject to the warranty, if any, of their manufacturer. Graco will provide purchaser with reasonable assistance in making any claim for breach of these warranties.

In no event will Graco be liable for indirect, incidental, special or consequential damages resulting from Graco supplying equipment hereunder, or the furnishing, performance, or use of any products or other goods sold hereto, whether due to a breach of contract, breach of warranty, the negligence of Graco, or otherwise.

FOR GRACO CANADA CUSTOMERS

The Parties acknowledge that they have required that the present document, as well as all documents, notices and legal proceedings entered into, given or instituted pursuant hereto or relating directly or indirectly hereto, be drawn up in English. Les parties reconnaissent avoir convenu que la rédaction du présente document sera en Anglais, ainsi que tous documents, avis et procédures judiciaires exécutés, donnés ou intentés, à la suite de ou en rapport, directement ou indirectement, avec les procédures concernées.

Graco Information

For the latest information about Graco products, visit www.graco.com.

For patent information, see www.graco.com/patents.

TO PLACE AN ORDER, contact your Graco distributor or call 1-800-690-2894 to identify the nearest distributor.

10277586A



Every Graco purchase comes with A+ Customer Service.

Call: (888) 541-9788 or go to magnum.graco.com for videos and product information.

PROVEN QUALITY. LEADING TECHNOLOGY.

All written and visual data contained in this document reflects the latest product information available at the time of publication.

Graco reserves the right to make changes at any time without notice.

Original instructions. This manual contains English. MM 3A3208

Graco Headquarters: Minneapolis

International Offices: Belgium, China, Japan, Korea

GRACO INC. AND SUBSIDIARIES • P.O. BOX 1441 • MINNEAPOLIS MN 55440-1441 • USA

Copyright 2015, Graco Inc. All Graco manufacturing locations are registered to ISO 9001.

www.graco.com

Revision B, February 2016