

Assembly Instructions

Hammock on Wooden Stand

Caution: You must read this before you proceed

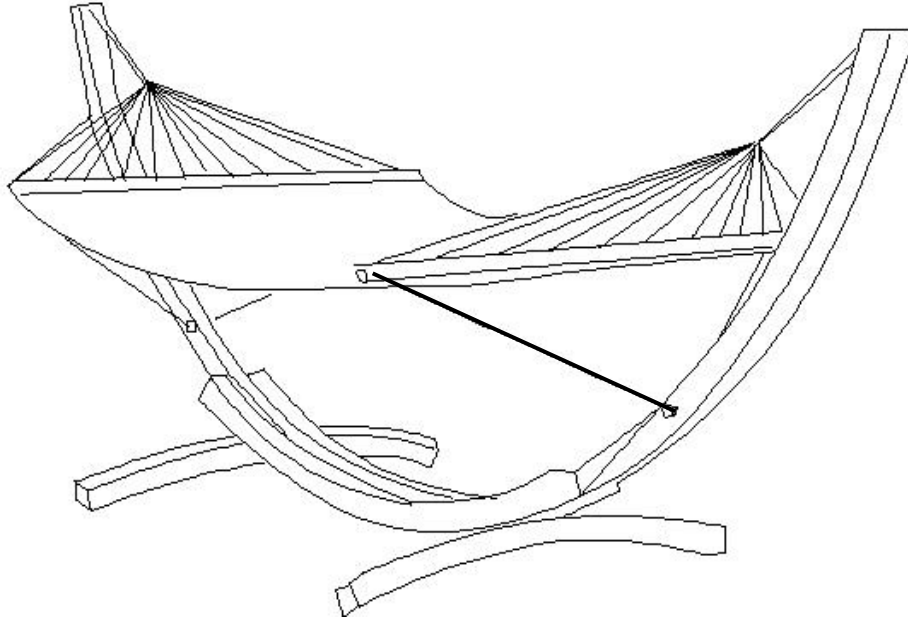





CAUTION : Do Not Swing on or in Hammock. This could cause the product to tip over resulting in possible injury.

This Hammock on Wooden Stand is NOT a TOY.



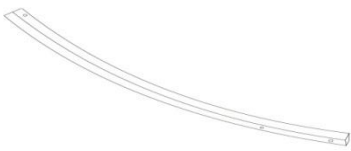



Keep your child / children at bay in the process of assembly.

Have at least three adults to assist when assembling this Hammock on Wooden Stand.

Parts List

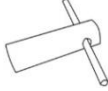
Label	Picture	Description	QTY
A		Supporting Bar	2
B		Mid-Joint Support Bar	2
C		Ground Bar	2
M		Hammock	1
O		Rope with Carabiners	4

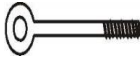
Hardware

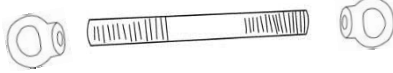
Label	Picture	Description	QTY
D		Bolt (M10*13CM)	4
E		Washer	19
F		Nut	10
L		Bucket Wrench	2
H		Bolt (M10X23CM)	4
J		Metal Chain with Iron Carabiners	2
K		Eye Bolt (M10*60MM)	2
Q		Bolt and Ring Nut (M8*15MM)	4
R		Allen Key	1
N		Bolt and Ring Nut (M8*11CM)	2

Assembly Preparation

Before Beginning Assembly:

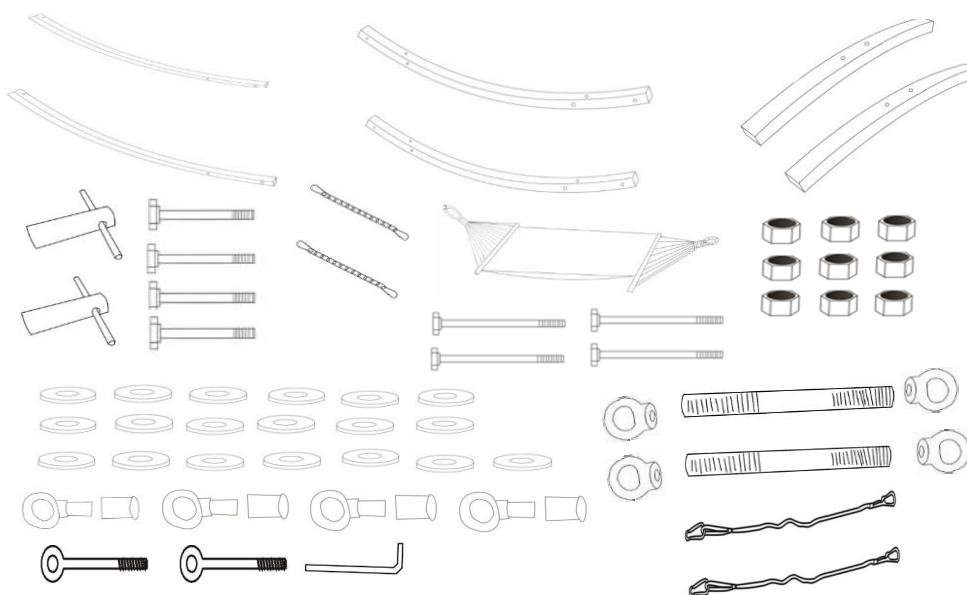

- Read instructions, cover to cover-



- Have 2 adults on hand for assembly-



- Do not assemble on flooring or carpet-



- Assemble on a clean non-marring surface (packing foam)-



- Save all packaging until finished-

Assembly Steps

Overview

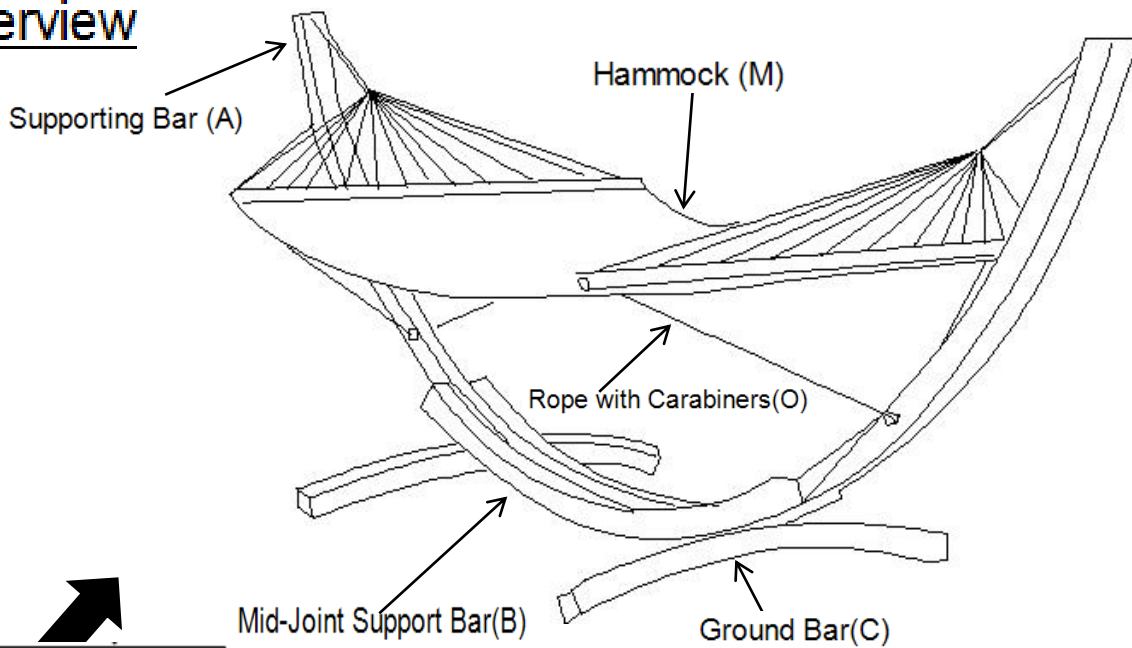

FRONT FACING

This Hammock has multiple parts and may require up to 60 minutes to assemble. To give you an overview of the Hammock parts, the above picture is to help you put the various parts into perspective. Please read through the instructions below to familiarise yourself with the parts and steps before assembly.

NOTE: It is recommended that you have a partner to assist during the entire assembly process.

Step 1

Note : The **COUNTERSINK** hole side of Wooden Bar(B) should be on the **outside**.

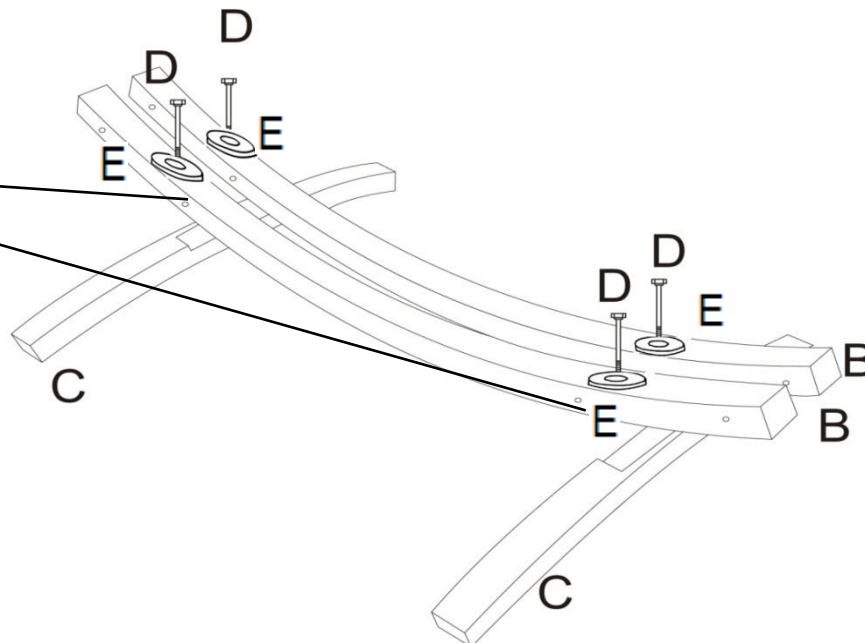

Attach Mid-Joint Support Bar(B) to Ground Bar(C) using Bolt(D) and Washer(E), as shown in the picture.

In this step, **Do not fully tighten the Bolts.**

Step 2

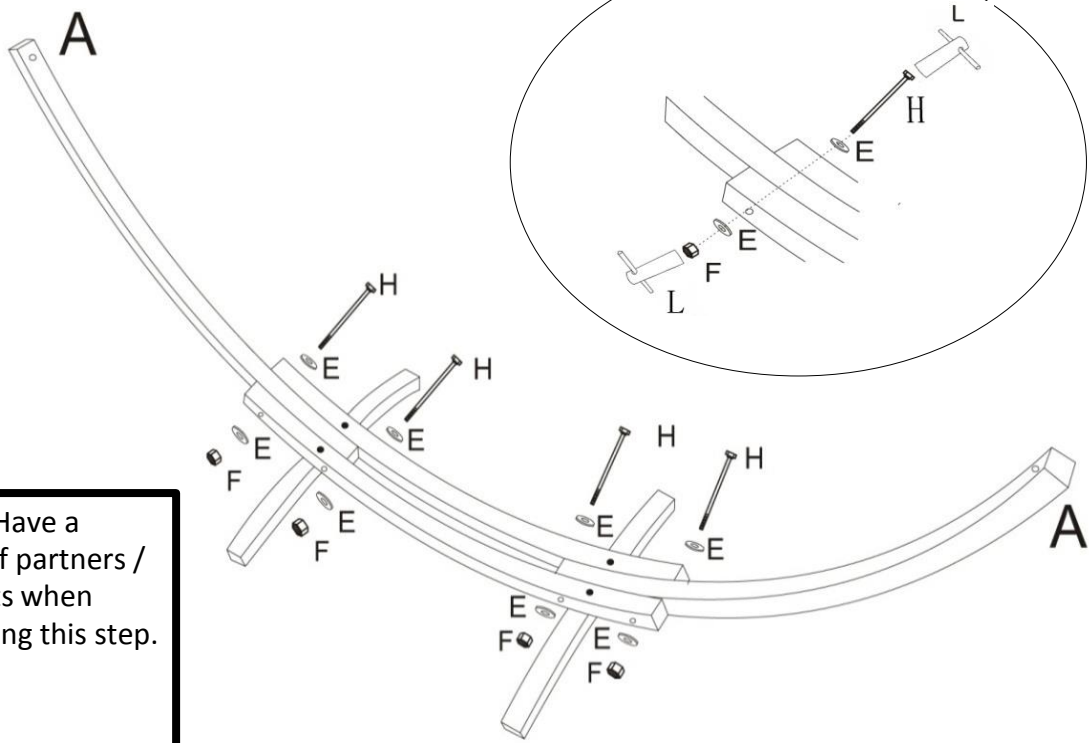

NOTE : Have a couple of partners / assistants when assembling this step.

Put Supporting Bars(A) between Mid-Joint Supporting Bars(B).
Then attach using Bolts(H), Washers(E) and Nuts(F) with Bucket Wrenches(L).
Tighten the Bolts in a sequential manner until fully secure.

Step 3

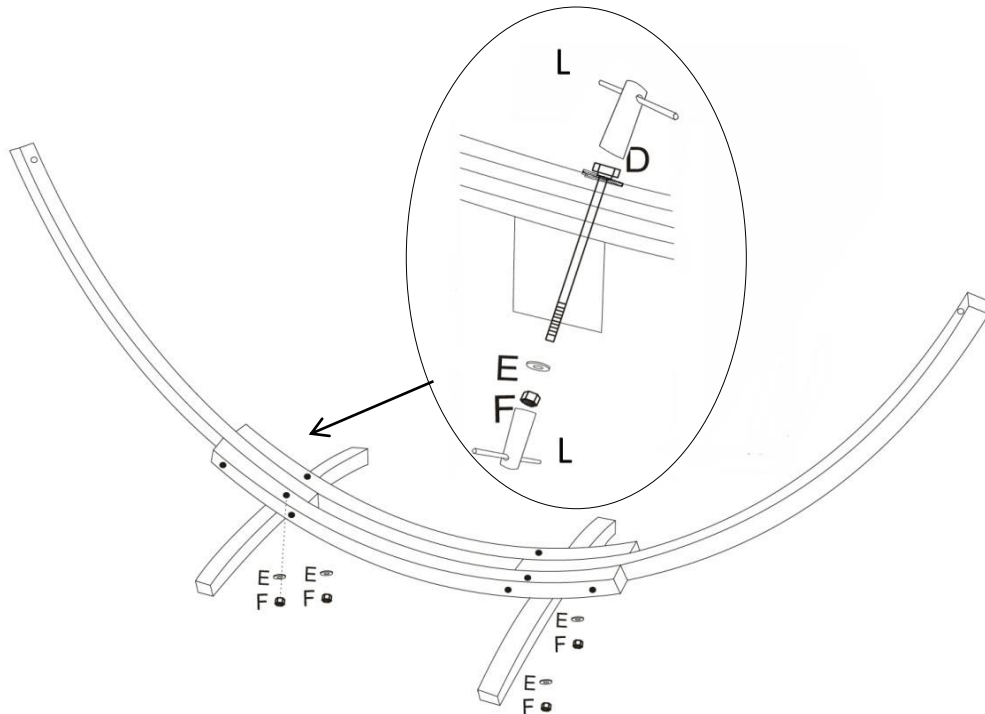

NOTE : This step should be completed with two or more people.

Complete the assembly of Mid-Joint Support Bar(B) to Ground Bar(C) from **Step 1** using Washers(E), and Nuts with Bucket Wrenches(L).
Tighten the Bolts in a sequential manner until fully secure.

Step 4

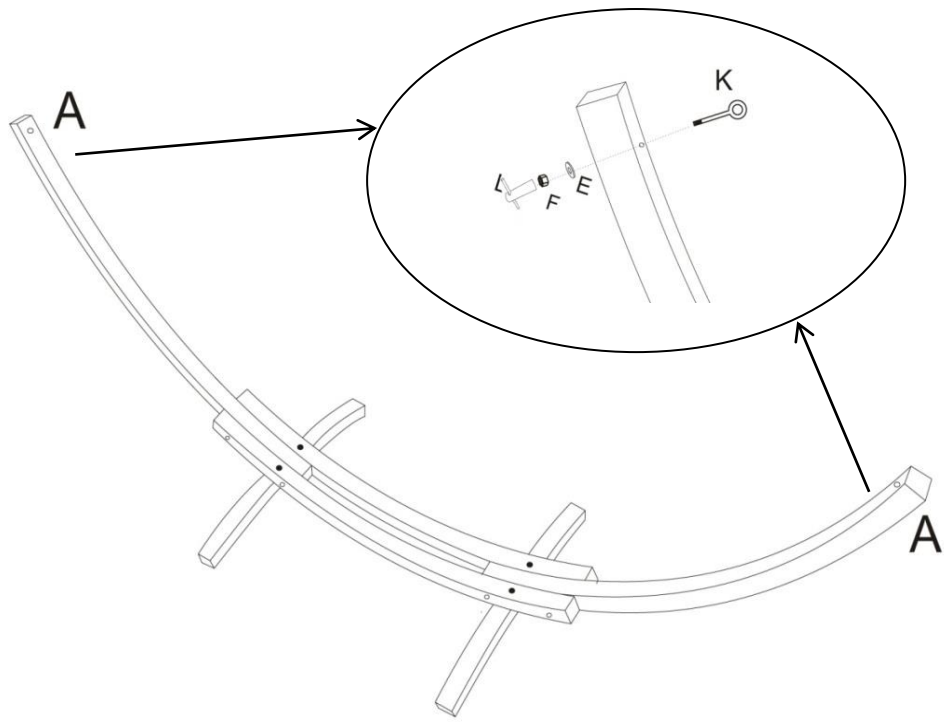

Attach the Eye Bolts(K) to the **tail end** of the Supporting Bars(A) using Washers(E) and Nuts(F) with Bucket Wrench(L).

Tighten the Bolts in a sequential manner until fully secure.

Note: The Eye Bolts should be facing the inside of the frame assembly, as pictured.

Step 5

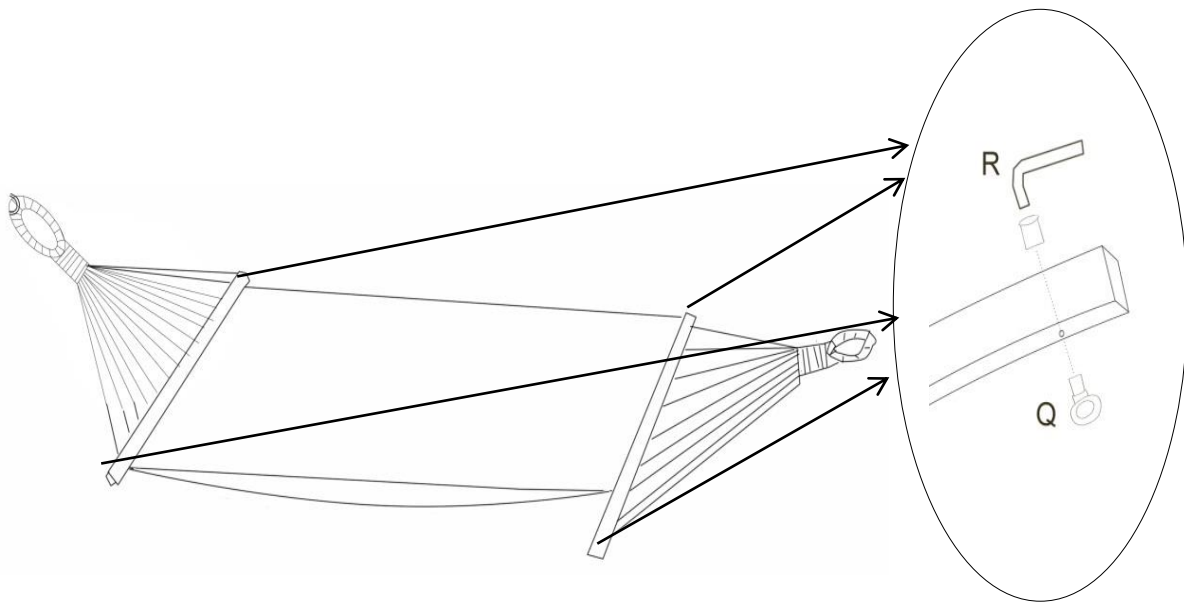

Screw the Bolt and Ring Nuts(Q) to the four ends of the Wooden Support Rails with Allen Key(R)

Tighten the Bolts in a sequential manner until fully secure.

Step 6

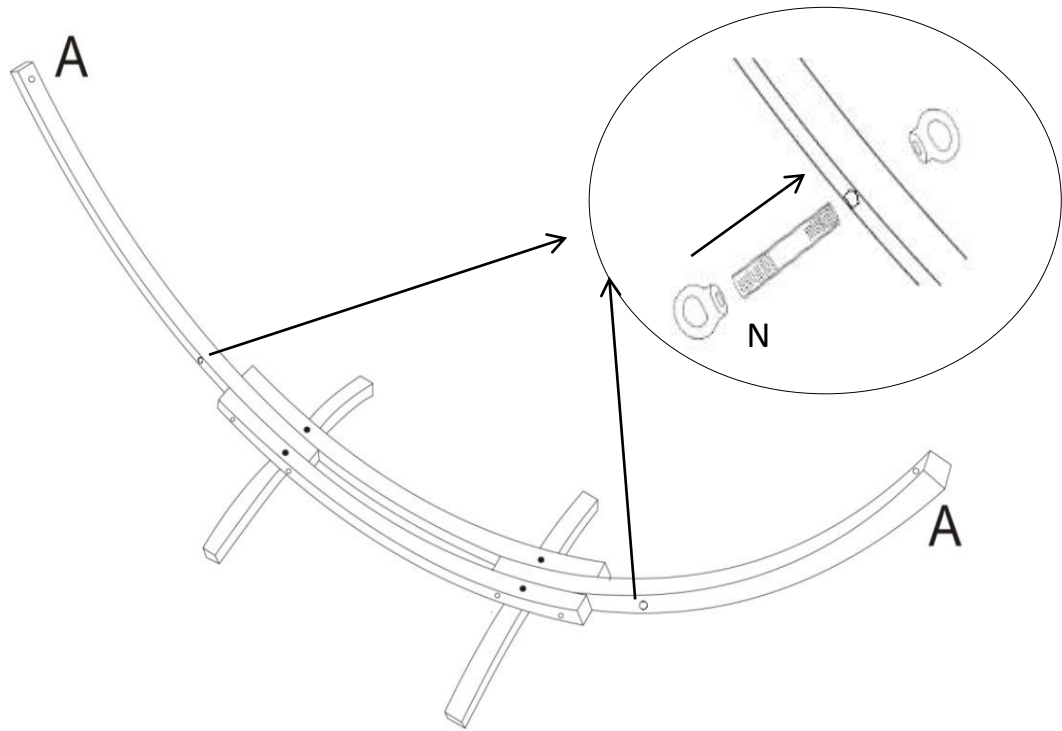

Insert the Bolt and Ring Nuts(N) into the Supporting Bars(A), as shown in the picture.
Tighten the Bolts of this step completely by hand.

Step 7

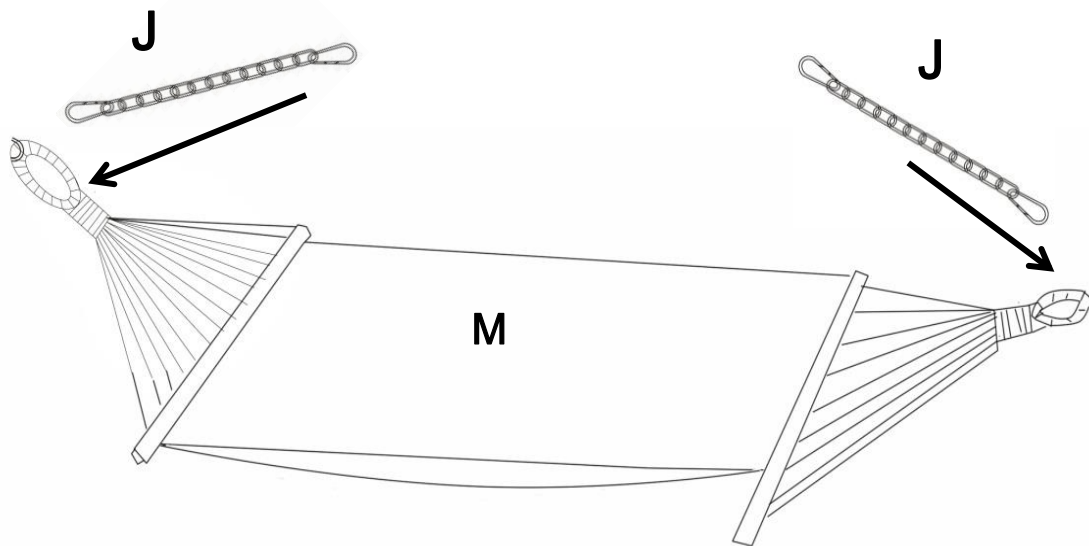

Hook the Chain with Carabiners(J) to the Loops at the ends of the Hammock(M).

Step 8

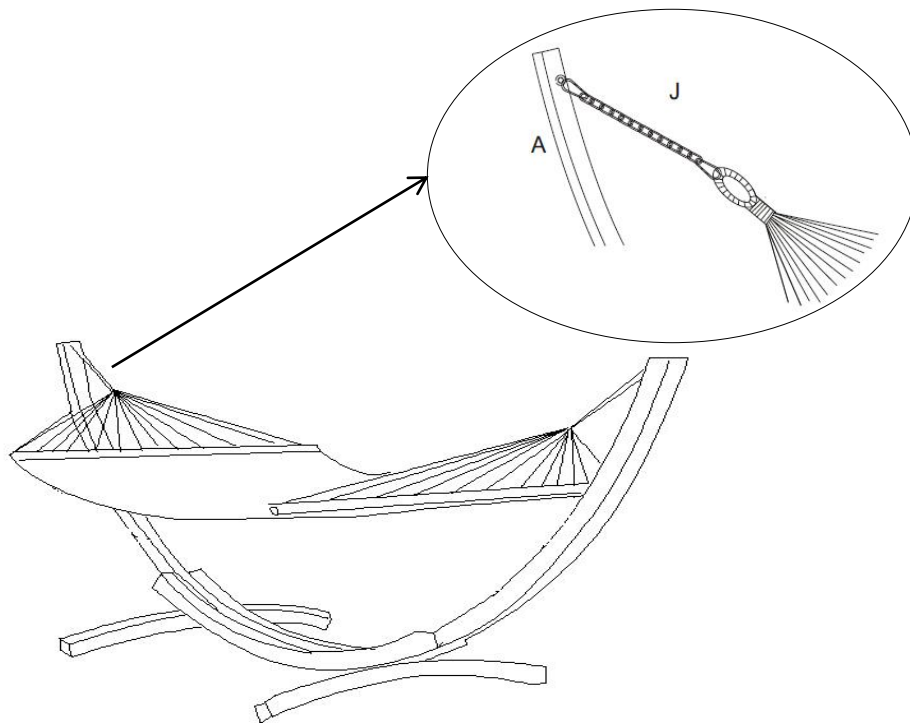

Connect the Hammock(M) to the Supporting Bars(A) using the Chain with Carabiners(J).

Step 9

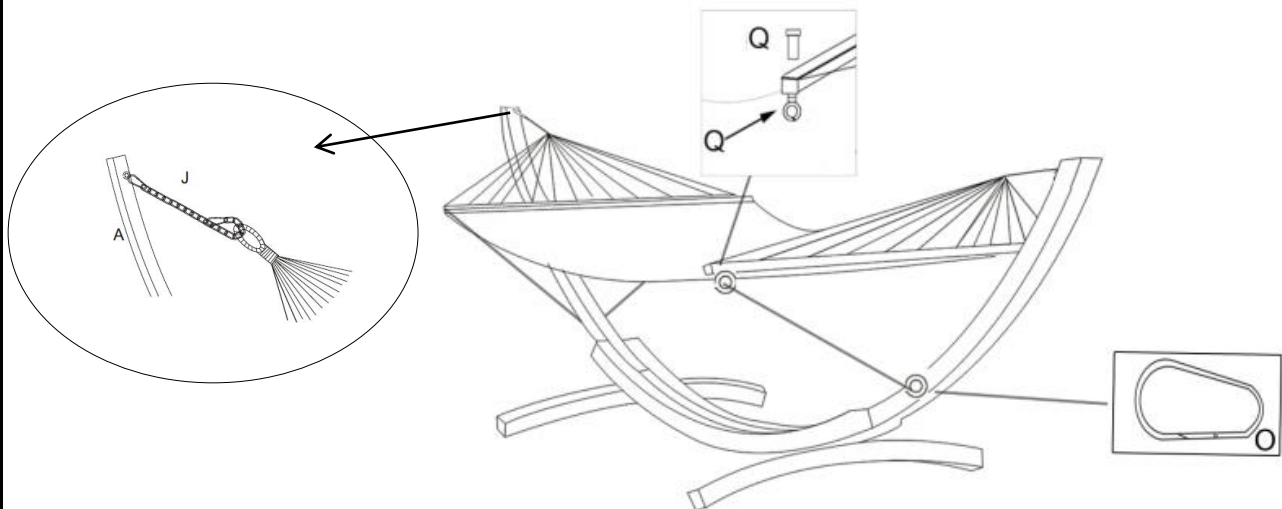

Connect the four Eye Bolts(K) on the Hammock(M) to the Bolt and Ring Nut(N) on Supporting Bars(A) with Rope with Carabiners(O).

















Adjust the Chain with Carabiners(J) until the four Ropes are taut.

Your Hammock on Wooden Stand is ready for use.

Always be careful of your safety when getting on and off of the Hammock; children should not be allowed on the Hammock without adult supervision.

This Hammock on Wooden Stand can only be used on a flat, level surface.

Care & Maintenance

-   ● Do not put hot items directly on furniture surface.
 -   ● Do not clean furniture with harsh cleansers or polish.
 -   ● To obtain the longest lifespan of your outdoor products, minimizing exposure to direct sunlight is recommended.
 -   ● Children should not climb or jump on the furniture.
 -   ● Do not write on furniture without a padded barrier to protect the surface.
 -   ● To obtain the longest lifespan of your outdoor products, avoid extended and lengthy exposure to rain, snow, and direct sunshine. Whenever possible cover the product and /or place under patio or awnings.
 -   ● Not for commercial use. For residential use only.
 -   ● Stains may be removed with mild soap solution and damp cloth.
-
-   ● Dust and pick-up spills using a clean, non-colored, lint-free cloth.

Questions & Answers about Proposition 65

• What is Proposition 65?

Proposition 65 requires businesses to provide warnings to Californians about significant exposures to chemicals that cause cancer, birth defects or other reproductive harm. These chemicals can be in the products that Californians purchase, in their homes or workplaces, or that are released into the environment. By requiring that this information be provided, Proposition 65 enables Californians to make informed decisions about their exposures to these chemicals.

Proposition 65 also prohibits California businesses from knowingly discharging significant amounts of listed chemicals into sources of drinking water.

Proposition 65 requires California to publish a list of chemicals known to cause cancer, birth defects or other reproductive harm. This list, which must be updated at least once a year, has grown to include approximately 900 chemicals since it was first published in 1987.

• What types of chemicals are on the Proposition 65 list?

The list contains a wide range of naturally occurring and synthetic chemicals that include additives or ingredients in pesticides, common household products, food, drugs, dyes, or solvents. Listed chemicals may also be used in manufacturing and construction, or they may be byproducts of chemical processes, such as motor vehicle exhaust.

• What does a warning mean?

If a warning is placed on a product label or posted or distributed at a workplace, a business, or in rental housing, the business issuing the warning is aware or believes that it is exposing individuals to one or more listed chemicals.

By law, a warning must be given for listed chemicals unless the exposure is low enough to pose no significant risk of cancer or is significantly below levels observed to cause birth defects or other reproductive harm.

• Where can I get more information on Proposition 65?

If you have specific questions on the administration or implementation of Proposition 65, you can contact OEHA's Proposition 65 program at P65.Questions@oehha.ca.gov, or by phone at (916) 445-6900.