

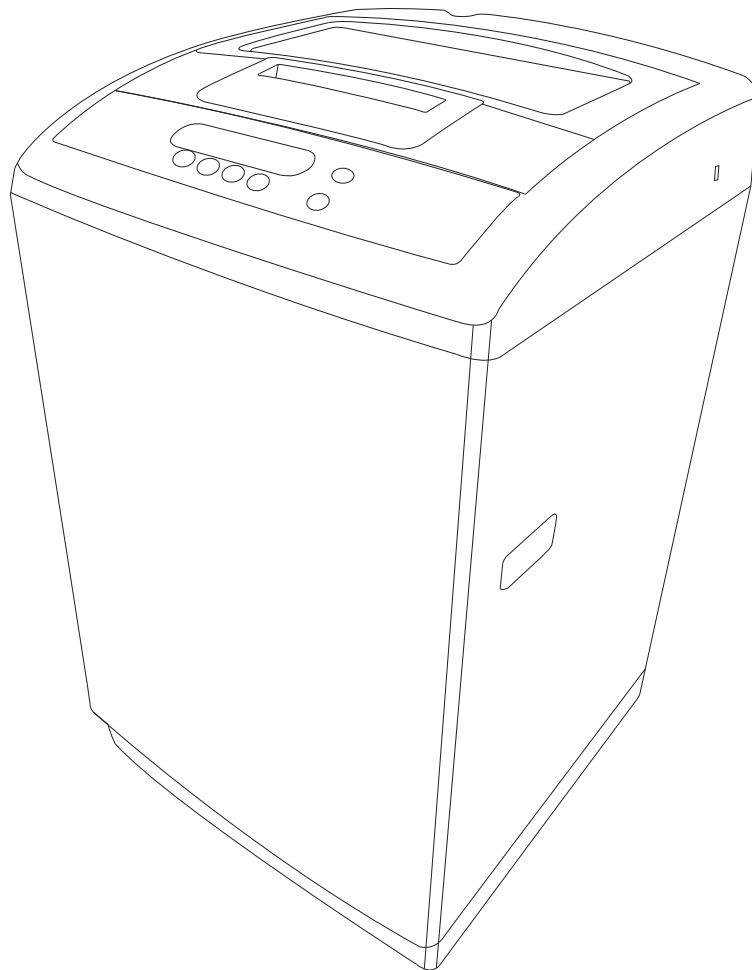

1.6 CU. FT. WASHING MACHINE
Lavadora portátil de 1.6 pies cúbicos



USER MANUAL
MODEL PAN50SW

Contents

Contents	
Safety And Precautions	2
Basic Precautions	3
Installation Warnings And Precautions	4
Usage And Maintenance Warnings And Precautions	5
Installation Instructions.....	9
Unpacking and Removing Shipping Material.....	9
Key Parts and Components.....	10
Accessories.....	10
Tools Needed in Installation	10
Key Dimensions and Specifications	11
Choose the Proper Location.....	11
Install Your Washer.....	12
How To Use	17
Control Panel	17
Washing a Load of Laundry	18
Cycle Guide	20
Care And Cleaning	22
Regular Cleaning and Maintenance.....	22
Troubleshooting	27
Before Calling for Service	27
Error Codes	27
Appendix	28
Warranty.....	29
Service.....	30









Safety and Precautions

This manual contains important information on the installation, use, and care of your appliance. Please read this manual carefully before installation and operation of this machine to prevent injury and property damage.

WHAT YOU NEED TO KNOW ABOUT SAFETY INSTRUCTIONS

Warnings and Important Safety Instructions in this manual DO NOT cover all possible conditions and situations that may occur. It is your responsibility to use common sense, caution and care when installing, maintaining and operating your washer.

IMPORTANT SAFETY SYMBOLS AND PRECAUTIONS

	WARNING	This indicates that hazards or unsafe practices may cause serious personal injury or death . To reduce the risk of fire, explosion, electric shock, or personal injury when using your washer, these basic safety precautions SHOULD be followed.
	CAUTION	This indicates that hazards or unsafe practices may cause minor personal injury or property damage .
		This graphic represents CAUSE ATTENTION, and detailed cautions will be displayed in side the graphic  .
		This graphic represents OPERATION PROHIBITED, and detailed prohibitive items will be displayed in side the graphic  .
		This graphic represents FORBIDDEN EXECUTION, and detailed forbidden execution items will be displayed inside the graphic  .

State of California Proposition 65 Warnings

 **WARNING** The California Safe Drinking Water and Toxic Enforcement Act requires the Governor of California to publish a list of substances known to the State of California to cause cancer, birth defects, or other reproductive harm, and requires business to warn of potential exposure to such substances. This product contains a chemical known to the State of California to cause cancer, birth defects, or other reproductive harm. This appliance can cause low-level exposure to some of the substances listed, including benzene, formaldehyde, and carbon monoxide.

Safety and Precautions

Basic Precautions



WARNING

1. Read all instructions before using the appliance.
2. Use this appliance only for its intended purpose as described in this owner's Manual.
3. Before use, the washer must be properly installed as described in this manual.
4. ALWAYS follow the fabric care instructions supplied by the garment manufacturer.
5. Do not wash or dry articles that have been previously cleaned in, washed in, soaked in, or spotted with gasoline, dry-cleaning solvents, other flammable or explosive substances as they give off vapors that could ignite or explode.
6. Do not allow children to play on or in the appliance. Close supervision of children is necessary when the appliance is used near children.
7. Before the appliance is removed from service or discarded, remove the lid of the washing or drying compartment.
8. Do not reach into the appliance if the basket is moving.
9. Do not install or store this appliance where it will be exposed to the weather or freezing temperatures.
10. Do not tamper with the controls.
11. Do not repair or replace any part of the appliance or attempt any servicing unless it is specifically recommended in the user-maintenance instructions or in published user-repair instructions that you understand and have the skills to carry out.
12. Do not add gasoline, dry-cleaning solvents, or other flammable or explosive substances to the wash water. These substances give off vapors that could ignite or explode.
13. Under certain conditions, hydrogen gas may be produced in a hot water system that has not been used for 2 weeks or more.
14. HYDROGEN GAS IS EXPLOSIVE. If the hot water system has not been used for 2 weeks or more, before using a washer or combination washer-dryer, turn on all hot water faucets and let the water flow from each for several minutes. This will release any accumulated hydrogen gas. As the gas is flammable, do not smoke or use an open flame during this time.
15. Keep the area underneath and around your appliances free of combustible materials (lint, paper, rags, etc.), gasoline, chemicals and other flammable vapors and liquids.
16. Do not place items exposed to cooking oil in your washer. Items contaminated with cooking oils may contribute to a chemical reaction that could cause a load to catch fire.
17. This washer is not designed for maritime use or for mobile installations such as in RVs, aircraft, etc.
18. Turn off the water faucets and unplug the washer if the machine is to be left for an extended period of time, such as during vacations.
19. Packaging material can be dangerous for children. There is a risk of suffocation! Keep all package away from children.
20. Always check the inside of the washer for foreign objects before loading laundry. Keep the lid closed when not in use.

Safety and Precautions

Installation Warnings and Precautions



WARNING



Power Cord and Socket



Earthing



Location

1. Plug the power cord into an AC 120V/60Hz wall socket rated at 15amps or higher. Use the socket for this washer only.
2. Do not use an extension cord.
 - Sharing a wall socket with other appliance, using a power strip, or extending the power cord may result in electric shock or fire.
 - Do not use an electric transformer. It may result in electric shock or fire.
 - Ensure that the power voltage, frequency, and current match the product's specifications. Failing to do so may result in electric shock or fire.
3. Have this appliance installed by a qualified technician or service company.
 - Failing to do so may result in electric shock, fire, explosion, problems with the product, or injury.
4. Remove all foreign substances such as dust or water from the power plug terminals and contact points using a dry cloth on a regular basis.
 - Unplug the power plug and clean it with a dry cloth.
 - Failing to do so may result in electric shock or fire.
5. Plug the power plug into the wall socket in the right direction so that the cord runs towards the floor.
 - If you plug the power plug into the socket in the opposite direction, the electric wires within the cable may be damaged and this may result in electric shock or fire.
6. Plug the power plug into the wall socket firmly. Do not use a damaged power plug, or loosen wall socket.
 - This may result in electric shock or fire.
7. Do not pull or excessively bend the power cord.
8. Do not twist or tie the power cord.
9. Do not hook the power cord over a metal object, place a heavy object on the power cord, insert the power cord between objects, or push the power cord into the space behind the appliance.
 - This may result in electric shock or fire.
10. Do not pull the power cord when unplugging the power plug.
 - Unplug the power plug by holding the plug.
 - Failing to do so may result in electric shock or fire.
11. If the power plug or power cord are damaged, contact your nearest service center.
 1. This appliance must be properly grounded.
 2. Do not ground the appliance to a gas pipe, plastic water pipe, or telephone line.
 - Improper grounding may result in electric shock, fire, explosion, or problems with the product.
 - Never plug the power cord into a socket that is not grounded correctly. Make sure the socket you use is grounded in accordance with local and national codes.
1. Do not install this appliance near a heater or inflammable material.
2. Do not install this appliance in a humid, oily, or dusty location, or in a location exposed to direct sunlight or water (rain drops).
3. Do not install this appliance in a location where gas may leak.
 - This may result in electric shock or fire.
4. If the washer is moved to a new location, have it checked and re-installed by a qualified service technician.
 - Failing to follow this warning may result in electric shock or fire.

Safety and Precautions

Installation Warnings and Precautions



CAUTION

1. Do not install on carpet. Install washer on a level and solid floor that can support its weight.
 - Failing to do so may result in abnormal vibrations, noise, or problems with the product.
2. The washer is heavy. Two or more people may be needed to install and move the appliance.
 - Failing to do so may result in bodily or other injuries.
3. Store and install the washer where it will not be exposed to temperatures below freezing or exposed to outdoor weather conditions.
 - Failing to do so may result in serious leak damage.
4. Position the appliance so that the power plug is easily accessible.
 - Failing to do so may result in electric shock or fire due to electric leakage.
5. To reduce the risk of injury to persons, adhere to all industry recommended safety glasses.
 - Failing to follow all of the safety warnings in this manual may result in property damage, or injury to persons.

Usage and Maintenance Warnings and Precautions



WARNING

1. If the appliance is flooded, cut the power immediately and contact your nearest service center.
2. If the appliance emits a strange noise, a burning smell, or smoke, unplug the power plug immediately and contact your nearest service center.
 - Failing to do so may result in electric shock or fire.
3. In the event of a gas leak (such as propane gas, LP gas, etc.), ventilate the area immediately. Do not turn any appliance or light on or off.
 - Do not use a ventilating fan.
 - A spark may result in an explosion or fire.
4. Do not wash items contaminated with gasoline, kerosene, benzene, paint thinner, alcohol, dry cleaning detergent or other flammable or explosive substances.
 - This may result in electric shock, fire, or an explosion.
5. Do not force the washer lid open while the washer is operating (high-temperature washing / drying / spinning).
 - Water flowing out of the washer may cause burns or cause the floor to be slippery. This may result in injury.
 - Forcing the lid open can damage the product or cause injury.
6. Make sure to remove the packaging (sponge, styrofoam) attached to the bottom of the washer before using it.
7. Do not insert your hand or a metal object under the washer.
 - This may result in injury.
8. Do not attempt to operate this appliance if it is damaged, malfunctioning, partially disassembled, or has missing or broken parts, including a damaged cord or plug.
 - This may result in electric shock, fire or death.
9. Do not touch the power plug with wet hands.
 - This may result in electric shock.
10. Do not turn the appliance off by unplugging the power plug while the washer is in operation.
 - Plugging the power plug into the wall socket again may cause a spark and result in electric shock or fire.
11. Keep all packaging material well out of the reach of children, as packaging materials can be dangerous to children.
 - If a child places a bag over its head, it may suffocate.

Safety and Precautions

Usage and Maintenance Warnings and Precautions



WARNING

12. Do not let children or infirm persons use this washer unsupervised.
 - Failing to do so may result in electric shock, burns or injury.
13. Do not attempt to repair, disassemble, or modify the appliance yourself.
 - Do not use any fuse (such as cooper, steel wire, etc.) other than the standard fuse.
 - If you need to repair or reinstall the appliance, contact your nearest service center.
 - Failing to do so may result in electric shock, fire, problems with the product, or injury.
14. If any foreign substance such as water enters the appliance in any area other than the tub, unplug the power plug and contact your nearest service center.
 - Failing to do so may result in electric shock or fire.
15. If the water supply hose comes loose from the faucet and floods the appliance, unplug the power plug.
 - Failing to do so may result in electric shock or fire.
16. Do not mix chlorine bleach with ammonia or acids such as vinegar.
 - Incorrect usage can produce poisonous gas, result in serious injury.
17. Do not reach into the washer while parts are moving. Before loading, unloading, or adding items, press the START/PAUSE button and allow the basket to come to complete stop before reaching inside.
 - Failing to do so may result in electric shock, injury or fire.
18. Do not allow children to play on or in the washer. Close supervision of children is necessary when the washer is used near children. As children grow, teach them the proper, safe use of all appliances.
 - Failing to do so may result in serious injury to persons.
19. Keep laundry products out of children's reach. Observe all warnings on product labels and follow to do.
 - Failing to do so may result in serious injury to persons.
20. Disconnect this appliance from the power supply before attempting any user maintenance. Turning the controls to the OFF position does not disconnect this appliance from the power supply.
 - Failing to do so may result in electric shock, injury or fire.
21. Do not clean the appliance by spraying water directly onto it.
22. Do not use benzene, thinner, or alcohol to clean the appliance.
 - This may result in discoloration, deformation, damage, electric shock or fire.

Usage and Maintenance Warnings and Precautions



CAUTION

1. Unplug the power plug when the appliance is not being used for long periods of time or during a thunder/lightning storm.
 - Failing to do so may result in electric shock or fire.
2. Keep hands and foreign objects clear of the lid and latch area when closing the lid.
 - Failing to do so may result in personal injury.
3. If the washer is contaminated by a foreign substance such as detergent, dirt, food waste, etc., unplug the power plug and clean the washer with a damp, soft cloth.
 - Failing to do so may result in discoloration, deformation, damage or rust.
4. The clear portion of the lid can be broken by a strong impact. Take care when using the washer.
 - If the clear portion is cracked or broken, it may result in injury.
5. After a water supply failure or when reconnecting the water supply hose, open the faucet slowly.

Safety and Precautions

Usage and Maintenance Warnings and Precautions



CAUTION

6. Open the faucet slowly after a long period of non-use.
 - The air pressure in the water supply hose or the water pipe may result in damage to a part or in water leakage.
7. If a drain error occurs during an operation, check if there is a draining problem.
 - If the washer is used when it is flooded because of a draining problem, it may result in electric shock or fire due to electric leakage.
8. Do not insert your hand or a metal object under the washer.
 - This may result in injury.
9. Insert the laundry into the washer completely so that laundry does not get caught in the lid.
 - If laundry gets caught in the lid, it may result in damage to the laundry or the washer, or result in water leakage.
10. Ensure that the faucet is turned off when the washer is not being used.
 - Ensure that the water supply hose connectors are properly tightened.
 - Failing to do so may result in property damage or injury.
11. Open the faucet and check if the water supply hose connector is firmly tightened and that there is no water leaking before using the product.
 - If the water supply hose connectors are loose, it may result in water leakage.
12. Do not stand on top of the appliance or place objects (such as laundry, lighted candles, lighted cigarettes, dishes, chemicals, metal objects, etc.) on the appliance.
 - This may result in electric shock, fire, problems with the product, or injury.
13. Do not operate the appliance with wet hands.
 - This may result in electric shock.
14. Do not spray volatile material such as insecticide onto the surface of the appliance.
 - As well as being harmful to humans, it may also result in electric shock, fire, or problems with the product.
15. Do not place an object that generates an electromagnetic field near the washer.
 - This may result in injury due to a malfunction.
16. Since the water drained during a high temperature wash or drying cycle is hot, do not touch the water.
 - This may result in burns or injury.
17. Do not wash, spin, or dry water-proof seats, mats, or clothing.
 - Do not wash thick, hard mats even if the washer mark is on the care label.
This may result in injury or damage to the washer, walls, floor, or clothing due to abnormal vibrations.
18. Do not operate the washer when detergent dispenser is removed.
 - This may result in electric shock or injury due to water leakage.
19. Do not insert your hand into the detergent dispenser after opening it.
 - This may result in injury as your hand may be caught.
20. Do not place any non-laundry objects, such as shoes, food waste, or animals into the washer.
 - This can cause abnormal vibrations that can damage the washer, and, in the case of pets, cause severe injury or death.
21. Do not press the buttons using sharp objects such as pins, knives, fingernails, etc.
 - This may result in electric shock or injury.

Safety and Precautions

Usage and Maintenance Warnings and Precautions



CAUTION

22. Do not wash laundry contaminated by oils, creams, or lotions usually found in skincare shops or massage clinics.
 - This may result in the rubber seal becoming deformed and water leakage.
23. Ensure that the water inlet pipe is connected and the tap is opened before washing clothes.
24. Do not leave metal objects (safety pins, hair pins, etc.) or bleach in the tub for long periods of time.
 - This may cause the tub to rust.
 - If rust appears on the surface of the tub, apply a neutral cleansing agent to the surface and use a sponge to clean it. Never use a metal brush.
25. Do not use hot water from water cooling/heating devices.
 - This may result in problems with the washer.
26. Do not use natural hand-washing soap in the washer.
 - If it hardens and accumulates inside the washer, it may cause problems with the product, discoloration, rust, or bad odors.
27. Do not wash large laundry items such as bedding in the washing net.
 - Failing to do so may result in injury due to abnormal vibrations.
 - Place smaller items, such as lace socks and lingerie in the washing net.
28. Do not use hardened detergent.
 - If it accumulates inside the washer, it may result in water leakage.
29. Do not wash throw rugs or doormats.
 - If you wash throw rugs or doormats, the sand will accumulate inside the washer. It may result in error such as no draining.

Installation Instructions

Unpacking and Removing Shipping Material

Remove the packing box and lift the washer up and away from the foam base cushion. Open the lid of washer to take out all accessories including protection foam.

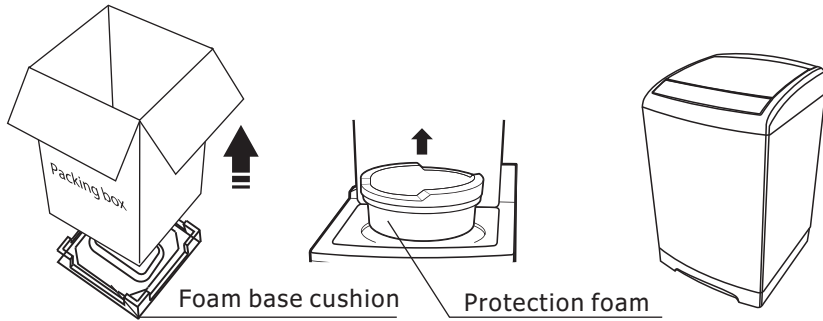

Packaging materials can be dangerous to children; Keep all packaging material (plastic bags, polystyrene, etc.) well out of children's reach. Do not operate this appliance on the foam base cushion. Failing to do so will result in serious vibration.

Key Parts and Components

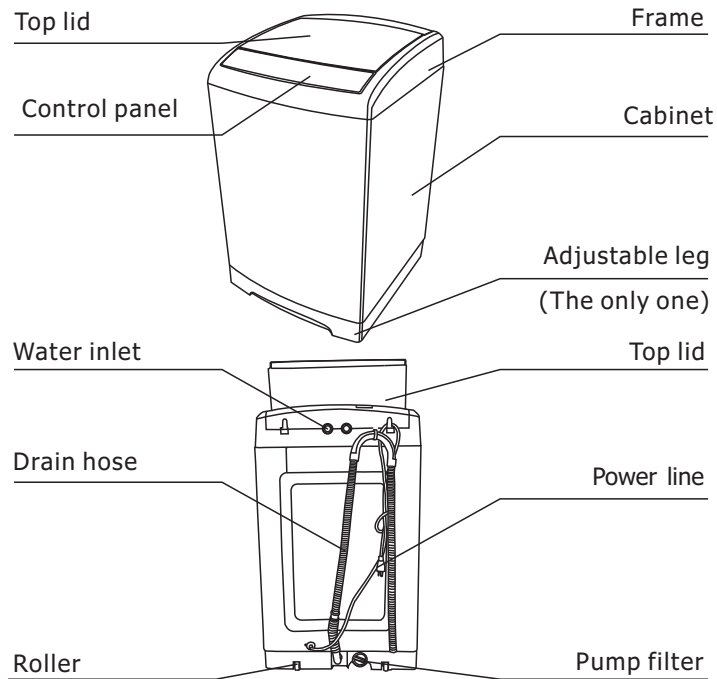

Installation Instructions

Accessories

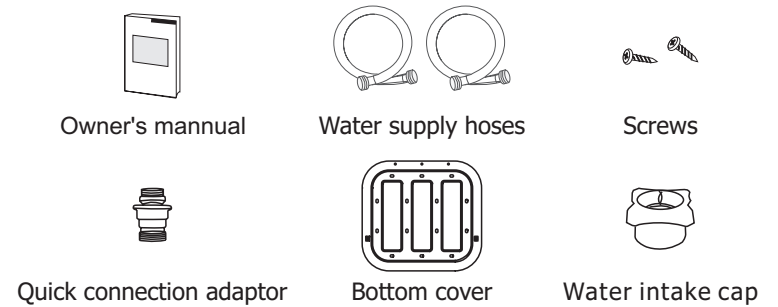

Tools Needed in Installation

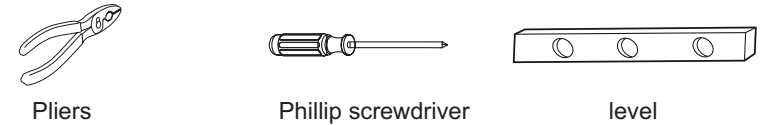

Key Dimensions and Specifications

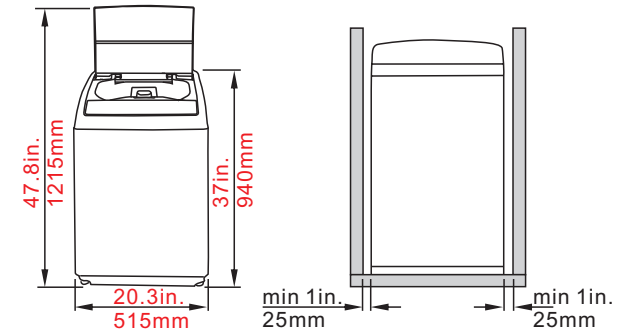

Choose the Proper Location

● Flooring

For best performance, you must install your washer on a solidly constructed floor. Wood floors may need to be reinforced to minimize vibration and/or unbalanced load situations.

- Carpeting and soft tile surfaces are contributing factors to vibration which can cause your washer to move slightly during the spin cycle.



Do not install your washer in areas where water may freeze, since your washer will always retain some water in its water valve, pump, and hose areas. Frozen water can damage the belts, the pump, hoses, and other components. Never install on a platform or weakly supported structure.

Installation Instructions

Choose the Proper Location

• Electric

Use 120Volt 60Hz 15 Amps fuse or circuit breaker.
Individual branch circuit serving only for your washer is recommended.



Never use an extension cord.

• Grounding

Electrical grounding is required for this washer.

This appliance must be grounded. In the event of malfunction or breakdown, grounding will reduce the risk of electric shock by providing a path of least resistance for electric current.

This appliance is equipped with a power cord having a three-prong grounding plug for use in a properly installed and grounded outlet.

The plug must be plugged into an appropriate outlet that is properly installed and grounded in accordance with all local codes and ordinances.



An improperly connected equipment-grounding conductor can increase the risk of electrical shock. Check with a qualified electrician or serviceman if you are not sure whether the appliance is properly grounded. Do not modify the plug provided with the appliance. If it does not fit the outlet, have a proper outlet installed by a qualified electrician. To prevent unnecessary risk of fire, electrical shock or personal injury, all wiring and grounding must be done in accordance with the National Electrical Code ANSI/FNPA, No.70 Latest Revision and local codes and ordinances. It is the personal responsibility of the appliance owner to provide adequate electrical service for this appliance.



Never connect the ground wire to plastic plumbing lines, gas lines, or hot water pipes.

• Water

To correctly fill your washer in the proper amount of time, water pressure of 14 to 70psi (100 to 500 kPa) is required.

Water pressure less than 14psi may cause water valve failure, or may not allow the water valve to shut off completely, or may extend the fill time beyond what your washer controls allow, causing your washer to turn off and alarm error.

A time limit is built into the controls to prevent flooding in your home if a hose becomes loose.

The water faucet must be within 4 feet / 122cm of the back of your washer to match the inlet hoses provided with your washer.

To avoid the possibility of water damage:

- Have water faucets easily accessible
- Turn off faucets when the washer is not in use.
- Periodically check that there is no leakage from the water inlet hose fittings.

Installation Instructions

Choose the Proper Location

• Drain facility

The recommended height of the standpipe is 35in. or 90cm.

The drain hose must be routed through the drain hose clip to the standpipe.

The standpipe must be large enough to accept the outside diameter of the drain hose.

Install Your Washer



Before installing, make sure there are rubber gaskets inside the fittings at both ends of the water supply hoses.

If there are no water inlet hoses packed with the washer or if the hoses are damaged, Call Midea Service Center at 1-866-646-4332. Installing the water supply hoses without rubber gaskets can cause water leakage. When you initially install the washer, be sure to use new hoses. Failing to do so may result in a water leakage or overflow and may damage your property. If a hose is too short, replace the hose with a longer, high pressure hose.

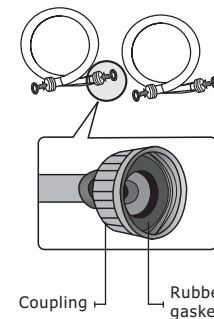

• Step 1: Move your washer to selected position

Tilt the unit back onto its rear rollers and push it forward as shown in the figure below. Move the unit to a location as described in the previous Choose the Proper Location section.

Front of the washer

Back of the washer

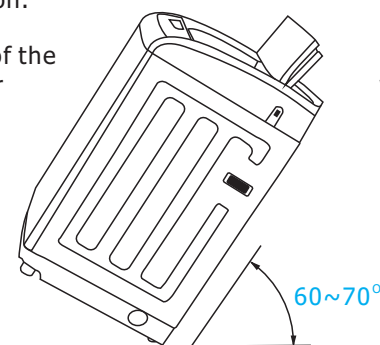

Make sure the location has a hard, level surface without carpeting. There should be no direct sunlight.

Do not expose the unit to freezing temperatures (under 32° F or 0° C).

Installation Instructions

Install Your Washer

● Step 2: Install the Bottom Cover

Slide the bottom cover into the slots on bottom surface of the unit as in the following figure, and fix it with two screws attached with the unit.

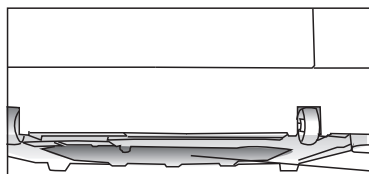

Bottom Cover

● Step 3: Connect the water hose

1. The Quick Connection Adaptor is primarily for quick connection to a single faucet, such as a typical kitchen sink, in cases where the washer is stored in a different place than where it is used. Skip this step if you are connecting the washer to a sink with separate hot and cold faucets.

The adaptor consists of two parts that quickly connect or disconnect. One part, the faucet fitting, is for connection to the faucet and the other part, the hose fitting, connects to the cold water hose of the washer.

- Pull back on the white ring to free the faucet fitting from the adaptor for installation into the faucet.
- Screw the end of the cold water hose onto the base of the hose fitting.
- If the faucet has internal screw threads, unscrew the aerator if present from the tip of the faucet. Then screw the faucet fitting into the faucet. Make sure that the black rubber gasket is on the top of the adaptor before screwing it in.
- If the faucet has external screw threads, remove the gasket from the top of the faucet fitting, and screw the fitting over the external threads.
- Pull back on the white ring to connect the two parts of the adaptor back together.

NOTE:

When connected to a single faucet that can dispense either hot or cold water, both hot and cold water can be run through the cold water line for washing use. However, it is recommended to only run cold water washes when the adaptor is connected to such a faucet.

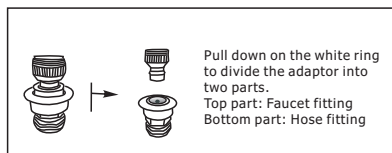

Pull down on the white ring to divide the adaptor into two parts.
Top part: Faucet fitting
Bottom part: Hose fitting

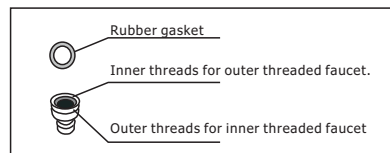

2. Connect the ends of the water supply hoses to the HOT and COLD faucets. For convenience, use the Quick Connection Adaptor for connection to the cold water faucet. See instructions for Quick Connection Adaptor use in Step 1 above.

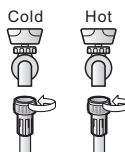

Installation Instructions

Install Your Washer

3. Tighten the fittings by hand until they are snug, and then tighten them an additional two-thirds of a turn with a wrench.



When you fasten the fittings, do not fasten them too tightly or apply tape or sealant to the faucets or water supply intakes. This can damage the fittings. After you have connected the water supply hoses to the faucets, ensure that they are connected securely by pulling the water supply hoses downwards.

4. Place the unconnected ends of the hoses into a bucket and open the faucets connected to the two water supply hoses for 10 or 15 seconds to remove any foreign substances from the hoses. Close the faucets before continuing.



5. Connect the ends of the water supply hoses to the water supply intake connections at the back of the washer.



The water supply hose connected to the HOT faucet must be connected to the hot water supply intake and the water hose connected to the COLD faucet must be connected to the cold water supply intake.

6. Tighten the fittings by hand until they are snug, and then tighten them an additional two-thirds of a turn with a wrench.



Confirm that the water supply hoses are not twisted or bent. If the hoses are twisted or bent, the hoses can leak and cause electric shock due to the water leakage. To ensure the correct water usage, connect both the HOT and COLD water faucets. If either or both are not connected, an error code can occur.

If you do not want to use the HOT water supply hose, install the water intake cap into the HOT water supply intake hole.

In this case, you must select Cold water as the wash temperature choice.

See Wash Temp in Control Panel section on page 19.

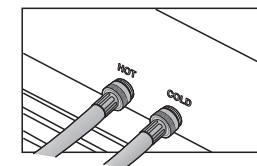

7. Turn on the HOT and COLD water supplies and check all the water supply intake connections and the faucets for water leaks.

Installation Instructions

Install Your Washer

● Step 4: Connect the drain hose

Position the other end of the drain hose. It can be positioned in three ways.

- A. Over the edge of a wash basin.
Secure the guide to the side of the basin wall with a hook or to the tap with a piece of string to prevent the drain hose from moving.
- B. In a standpipe
The standpipe must be no shorter than 32 in. (81cm) and no longer than 39 in. (100cm).
- C. In a laundry tub.
The laundry tub must be no shorter than 32 in. (81cm) and no higher than 39 in. (100cm).

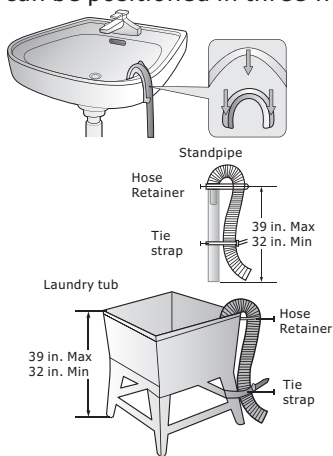

Make sure that the connection between the drain hose and the wash basin, standpipe or laundry tub is not airtight.

● Step 5: Leveling your washer

See if the washer is level by checking the position of the tub or using a leveling gauge.

1. Slide the washer into position.
2. Open the lid of the washer, and pour the water into the tub to just below the pulsator level.
3. If the washer is level, the pulsator is positioned at the center of the washer as shown in the figure above right. If not, level your washer by turning the front leveling feet clockwise or counterclockwise as necessary.

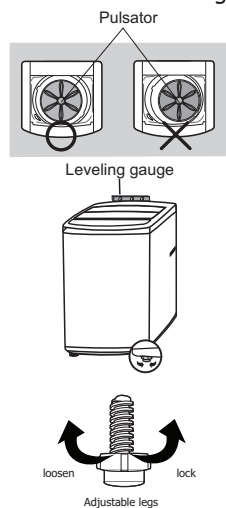

There is **ONLY ONE** adjustable leg as right figure on this washer.

Installation Instructions

Install Your Washer

● Step 6: Powering your washer

Plug the power cord into a 3-prong, well grounded **120Volt 60Hz** approved electrical outlet protected by a 15-amp fuse or comparable circuit breaker.

Your washer is grounded through the third prong of the power cord when plugged into a 3-prong grounded electrical outlet.

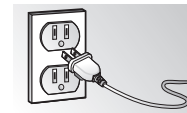

● Step 7: Running a test cycle

Run a test cycle as follows to check if your washer is properly installed.

1. Load about **5** pounds of laundry into the tub.
2. Press the **Power** button to turn on your washer.
3. Select the **Rinse+Spin** cycle by pressing the **Function** to turn ON the **Rinse** and **Spin** lights.
4. Press the **Start/Pause** button to start the test cycle.
5. The washer should not rock or vibrate excessively when water is supplied or when washing or spinning, and should drain well during the spin cycle.



If water leaks while water is being supplied or drained, check the water connections.

If the washer rocks and vibrates excessively, level your washer again.

● Step 8: Storing your washer

If you want to store your washer at another location, unplug it, drain any remaining water from the drain pipe and hook the pipe onto the back of the washer. Disconnect the water inlet hoses from the faucets and move washer to new location.

How To Use

Control Panel

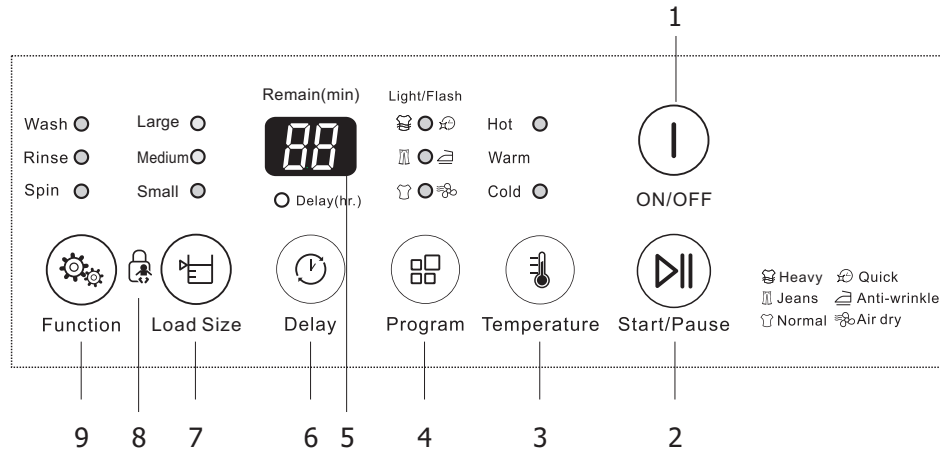

1 - ON/OFF

Press the **ON/OFF** button once to turn ON the power of the washer. Press again to turn OFF the unit.

2 - START/PAUSE

Press the **START/PAUSE** button once to start the wash cycle. Press the button during operation to pause the cycle. Press again to continue the cycle.

3 - Temperature

Press this button to select water temperature for washing.
 Cold light only indicates Cold Water selection
 Both Cold and Hot light together indicate Warm Water selection
 Hot light only indicates Hot Water selection

4 - Program

Press this button to select your desired washing program.

Heavy (light)	Quick (Flash)
Jeans (light)	Anti-wrinkle (Flash)
Normal (light)	Air dry (Flash)

5 - Digital display

The digital display will show and count down the estimated minutes for the wash cycle selected. Or, if Delay Start is set, the display will count down the hours until the cycle begins, and then change to a minute countdown for the wash cycle.

6 - Delay

Press this button to set your desired time to delay start the washer.

How To Use

7 - Load Size

Press this button to set your washing load size. Your setting will decide the water level throughout all steps in the cycle.

8 - CONTROL LOCK

The control lock function can help to prevent children from changing the operation status of the unit.

9 - Function

Press this button to select cycle steps included in your setting cycle. The related light will be ON indicating that the step is selected. Normally, all **Wash**, **Rinse** and **Spin** steps are included with all lights ON.

Washing a load of laundry

• Step 1: Power on your washer



Press the **ON/OFF** button to power your wash on.

• Step 2: Load your washer



Before loading your laundry, be sure to take out coins, keys and other hard objects, and close all zippers to prevent the clothes from damage.



Sort laundry by fabric type, soil level, color and load size as needed. Refer to the Fabric Care Chart in the APPENDIX. You can fill the tub with dry, unfolded clothes, but DO NOT OVERLOAD the tub. Load the tub no more than 3/4 full.



• Step 2: Load your washer

To ensure good cleaning results do not overload the tub, especially when washing heavily soiled loads. Never load the tub more than 3/4 full.



Overloading may reduce washing efficiency, cause excess wear, and possibly cause creasing or wrinkling of items in the load.

Note: To add a forgotten item:

1. Press the **START/PAUSE** button to pause the washer.
2. Wait for the tub to stop turning, then open the door.
3. Add the item, close the door, and then press the **START/PAUSE** button. The cycle will resume.

How To Use

Washing a load of laundry

• Step 3: Add detergent

This washer is designed for high efficiency (HE) powder detergent only. Draw the compartment out and add the recommended amount of detergent directly into the detergent compartment before starting your washer. The normal amount of detergent to use is 1/4 to 1/2 of the maximum amount recommended by the detergent manufacturer. Always reduce the amount of detergent if the load is small or lightly soiled, or if your water is very soft. Never use more than the maximum amount recommended by the detergent manufacturer.

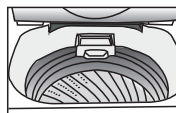

Never pour any liquid bleach directly onto the load. It can cause fabric damage, such as weakening of cloth fibers or color loss.

• Step 4: Select your desired cycle and options

Light/Flash



First, select your desired washing program.



Heavy (light) Quick (Flash)



Jeans (light) Anti-wrinkle (Flash)



Normal (light) Air dry (Flash)



Program

The **Air Dry** cycle can help remove some moisture from clothing to reduce drying time and cost.

Large ●

Medium ●

Small ●



Load Size

Second, select the water level based on a High, Medium or Low load size. Press the Load Size button to change the water level setting.

Wash ●

Rinse ●

Spin ●



Function

Third, select your desired wash cycle steps. If you want the wash cycle to perform all three steps, just keep them lighted. Pressing the button will change the number of steps performed. In addition to **Wash / Rinse / Spin** you can select **Wash / Rinse , Rinse / Spin , Wash , or Spin .**

Hot ●

Warm

Cold ●



Temperature

Fourth, select your desired water temperature for washing action. For some cycles, options in this function will be limited accordingly.

Cold light only indicates Cold Water selection

Both Cold and Hot light together indicate Warm Water selection

Hot light only indicates Hot Water selection

Note: The temperature setting is just for washing action. Rinsing action is cold water only for all cycles.

How To Use

Washing a load of laundry

Remain(min)



● Delay(Hr.)



Delay

Last, you may delay the start time for washing if desired. Press the **Delay** button. The display will change from minutes to hours. Each further press of the **Delay** button will add 1 hour to the display up to 24 hours.

Now each further press will add 6 hours to the display up to 48 hours. One more press will cancel the **Delay** function and the display light will turn off.

• Step 5: Start the cycle



Start/Pause

Press the **START/PAUSE** button to start the washing cycle. When the washing cycle begins, the Estimated Time in minutes for the cycle to complete will show and count down in the digital display. Or, if Delay Start is set, the display will count down the hours until the cycle begins, and then change to a minute countdown for the cycle.



When the washer is running, you should pause the program and wait for the basket stopped completely before you open the door.

Note:

If you want to cancel the **Delay Start** function after it is started, you should power off the unit and reset all functions before restart the unit.

Control lock



This function is useful to prevent children from changing the operation status of the unit.



Function



Load Size

Press and hold the "**Function**" and "**Load Size**" buttons simultaneously to activate this function.

The digital display will show "**CL**". The "**CL**" and remaining time or Delay Start time will be displayed in turn .

Remain(min)



Press and hold the "**Function**" and "**Load Size**" buttons simultaneously again to deactivate this function.

The "**CL**" display will disappear with only remaining time or Delay Start time displayed.

When Control Lock is activated, no buttons will function except for **POWER** and the ability to deactivate **Control Lock** as described above.

How To Use

Cycle Guide

Program	Load Size		Wash Time (about) including soak time	Rinse Times	Final Spin Time	Total Time
	Default	Scope				
Heavy	Large	Sm, Med, Lg	12 min	2	5min	42min
Quick	Large	Sm, Med, Lg	3 min	1	30sec	10min
Jeans	Large	Sm, Med, Lg	17 min	2	1 min 10sec	42min
Anti-wrinkle	Large	Sm, Med, Lg	12 min	2	—	34min
Normal	Large	Sm	16 min	1	5min	36min
		Med	18 min	1	7min	44min
		Lg	21 min	1	10min	50min
Air dry	Large	—	—	—	57min	60min

Energy efficiency test program :

"Normal" program is the most suitable program to wash soiled cotton or linen clothes and is the most efficient program in terms of combined energy and water consumption for washing that type of laundry.

Care And Cleaning

Regular Cleaning and Maintenance

● Cleaning the exterior

Turn off the water faucets after finishing the day's washing. This will shut off the water supply to your washer and prevent the unlikely possibility of damage from escaping water. Leave the lid open to allow the inside of your washer to dry out. Use a soft cloth to wipe up all detergent, bleach or other pills as they occur. Clean the following as recommended:
Control Panel - Clean with a soft, damp cloth. Do not use abrasive powders or cleaning pads. Do not spray cleaners directly onto the panel.

● Cleaning the interior

Clean the interior of your washer periodically to remove any dirt, soil, odor, mold, mildew, or bacterial residue that may remain in your washer as a result of washing clothes. Failure to follow these instructions may result in unpleasant conditions, including odors and/or permanent stains on your washer or laundry. Hard water deposits may be removed, if needed. Use cleaners labeled "Washer safe".

● Tub clean

Run an Express cycle with some bleach every month to clean the tub. This will also help to remove mold which may occur inside the washer.

● Lint filter clean

There is a built-in lint filter in your washer. It can help to collect lint during washing cycle. It is suggested to clean the lint filter every 10 cycles. Take it out and clean the filter with water. Then place it back into the washer.

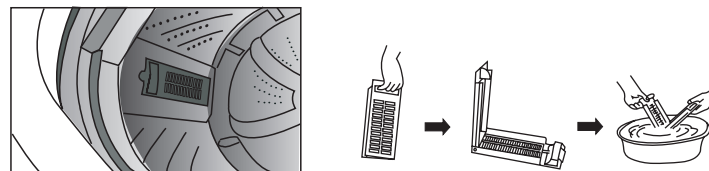

● Pump filter clean

There is a built-in Pump filter in your washer. It can help to protect the pump during washing cycle. It is suggested to clean the lint filter every once every month. It is suggested to clean the pump filter once every month. Take the filter out and clean it with water. Then place it back into the washer.

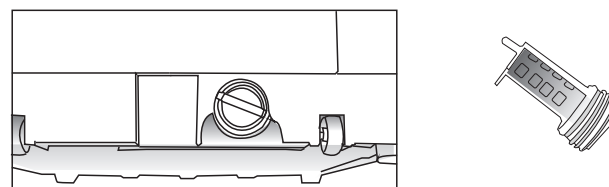

Troubleshooting

Before calling for service

Your washing machine is equipped with an automatic error-monitoring system to detect and diagnose problems at an early stage. If your washer does not function properly or does not function at all, check the following before you call for service:

Problem	Possible Cause	Solutions
Thumping sound	Heavy wash loads may produce a thumping sound. Washer load may be out of balance.	This is normal. If sound continues, washer is probably out of balance. Stop and redistribute wash load. Pause the cycle and redistribute the load.
Vibrating noise	Packaging materials were not removed. Wash load may be unevenly distributed in the tub. Not all leveling feet are resting firmly and evenly on the floor. Floor not rigid enough.	See the UNPACKING AND REMOVING SHIPPING MATERIAL section in the installation instructions. Pause the cycle and redistribute the load. See Leveling the Washer in the Installation Instructions. Make sure that the floor is solid and does not flex. See Flooring in the Installation Requirements.
Excessive sudsing	Too much detergent or incorrect detergent.	HE detergents are formulated specifically for High-Efficiency washers and contain suds reducing agents. Only use detergent with the High-Efficiency (HE) logo.
Water leaking	Inlet hose connection is loose at faucet or washer. House drain pipes are clogged. Drain hose has come out of drain or is not inserted far enough. A large item such as a pillow or blanket is above the top of the tub.	Check hoses for leaks, cracks and splits. Check and tighten hose connections. The washer pumps out water very rapidly. Check for water backing up out of the drain pipe during drain. If water is seen coming out of the drain, check for proper drain hose installation and check for restrictions in the drain. Contact a plumber to repair drain pipe. Tie drain hose to inlet hose or standpipe to prevent it from coming out during drain. For smaller drain pipes, insert the drain hose into the pipe as far as the drain hose flange. For larger drain pipes, insert the drain hose into the pipe 1–2 in. past the flange. Stop the washer and check the load. Make sure the load does not crest above the top edge of the tub.

Troubleshooting

Before calling for service

Problem	Possible Cause	Solutions
Rattling and clanking noise	Foreign objects, such as keys, coins, or safety pins, may be in tub or pump.	Stop washer, check tub and drain filter for foreign objects. If noise continues after washer is restarted, call for service.
Wrinkling	Washer not unloaded promptly. Washer overloaded. Hot and cold water inlet hoses are reversed.	Always remove items from the washer as soon as the cycle is complete. The washer can be fully loaded, but the tub should not be tightly packed with items. The lid of the washer should close easily. Hot water rinse can set wrinkles in garments. Check the inlet hose connections.
Staining	Washer was not unloaded promptly. Clothes were not properly sorted.	Always remove items from the washer as soon as possible after the cycle is complete. Always wash dark colors separately from light colors and whites to prevent discoloration. Never wash heavily soiled items washed with lightly soiled items.
Wash cycle time is longer than usual	The washer automatically adjusts the wash time for the amount of laundry, water pressure and other operating conditions.	This is normal. The washer adjusts cycle time automatically to provide optimal results for the selected cycle. The time remaining shown in the display is only an estimate. Actual time may vary.
Musty or mildewy odor in washer	Incorrect or too much detergent has been used .Inside of tub was not cleaned properly.	Use only High-Efficiency (HE) detergent in accordance with the manufacturer's instructions. Run an Express cycle with bleach once a month to clean tub and remove any mold from inside washer.

Troubleshooting

Before calling for service

Problem	Possible Cause	Solutions
<p>Washer will not turn ON</p> <p>NOTE: If the washer stopped during a cycle due to a loss of power, the washer will resume the cycle where it stopped when the power is restored.</p>	<p>Power cord is not properly plugged in.</p> <p>House fuse is blown, circuit breaker has tripped, or power outage has occurred.</p> <p>House fuse is blown, circuit breaker has tripped, due to multiple appliances on one outlet.</p>	<p>Make sure that the plug is plugged securely into a grounded, 3-prong, 120-VAC, 60-Hz outlet.</p> <p>Reset circuit breaker or replace fuse. Do not increase fuse capacity. If the problem is a circuit overload, have it corrected by a qualified electrician.</p> <p>Reset circuit breaker or replace fuse. If more than one appliance is connected to the outlet, call an electrician to have an additional circuit installed.</p>
Water leaks	Over sudsing of detergent.	<p>Over sudsing may create leaks, and may be caused by the type and amount of detergent used.</p> <p>High-Efficiency detergent is the only detergent recommended. Make sure that detergent and any additives are put into the correct dispenser compartments.</p> <p>The normal amount of detergent to use is 1/4 to 1/2 of the maximum amount recommended by the detergent manufacturer. Always reduce the amount of detergent if the load is small or lightly soiled, or if your water is very soft.</p> <p>Never use more than the maximum amount recommended by the detergent manufacturer.</p>
Poor stain removal	Previously set stains.	Articles that have previously been washed may have stains that have been set. These stains may be difficult to remove and may require hand washing or pre-treating to aid in stain removal.

Troubleshooting

Before calling for service

Problem	Possible Cause	Solutions
Washer will not drain water	Kinked drain hose. Drain located higher than 48 in. above the floor.	Ensure that the drain hose is not kinked. Make sure that the drain hose is no higher than 4 ft. above the bottom of the washer and is no more than 5 ft. away from the washer.
Washer will not operate	<p>Water supply is turned off.</p> <p>Control panel has powered off due to inactivity.</p> <p>Washer is unplugged.</p> <p>Controls are not set properly.</p> <p>Lid is open.</p> <p>Circuit breaker/fuse is tripped/blown.</p> <p>Control needs to be reset.</p> <p>START/PAUSE was not pressed after a cycle was set.</p> <p>Extremely low water pressure.</p> <p>Washer is too cold.</p> <p>Washer is running under Delay start program.</p>	<p>This is normal. Press the POWER button to turn the washer on.</p> <p>Make sure cord is plugged securely into a working outlet.</p> <p>Turn both hot and cold faucets fully on. Make sure the cycle was set correctly, close the lid and press the START/PAUSE button.</p> <p>The washer will not operate if the lid is open. Close the lid and make sure that nothing is caught under the lid preventing it from closing completely.</p> <p>Check house circuit breakers/fuses. Replace fuses or reset breaker. The washer should be on a dedicated branch circuit. The washer will resume the cycle where it stopped once power is restored.</p> <p>Press the POWER button, then re-select the desired cycle and press the START/PAUSE button.</p> <p>Press the POWER button then re-select the desired cycle and press the START/PAUSE button. The washer will shut off if the START/PAUSE button is not pressed within ten minutes.</p> <p>Check another faucet in the house to make sure that household water pressure is adequate.</p> <p>If the washer has been exposed to temperatures below freezing for an extended period of time, allow it to warm up before pressing the POWER button. Otherwise, the display will not come on.</p> <p>It's normal if the unit doesn't operate under Delay start function. It will start automatically after the delay time is out.</p>

Troubleshooting

Before calling for service

Problem	Possible Cause	Solutions
Washer not filling properly	Filter clogged. Inlet hoses may be kinked Insufficient water supply. The washer lid is open. Hot and cold inlet hoses are reversed. Water level is too low. Water inlet valve damaged.	Disassemble the water inlet hose and clean the inlet point. Check that inlet hoses are not kinked or clogged. Make sure that both hot and cold water faucets are turned on all the way. The washer will not operate if the lid is open. Close the lid and make sure that nothing is caught under the lid preventing it from closing completely. Check inlet hose connections. Make sure the hot water supply is connected to the hot inlet valve, and the cold water supply is connected to the cold inlet valve. This is a high efficiency washer. The water will not normally cover the clothes. The fill level is optimized for the wash motion to achieve the best wash performance. Call to the service center for service.
Water leaks every load	Hoses not installed correctly.	Check all fill and drain hose connections to ensure that they are tight and secure.



































Error Codes

Error Code	Possible Cause	Solutions
E1	It takes over 30 minutes to fill water but cannot achieve its preset water level.	Check for Washer not filling properly and Water leakage.
E2	The top lid is open.	Close the lid.
E3	The washer runs out of balance for three times.	Redistribute the load.
E4	It takes over 10 minutes to drain water but can not drain the washer empty.	Check for Washer will not drain water.
E5	The water fills too much to exceed its preset level.	Call to service center for help.

APPENDIX

Fabric Care Chart

The following symbols provide garment care direction. The Clothing care labels include symbols for washing, bleaching, drying and ironing, or dry cleaning when necessary. The use of symbols ensures consistency among garment manufacturers of domestic and imported items. Follow care label directions to maximize garment life and reduce laundering problems.

Wash Cycle	Special Instructions	Warning Symbols for laundering
 Normal	 Line Dry/Hang to Dry	 Do Not Wash
 Permanent Press / Wrinkle Resistant / Wrinkle Control	 Drip Dry	 Do Not Wring
 Gentle/Delicates	 Dry Flat	 Do Not Bleach
 Hand Wash	Heat Setting	 Do Not Tumble Dry
Water Temperature**	 High	 No Steam (added to iron)
 Hot	 Medium	 Do Not Iron
 Warm	 Low	Dryclean
 Cold	 Any Heat	 Dry Clean
Bleach	 No Heat/Air	 Do Not Dry Clean
 Any Bleach (when needed)	Iron-Dry or Steam Temperatures	 Line Dry/ Hang to Dry
 Only Non-Chlorine (color-safe) Bleach (when needed)	 High	 Drip Dry
 Tumble Dry Cycle	 Medium	 Dry Flat
Normal	 Low	 For machine-washable wool. Loads should be under 8 pounds.
 Permanent Press / Wrinkle Resistant / Wrinkle Control		
 Gentle/ Delicates		

** The number of dots represent appropriate wash water temperatures for various items. The temperature range for Hot is 105°-125°F/41°-52°C, for Warm 85°-105°F/29°-41°C and for Cold 60°-85°F/16°-29°C. (Wash water temperature must be a minimum of 60°F/16°C for detergent activation and effective cleaning.) The clothes washer can not ensure these temperatures because the actual temperature of the water entering your washer depends on water heater settings and regional water supply temperatures. For example, cold water entering the home in the northern states during winter may be 40°F/4°C which is too cold for effective cleaning. In this situation, you will need to adjust the water temperature by selecting a warm setting, adding some hot water to the MAX FILL line, or using your Washer's heating option, if available.

LIMITED WARRANTY

We warrants each new Washing Machine to be free from defects in material and workmanship, and agrees to remedy any such defect or to furnish a new part(s), at the company's option, for any part(s) of the unit that has failed during the warranty period. Parts and labor expenses are covered on this unit for a period of one year from the date of purchase. A copy of the dated sales receipt or invoice is required to receive warranty service by an authorized service agent.

This warranty covers appliances in use within the continental United States, Puerto Rico, Hawaii, and Canada. The warranty does not cover the following:

- Damages due to shipping damage or improper installation.
- Damages due to misuse or abuse.
- Content losses due to failure of the unit.
- Inside components such as filters, etc.
- Repairs performed by unauthorized service agents.
- Service calls that do not involve defects in material and workmanship such as instructions on proper use of the product or improper installation.
- Replacement or resetting of house fuses or circuit breakers.
- Failure of this product if used for other than for its intended purpose.
- Disposal costs for any failed unit not returned to our factory.
- Any delivery costs incurred as the result of a unit that fails to perform as specified.
- Expenses for travel and transportation for product service if your appliance is located in a remote area where service by an authorized service technician is not available.
- The removal and reinstallation of your appliance if it is installed in an inaccessible location or is not installed in accordance with published installation instructions.

Limitations of Remedies and Exclusions:

Product repair in accordance with the terms herein, is your sole and exclusive remedy under this limited warranty. Any and all implied warranties including merchantability and fitness for a particular purpose are hereby limited to one year or the shortest period allowed by law. We are not liable for incidental or consequential damages and no representative or person is authorized to assume for us any other liability in connection with the sale of this product. Under no circumstances is the consumer permitted to return this unit to the factory without prior written consent of us.

Some states prohibit the exclusion or limitation of incidental or consequential damages, or limitations on implied warranties. This warranty gives you specific legal rights, and you may also have other rights which vary from state to state.

**Parts
One-Year**

**Labor
One-Year**

**Type of Service
In Home**

For Service or Assistance, please call 1-866-646-4332.