

Thank you for selecting Globe as your lighting choice for your home. With proper care, this product will provide years of pleasure and enjoyment. Carefully follow the instructions in order to ensure that this product functions safely and properly for years to come.

## VIBRANCE® RECESSED LIGHTING

### FOR YOUR SAFETY

Most electrical accidents are caused by carelessness or ignorance. If you combine a basic knowledge of electricity, a healthy respect for it, and a dose of common sense, you can safely tackle many household electrical repairs. Here are some basic guidelines for working with electricity:



Use tools with insulated handles and ladders made of wood or fiberglass.

To protect children, place safety covers over any unused outlets.

When unplugging a power tool or appliance, pull on the plug, not on the power cord.

Before working on a circuit, go to the main service panel and remove the fuse or trip the breaker that controls that circuit. Tape a sign to the panel warning others to leave the circuit alone while you work.

Improperly used extension cords are a leading cause of electrical fires. They are for temporary use only - do not use them to extend a circuit permanently.

Before touching any wire, use a voltage tester to make sure it's not live.

Keep dry-chemical fire extinguishers in the kitchen, basement, and workshop.

Whenever you check for voltage in a receptacle, check both outlets – each may be controlled by a separate wiring circuit.

Never disable grounding devices. Make sure that all appliances requiring grounding are properly grounded, and that the electrical system itself is properly grounded.

When replacing fuses, turn off the main power first. Make sure your hands and feet are dry, and place one hand behind your back to prevent electricity from making a complete circuit through your chest. Touch a plug fuse only by its insulated rim. Remove cartridge fuses with a fuse puller.

Meet or exceed all electrical code requirements that cover the work you are doing.

Always work with enough light to see what you are doing; it's easy to make mistakes when you're working in dim light.

When in doubt about the safety of any electrical repair or test, call in a professional.

### ELECTRICAL INSTALLATION

FIG. 1. Place the wall switch to the "OFF" position.

Depending on which type of fuse box you have in your home:

FIG. 2. Place either the main (Master) switch to the "OFF" position, cutting off power to your entire home OR turn off the individual switch that provides power to where the fixture will be installed.

OR

FIG. 3. Place either the main (Master) switch to the "OFF" position, cutting off power to the entire home OR unscrew the fuse that provides power to where the fixture will be installed.

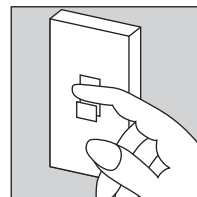

FIG. 1  
WALL SWITCH

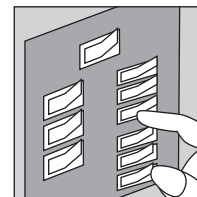

FIG. 2  
BREAKER PANEL

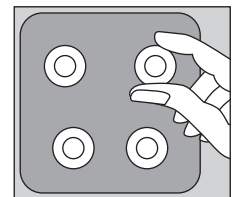

FIG. 3  
FUSE BOX

Since 1932, Globe has taken pride in offering products of the highest quality, and a level of service unparalleled in the industry. Should you encounter any difficulties, have any questions or simply wish to offer us your valuable feedback, you may contact us in the following ways:

Toll Free Telephone: 1-800-361-6761 (North America Only) / Toll Free Fax: 1-800-668-4562 (North America Only)

E-Mail: [info@globe-electric.com](mailto:info@globe-electric.com) / Mail: Globe Electric Customer Service Department

150 Oneida, Montreal, Quebec, Canada H9R 1A8

Please visit our website to discover other quality Globe products: <http://www.globe-electric.com>

# INSTRUCTIONS

## VIBRANCE LIGHTING KIT INCLUDES:

- (1) housing can
- (1) convex glass
- (1) template

## SAFETY PRECAUTION:

Before assembling your lighting fixture, **TURN OFF POWER** and consult a qualified licensed electrician. All insulation must remain at least 3" (7.6 cm) away from housing can at all times.

## HOUSING INSTALLATION:

### Step 1: Cut hole

Mark the appropriate openings for the lighting fixtures in the desired locations using the template included on the box. Cut the openings using a drywall saw.

### Step 2: Connect the wires

If you do not have electrical wiring experience, Globe recommends consulting a qualified licensed electrician who will ensure the fixture is installed in accordance with local installation codes.

### Step 3: Place housing through hole

Lift the housing through the opening in the drywall.

### Step 4: Push-N-Click

Using your hand push and click the clips in place, adjusting the height where needed for a superior fit.

### Step 5: Add trim

Install the accompanied trim and bulb (sold separately). See bulb assembly instructions below.

STEP 1

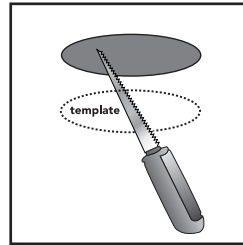

STEP 2

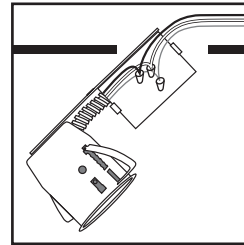

STEP 3

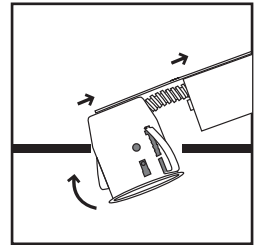

STEP 4

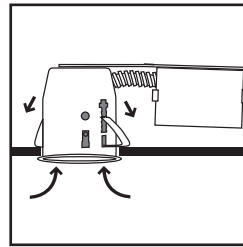

STEP 5

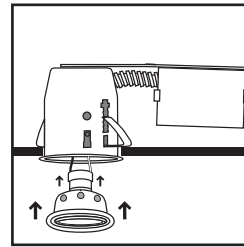

DIAGRAM A

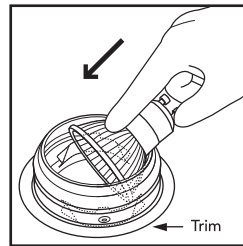

DIAGRAM B

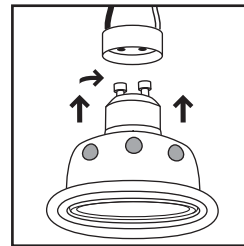
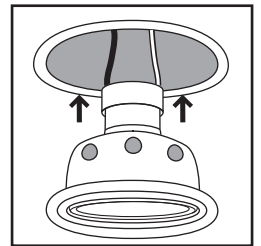

DIAGRAM C



## BULB ASSEMBLY

1. Refer to box for recommended maximum wattage. **DO NOT EXCEED RECOMMENDED MAXIMUM WATTAGE.**
2. Bulbs are to be loaded from back of trim and will be held securely in place by spring clips. See *diagram A*
3. Once secured in trim, connect base of bulb into socket attached to the fixture. See *diagram B*
4. Insert entire assembly into recessed housing. See *diagram C*

## MAINTENANCE

1. This unit is intended for indoor use only.
2. This unit is designed for use in damp locations.
3. Do not modify this fixture. If any modifications are made it may render the product unsafe and void warranty.
4. Cleaning: Before cleaning your fixture, turn off the switch or power source. Wipe the lamp with a soft, damp cloth.

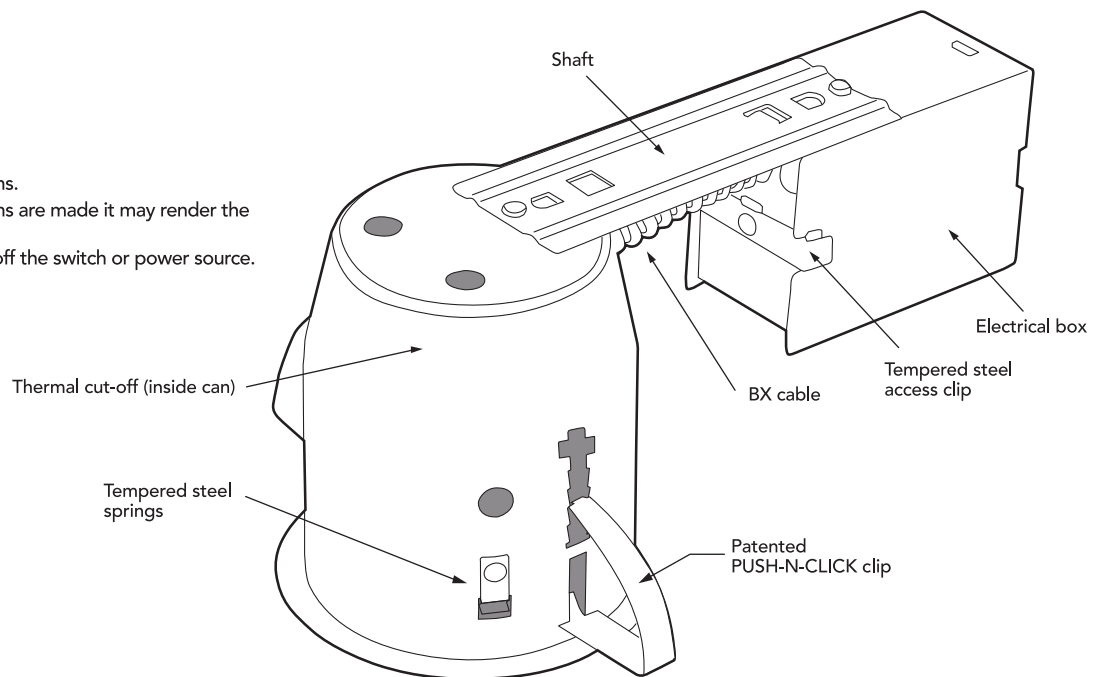

## 4" SPECIALTY RECESSED SHOWER LIGHT KIT 35W GU10 replacement bulb (sold separately)

APPLICABLE WITH THE FOLLOWING MODELS:  
90025 / 90026 / 90027

FOR USE IN NON-INSULATED CEILINGS.  
FOR INSULATED CEILINGS, THIS LUMINAIRE SHALL BE  
INSTALLED WITH TYPE-IC BOX MODEL 90117 (400) or  
90127 (NM400) FOR CONVERTIBLE RECESSED  
LUMINAIRES (NOT INCLUDED).

DESIGN AND COLOR MAY VARY  
DEPENDING ON THE STYLE PURCHASED.