

INSTALLATION INSTRUCTIONS

Ventilating Fan

Model No. FV-0810RSL1

Contents

GENERAL SAFETY INFORMATION	2-3
DESCRIPTION	4
UNPACKING	4
SUPPLIED ACCESSORIES	5
DIMENSIONS	5
WIRING DIAGRAM	6
FEATURE	6
INSTALLATION I (JOIST MOUNTING)	7-9
INSTALLATION II (WALL MOUNTING)	9
MAINTENANCE (CLEANING)	10
PRACTICAL GUIDE TO INSTALLATION	11
SPECIFICATIONS	11
PRODUCT SERVICE	12

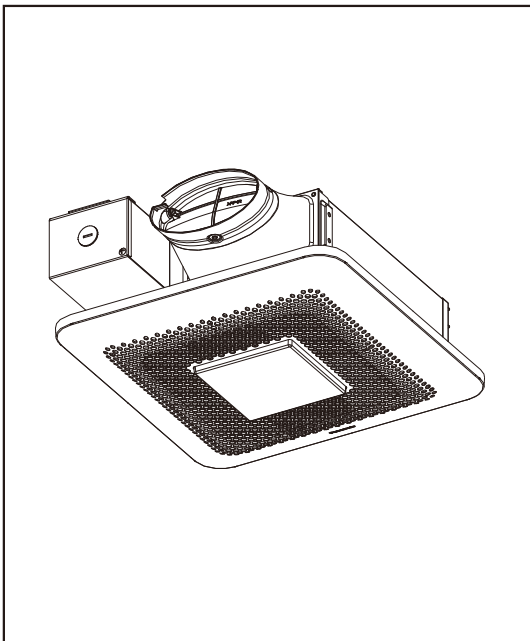

READ AND SAVE THESE INSTRUCTIONS

Thank you for purchasing this Panasonic product.

Please read these instructions carefully before attempting to install, operate or service the Panasonic product. Failure to comply with instructions could result in personal injury or property damage. Please explain to users how to operate and maintain the product after installation, and this booklet should be presented to users.

Please retain this booklet for future reference.

GENERAL SAFETY INFORMATION

For Your Safety

To reduce the risk of injury, loss of life, electric shock, fire, malfunction, and damage to equipment or property, always observe the following safety precautions.

Explanation of symbol word panels

The following symbol word panels are used to classify and describe the level of hazard, injury, and property damage caused when the denotation is disregarded and improper use is performed.



Denotes a potential hazard that could result in serious injury or death.











Denotes a hazard that could result in minor injury.

The following symbols are used to classify and describe the type of instructions to be observed.

	This symbol is used to alert users to a specific operating procedure that must be followed in order to operate the unit safely.
	This symbol is used to alert users to a specific operating procedure that must not be performed.
	This symbol is used to alert users not to disassemble the equipment.
	This symbol is used to alert users to make sure of grounding when using the equipment with the grounding terminal.











TO REDUCE THE RISK OF FIRE, ELECTRIC SHOCK OR INJURY TO PERSONS, OBSERVE THE FOLLOWING :

-  Use this unit only in the manner intended by the manufacturer. If you have any questions, contact the manufacturer.
-  Before servicing or cleaning unit, switch power off at service panel and lock the service disconnecting means to prevent power from being switch on accidentally. When the service disconnecting means cannot be locked, securely fasten a prominent warning device, such as a tag, to the service panel.
-  Installation work and electrical wiring must be done by qualified person(s) in accordance with all applicable codes and standards, including fire-rated construction.
-  Sufficient air is needed for proper combustion and exhausting of gases through the flue (chimney) of fuel burning equipment to prevent back drafting. Follow the heating equipment manufacturer's guideline and safety standards such as those published by the National Fire Protection Association (NFPA), and the American Society for Heating, Refrigeration and Air Conditioning Engineers (ASHRAE) and the local code authorities.
-  When cutting or drilling into wall or ceiling, do not damage electrical wiring and other hidden utilities.
-  Ducted fans must always be vented to the outdoors.
-  If this unit is to be installed over a tub or shower, it must be marked as appropriate for the application and be connected to a GFCI (Ground Fault Circuit Interrupter) - protected branch circuit.
-  This model is UL listed for tub and shower enclosures.

GENERAL SAFETY INFORMATION CONTINUED

WARNING

-  Not to be installed in a ceiling thermally insulated to a value greater than R60.
-  Do not disassemble the unit for reconstruction. It may cause fire or electric shock.
-  A statement to the effect that when the product is to no longer be used, it must not be left in place but removed, to prevent it from possible falling.
-  Ceiling joist or wall stud must be subjected to static load more than five times the weight of the product.
-  Do not install with a method which is not approved in the instructions.
-  Do not use this fan with any solid-state speed control device. Solid state controls may cause harmonic distortion which can cause motor humming noise.
-  Install the fan at least 1.5 m (5 feet) above the floor, and the fan must be installed above a counter or major appliances that serves as a barrier.
-  This product must be properly grounded.
-  When one switch is connected with two or more products in parallel, the unit may not function. Therefore, parallel connection must not be allowed.

CAUTION











-  Do not install this ventilating fan where interior room temperature may exceed 104 °F (40 °C).
-  Make sure that the electric service supply voltage is AC 120 V, 60 Hz.
-  Follow all local electrical and safety codes, as well as the National Electrical Code (NEC) and the Occupation Safety and Health Act (OSHA).
-  Always disconnect the power source before working on or near the fan, motor, light fixture or junction box.
-  Protect the supply wiring from sharp edges, oil, grease, hot surfaces, chemicals or other objects.
-  Do not kink the supply wiring.
-  Provide make up air for proper ventilation.
-  For general ventilating use only. Do not use to exhaust hazardous or explosive materials and vapors.
-  Do not install the unit where ducts are configured as shown in Fig.A.
-  Not for use in cooking area. (Fig.B)
-  The special-purpose or dedicated parts, such as mounting fixtures, must be used if such parts are provided.



Fig. A

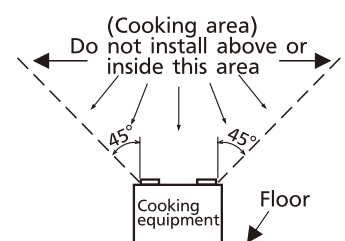

Fig. B

DESCRIPTION

The Panasonic ventilating fan model is listed by UL under UL file No. E78414. The Panasonic ventilating fan model uses a sirocco fan driven by a capacitor motor. The motor is designed to have an extended service life with reduced energy consumption. It also incorporates a thermal-cutoff for safety. The grille covering the fan body is a spring-loaded, quick remove type. A damper for preventing air counterflow is provided. The blower uses a high-capacity sirocco fan developed to reduce the noise level. This product has two speeds. "80" is low airflow and "100" is high airflow. The lighting unit is an energy-saving LED lighting device that uses one 10 W LED lamp and produces almost the same illumination as a standard 40 W incandescent lamp.

FCC Note: This equipment has been tested and found to comply with the limits for a Class B digital device, pursuant to Part 15B of the FCC Rules. These limits are designed to provide reasonable protection against harmful interference in a residential installation. This equipment generates, uses and can radiate radio frequency energy and, if not installed and used in accordance with the instructions, may cause harmful interference to radio communications. However, there is no guarantee that interference will not occur in a particular installation. If this equipment does cause harmful interference to radio or television reception, which can be determined by turning this product on and off, the user is encouraged to try to correct the interference by one of the following measures:

- Reorient or relocate the receiving antenna.
- Increase the separation between the equipment and receiver.
- Connect equipment into outlet on a circuit different from that to which the receiver is connected.
- Consult the dealer or an experienced radio/TV technician for help.

Warning: This equipment must be installed by qualified person in accordance with the provided installation instructions; and all applicable codes and standards. Also, any changes or modifications not expressly approved by the party responsible for compliance could void the user's authority to operate this equipment.

DoC Responsible Party: Panasonic Corporation of North America
Two Riverfront Plaza, Newark, NJ 07102

Customer Call Support: 1-866-292-7299

This device complies with Part 15B of the FCC Rules. Operation is subject to the following two conditions:



(1) This device may not cause harmful interference, and (2) this device must accept any interference received, including interference that may cause undesired operation.



Risk of Fire: Type IC-Inherently Protected.

UNPACKING

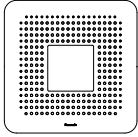
Unpack and carefully remove the unit from carton.
Refer to the supplied accessories list to verify that all parts are present.

SUPPLIED ACCESSORIES

Part name	Appearance	Quantity
Grille		1
Long screw (ST4.2×30)		5

Part name	Appearance	Quantity
Installation instructions		1
Warranty sheet		1

DIMENSIONS

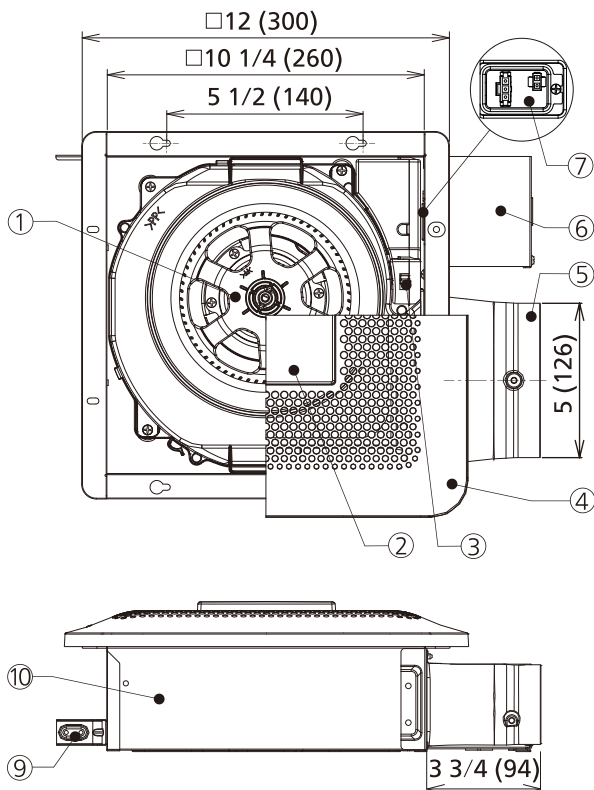

Unit: inches (mm)

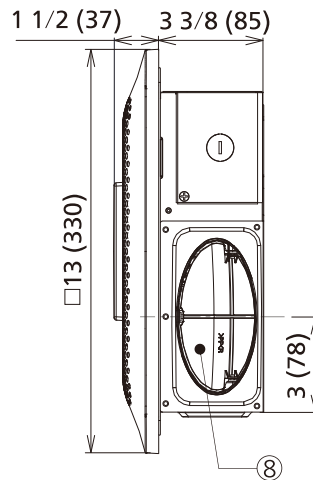

No.	Part name
①	Blade
②	LED lamp
③	Pick-A-Flow switch
④	Grille
⑤	Adaptor
⑥	Junction box
⑦	Connector plate
⑧	Damper
⑨	Suspension bracket
⑩	Fan body

WIRING DIAGRAM

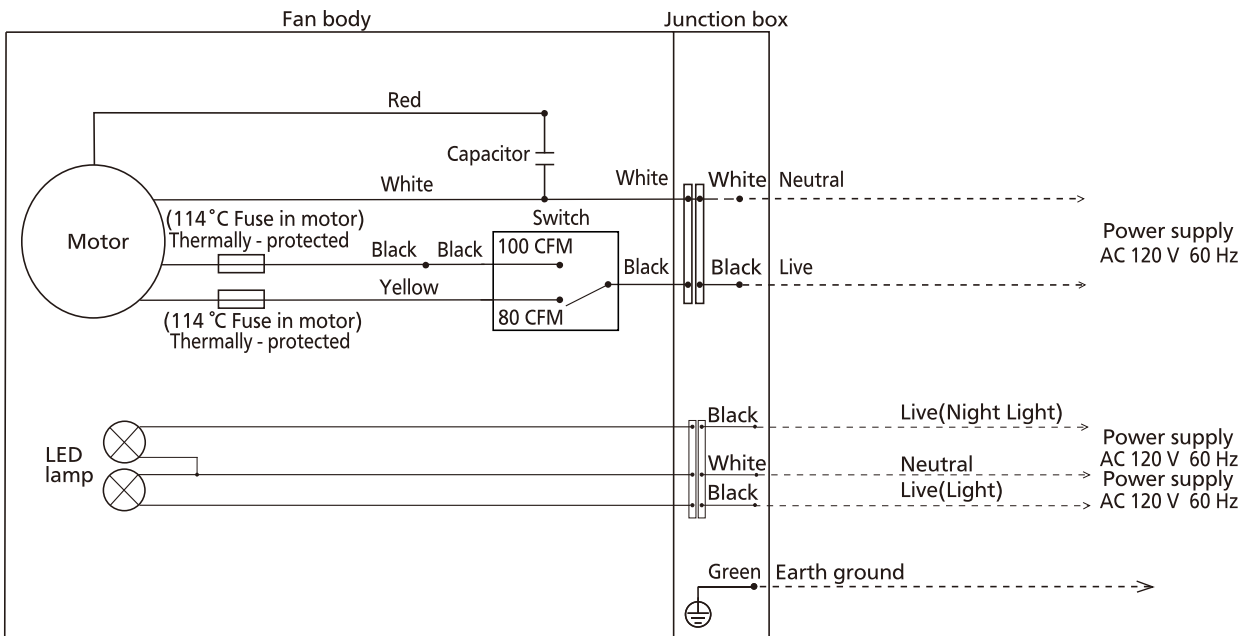

FEATURE

Pick-A-Flow Feature

This product comes with Pick-A-Flow speed option. The Pick-A-Flow switch on the surface of the product allows the option to choose 80-100 CFM.

Air volume options		Factory setting
80 CFM	100 CFM	80 CFM

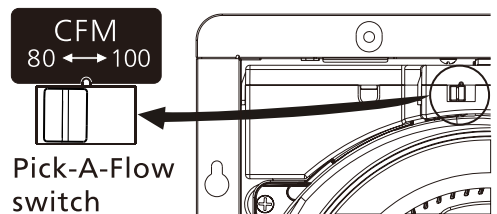

INSTALLATION I (JOIST MOUNTING)

CAUTION

! Please wear gloves to protect hands during the installation as follow.

1. Before installation, please remove the tape which protects damper during shipping and accessory screws from adaptor, then check that the damper can open and close smoothly.(Fig.1)
2. Fix the flange of frame to joist by 2 long screws(ST4.2x30), and fix the suspension bracket to joist by 2 long screws(ST4.2x30). (Fig.2)
- 3.Remove junction box cover and secure conduit or stress relief to junction box knock-out hole.(Fig.3)
- 4.Refer to wiring diagram(P.6), follow all the local electrical safety codes as well as the National Electrical Code(NEC). Using UL approved wire nuts, connect house power wires to ventilating fan wires.(Fig.3)

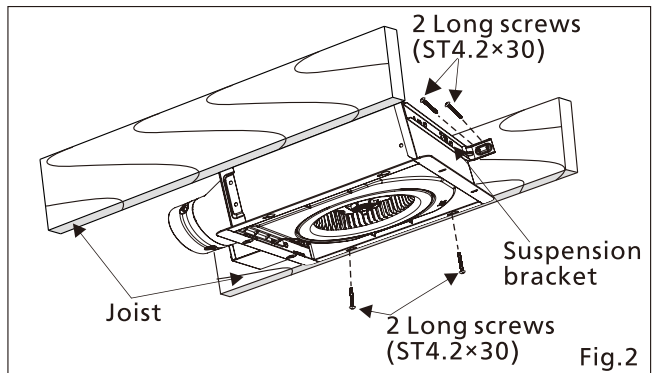
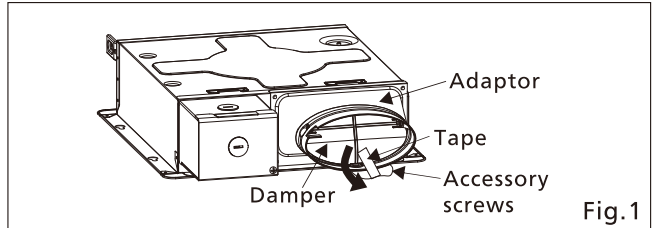

CAUTION

! The screws for fixing suspension bracket should not be replaced by other screws, otherwise the cord may be damaged and cause fire.

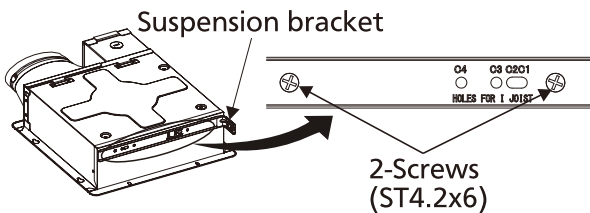

CAUTION

! Mount junction box cover carefully so that lead wires are not pinched.

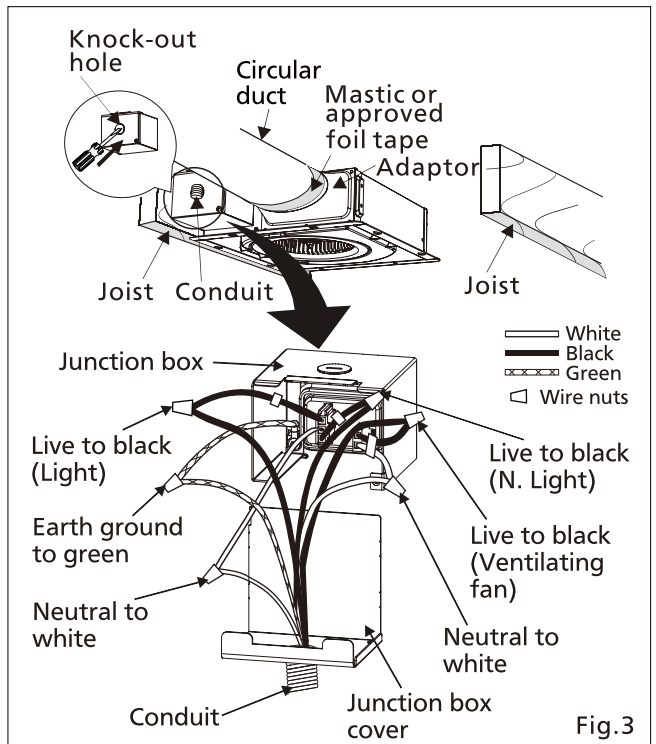

INSTALLATION I (JOIST MOUNTING) CONTINUED

5. A 4 inch circular duct is needed to connect to the relevant part of adaptor.

Squeeze a circular exhaust duct to fit the adaptor, then slip it onto adaptor and secure it with clamps, or ties and seal it with mastic or approved foil tape.

(Page 7 Fig.3)

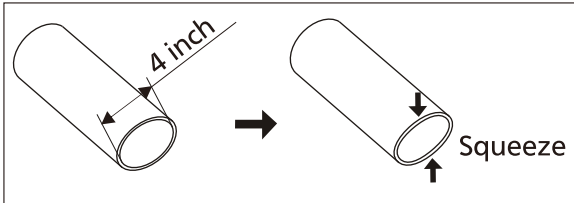

Note:

If using 3 inch round duct, please purchase the 26 gauge steel Panasonic 4" Oval - 3" Round Reducer from our representative.

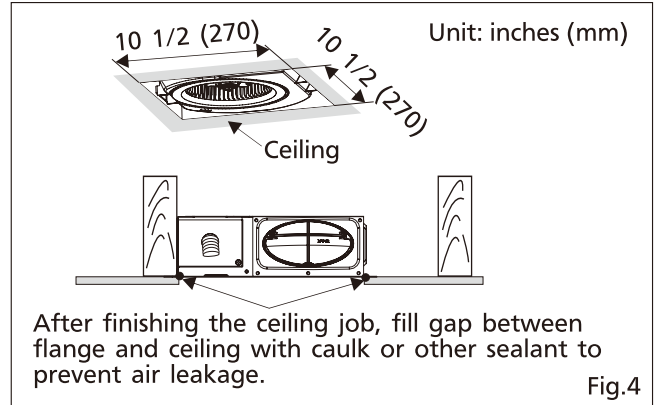

6. Finish ceiling work. Ceiling hole should be aligned with the inside edge of the flange. (Fig.4)

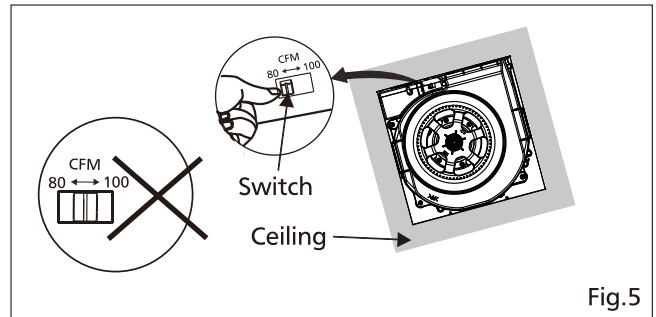

7. Select the air volume speed by adjusting the switch. Factory setting is "80" position; sliding "100" is high airflow position. (Fig.5)

8. Take out the mounting springs from clips. (Fig.6)

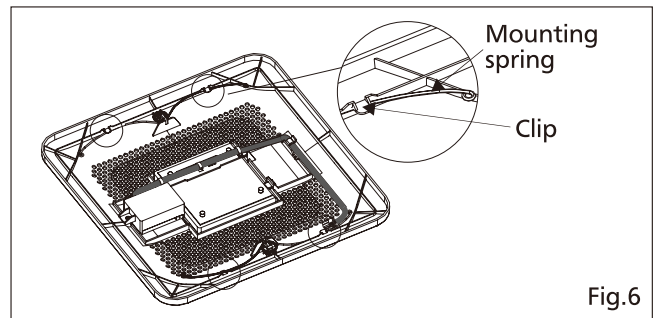

INSTALLATION I (JOIST MOUNTING) CONTINUED

9. Connect the LED lamp wire to fan body as show in Fig.7 ① .

10. Insert one mounting spring into slot as show in Fig.7 ② . (If not, the grille may not be installed.)

11. Insert the other mounting spring into slot as shown and mount grille to fan body. (Fig.8)

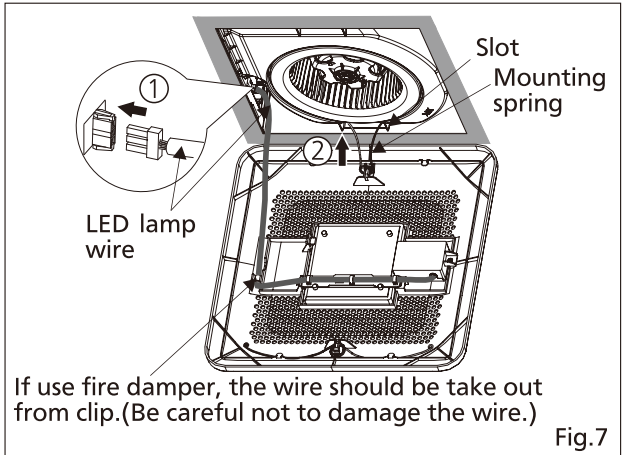

CAUTION

Mount grille carefully so that lead wire of lighting unit is not pinched.

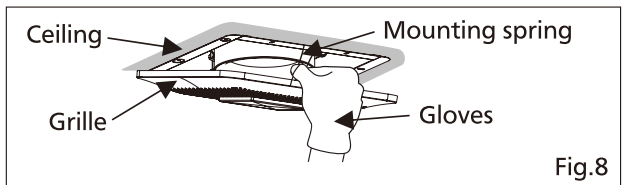

INSTALLATION II (WALL MOUNTING)

1. Before installation, please refer to step 1 to 2 of INSTALLATION I. (Page 7 fig.1)

2. Fix the flange of frame to stud by 2 long screws (ST4.2X30), and fix the suspension bracket to stud by 2 long screws (ST4.2X30). (Fig.9)

CAUTION

The adaptor of product must be installed upward. (Fig.9)

The screws for fixing suspension bracket should not be replaced by other screws, otherwise the cord may be damaged and cause fire.

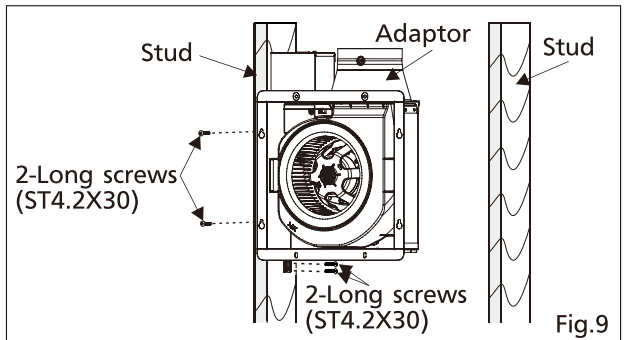
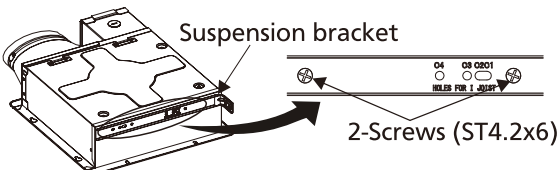

3. Complete the wiring and duct work. (Refer to step 3 to 5 of INSTALLATION I on page 7 - 8).

4. Finish the wall work. Wall hole should be aligned with the inside edge of the flange. (Fig.10)

5. Install the grille. (Refer to step 7 to 11 of INSTALLATION I on page 8 - 9).

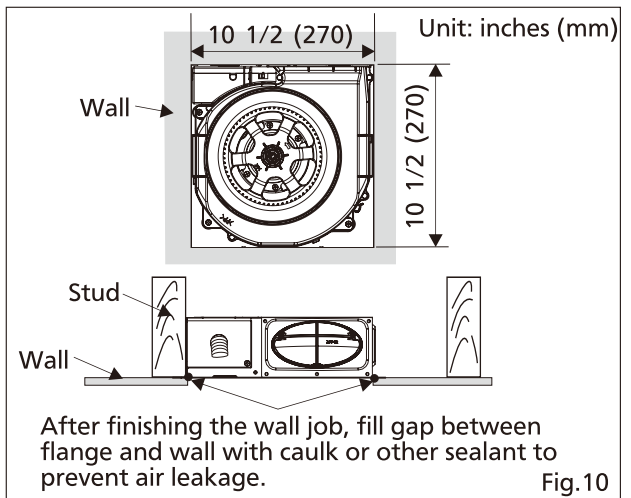

MAINTENANCE (CLEANING)

! WARNING

! Disconnect power source before working on unit.

! CAUTION

- !** Routine maintenance must be done every year. Please wear gloves during the cleaning work.
- ⊘** Never use gasoline, benzene, thinner or any other such chemicals for cleaning the ventilating fan.
- ⊘** Do not immerse motor, LED lamp in water when cleaning. Do not soak resin parts in water over 140 °F (60 °C).

1. Clean grille. (Don't put into water. Use non-abrasive kitchen detergent. Wipe dry with clean cloth.) (Fig.11)
2. Remove one mounting spring from the grille. (Fig.12)
3. Remove the other mounting spring. (Fig.13 ①)
4. Take the LED lamp wire out to remove the grille. (Fig.13 ②)
5. Remove dust and dirt from fan body using a vacuum cleaner. (Fig.14)
6. Using a cloth dampened with kitchen detergent remove any dirt from fan body. Wipe dry with clean cloth. (Fig.14)
7. Reinstall grille.

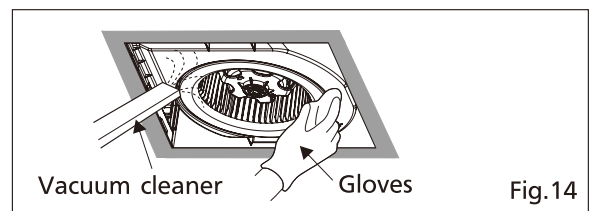
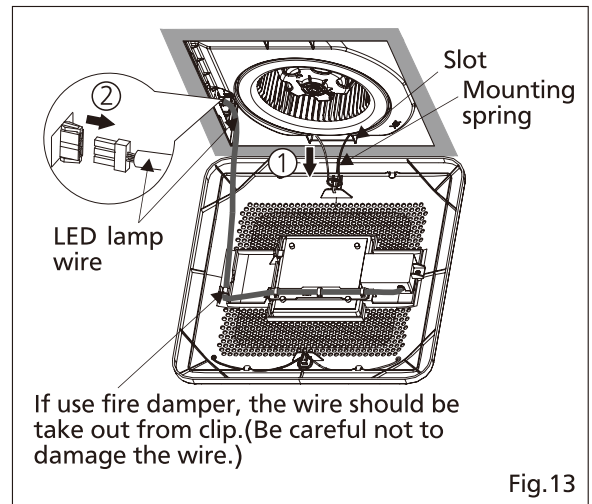
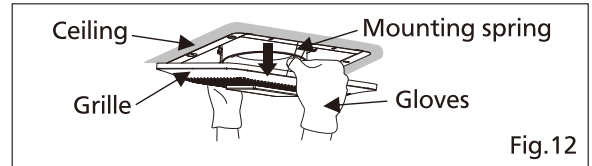
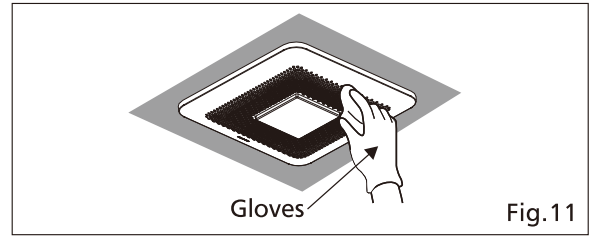

PRACTICAL GUIDE TO INSTALLATION

Properly insulate the area around the fan to minimize building heat loss and gain. (Fig. 15)

Loose fill or batt insulation can be placed directly over the fan housing in the attic. Our fans and fan/light combination units do not create excessive heat that is a common problem with recessed light fixtures or some competitor's fan/light combination. Our efficient, cool-running motors and our LED lighting unit do not create enough ambient heat to be subjected to these limitations.

The ducting from this fan to the outside of the building has a strong effect on the air flow, noise and energy use of the fan. Use the shortest, straightest duct routing possible for best performance, and avoid installing the fan with smaller ducts than recommended. Insulation around the ducts can reduce energy loss and inhibit mold growth. Fans installed with existing ducts may not achieve their rated air flow.

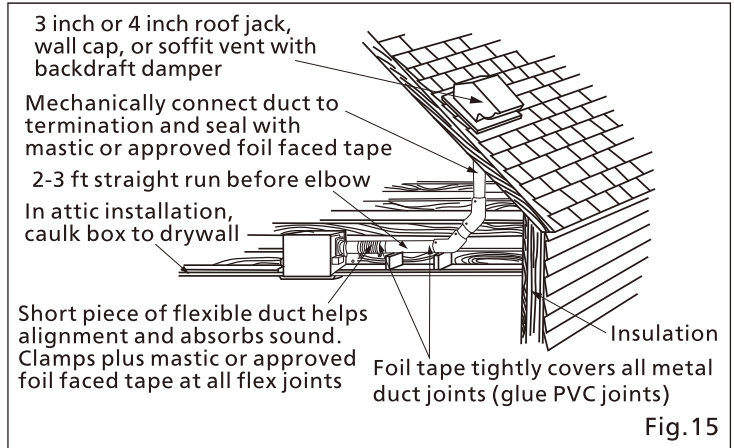

SPECIFICATIONS

Model No.	Air direction	Voltage (V)	Frequency (Hz)	Duct diameter (inches)	Air volume at 0.1" WG (CFM)	Noise (sones)	Speed (rpm)	Power (W)	Weight lb.(kg)
FV-0810RSL1	Exhaust	120	60	4	80	0.5	800	22.1	7.7 (3.5)
					100	1.1	920	27.4	

HVI Certified performance based on HVI Procedures 915, 916 and 920.

PRODUCT SERVICE

Warning Concerning Removal of Covers.

The unit should be serviced by qualified technicians only.

Your product is designed and manufactured to ensure a minimum of maintenance.

Should your unit require service or parts, call Panasonic Call Center at
1-866-292-7299 (USA)

Panasonic Corporation of North America

Two Riverfront Plaza, Newark, NJ 07102

www.panasonic.com