

# FLUIDMASTER® 400ARHRK COMPLETE TOILET REPAIR KIT INSTALLATION INSTRUCTIONS

SCAN HERE!



Before you begin, watch our installation video:  
<http://opn.to/a/400ARHRK>

## TOOLS NEEDED

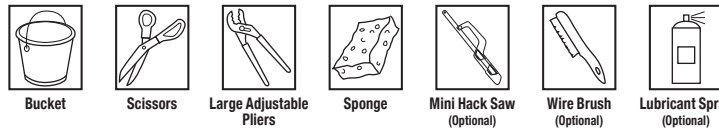

## DON'T USE



**Fluidmaster®**  
30800 Rancho Viejo Road, San Juan Capistrano, CA 92675  
[www.Fluidmaster.com](http://www.Fluidmaster.com) • 800-631-2011  
Contact Fluidmaster for troubleshooting help or visit [www.fluidmaster.com](http://www.fluidmaster.com)  
M-F 5:30 am - 5:00 pm PST.

**WARNING**

**DO NOT USE IN-TANK DROP-IN TOILET BOWL CLEANERS CONTAINING BLEACH OR CHLORINE.** Use of such products will: (1) RESULT IN DAMAGE to tank components and MAY CAUSE FLOODING and PROPERTY DAMAGE and (2) VOID FLUIDMASTER WARRANTY. Fluidmaster Flush 'n Sparkle Toilet Bowl Cleaning System is recommended for those choosing to use in-tank bowl cleaners and WILL NOT VOID the FLUIDMASTER WARRANTY because it will not damage the components. **DO NOT** overtighten nuts or tank/bowl may crack. Always use quality Fluidmaster parts when installing or repairing. Fluidmaster will not be responsible or liable for use of non-Fluidmaster parts during installation or repair.

**LIMITED SEVEN-YEAR EXPRESS WARRANTY**

Subject to the "Exclusions" set forth below, Fluidmaster Inc. promises to the consumer to repair, or at the option of Fluidmaster Inc. to replace any part of this plumbing product which proves to be defective in workmanship or materials under normal use for seven years from the date of purchase. All costs of removal, transportation and reinstallation to obtain warranty service shall be paid by the consumer. During this "Limited Seven Year Express Warranty," Fluidmaster Inc. will provide, subject to the "Exclusions" section set forth below, all replacement parts free of charge, necessary to correct such defects. This "Limited Seven Year Warranty" is null and void if this plumbing product has not been installed and maintained in accordance with all written instructions accompanying the product, and if non-Fluidmaster Inc. parts are used in installation.

**EXCLUSIONS:** FLUIDMASTER INC. SHALL NOT BE LIABLE FOR INCIDENTAL OR CONSEQUENTIAL DAMAGES, INCLUDING COSTS OF INSTALLATION, WATER DAMAGE, PERSONAL INJURY OR FOR ANY DAMAGES RESULTING FROM ABUSE OR MISUSE OF THE PRODUCT, FROM OVERTIGHTENING OR FROM FAILURE TO INSTALL, OR MAINTAIN THIS PLUMBING PRODUCT IN ACCORDANCE WITH THE WRITTEN INSTRUCTIONS, INCLUDING USE OF NON-FLUIDMASTER PARTS. DO NOT USE IN-TANK DROP-IN TOILET BOWL CLEANERS CONTAINING BLEACH OR CHLORINE. USE OF SUCH PRODUCTS WILL RESULT IN DAMAGE TO TANK COMPONENTS AND MAY CAUSE FLOODING AND PROPERTY DAMAGE. USE OF SUCH PRODUCTS WILL VOID THIS WARRANTY.

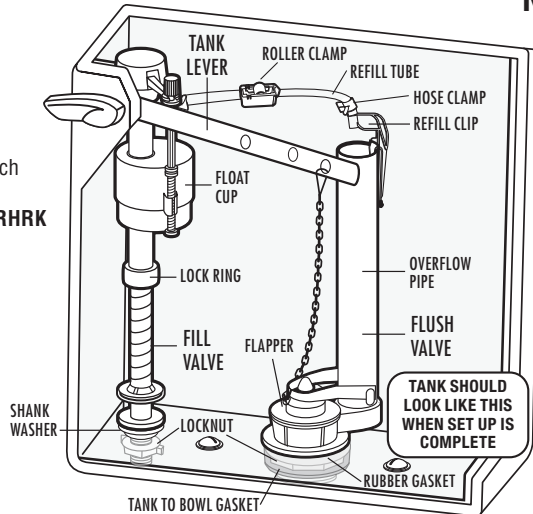

## PARTS IN THIS KIT:

- (1) PerforMAX® Fill Valve
- (1) Shank Washer
- (1) Locknut
- (1) Refill Tube
- (1) Refill Clip
- (1) Roller Clamp
- (2) Hose Clamps
- (1) PerforMAX® Flush Valve with Water Saving Flapper
- (1) Rubber Gasket
- (1) Large Plastic Locknut
- (1) Tank to Bowl Gasket
- (2) Brass Bolts
- (4) Stainless Steel Washers
- (4) Stainless Steel Hex Nuts (two thick & two thin)
- (6) Rubber Washers
- (1) Tank Lever
- (1) Tank Lever Locknut

## PREPARATION

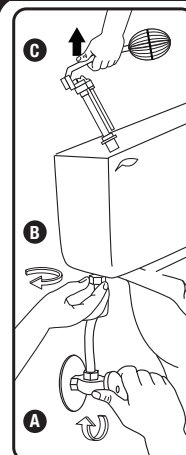

## 1 Remove Old Parts

- Remove tank lid. Use pencil to mark water level of tank. Then follow steps A-G.
- A.** Turn off water supply (Clockwise). Flush toilet and remove excess water from tank with sponge.
  - B.** Remove water supply coupling nut. Remove locknut from under tank.
  - C.** Remove fill valve from tank.
  - D.** Unhook flapper chain from tank lever.
  - E.** Remove tank lever nut (this is a reverse thread nut). Pull lever from tank.
  - F.** Unbolt tank from toilet bowl. Remove tank and lay on its side on a safe and secure surface. Remove washers, nuts and bolts. **NOTE:** If you have a three bolt tank save bolt, washer and nut in best condition for future use. Clean bolt & nut with wire brush and lubricant spray.
  - G.** Remove tank to bowl gasket from under tank. Loosen and remove flush valve locknut and remove flush valve from tank.

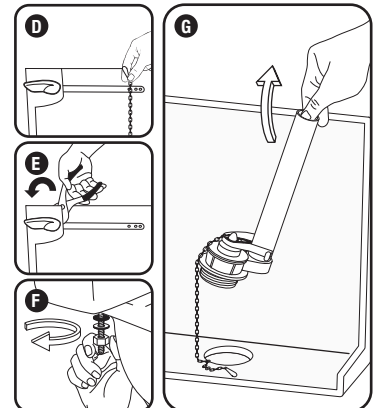

## 2 Preparing the Flush Valve for Installation

Before flush valve installation, ensure overflow pipe and water level of tank are correctly set.

- 1. THE TOP OF OVERFLOW PIPE (A)** must be cut 1" below bottom of **TANK LEVER HOLE (B)**. Remove tank to bowl gasket and flush valve lock nut first. Insert flush valve into tank hole. Mark the flush valve 1" below bottom of tank lever hole. Remove flush valve and cut overflow pipe at specified mark.

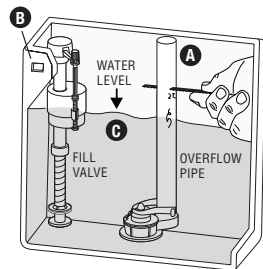

- 2. WATER LEVEL (C)** is set below top of overflow pipe (Fluidmaster recommends 1/2").

Code Compliance helps protect your home & drinking water supply.

## INSTALLATION

## 3 Installing Flush Valve

- A.** Insert flush valve into tank hole. Position overflow pipe toward back of tank (**Do not** cover bolt holes of tank).
- B.** Holding flush valve in place, thread large plastic locknut onto threads of flush valve. Hand tighten locknut and then use large adjustable pliers to go 1/2 turn beyond hand tight. **Do not overtighten.**
- C.** Place tank to bowl gasket on bottom of flush valve locknut. Gasket should cover locknut.

**\*NOTE:** If you have a Gerber or Kohler two piece toilet, it is recommended you use a different tank to bowl gasket.  
**Gerber:** Use an extra thick Gerber gasket.  
**Kohler:** Use a triangular Kohler gasket. (Both Gerber and Kohler gaskets not included).

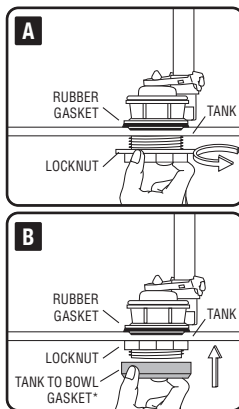

## 4 Installing Toilet Bolts

1. Place one rubber washer on each tank bolt.
2. Place tank bolts through bottom holes of tank.
3. For reinforced connection: Under tank, place metal washers on thin hex nuts and hand tighten to toilet tank. **Caution:** The thin metal hex nut should not touch the toilet bowl porcelain. If touching, stop and remove nuts and washers.
4. Set tank onto bowl. Place rubber washers, metal washers & hex nuts on each bolt under toilet bowl. Using tool, tighten hex nuts evenly until tank is snug and does not rock.

### For Three Bolt Toilets

The kit contains two extra rubber washers for toilets that have three bolts. If you need a third bolt and nut, reuse one of your existing bolt sets along with the new rubber washers supplied.

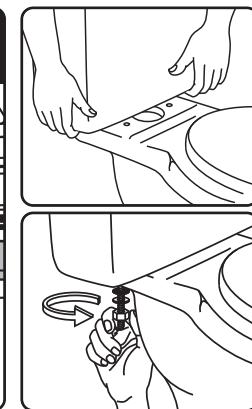
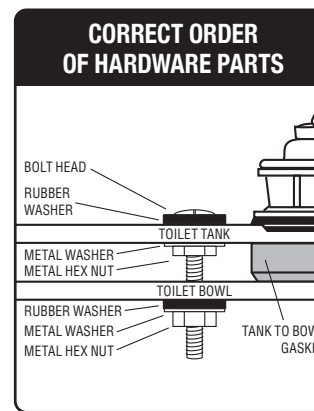

## 5 Preparing the Fill Valve for Installation

- Fill Valve Parts**
- A) Refill Clip
  - B) Refill Tube
  - C) Shank Washer
  - D) Locknut
  - E) Threaded Shank
  - F) Roller Clamp
  - G) Hose Clamps

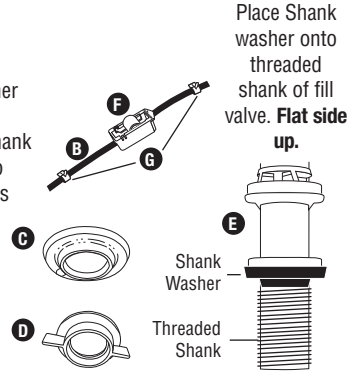

Place Shank washer onto threaded shank of fill valve. **Flat side up.**

## Preparing the Fill Valve for Installation (continued)

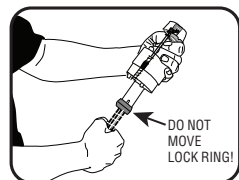
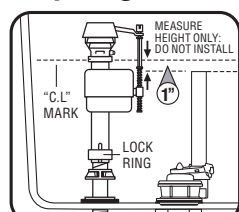

- Fill Valve Positioning:**
- A.** Position fill valve in tank – **DO NOT FULLY INSTALL.**
  - B.** Set top of fill valve 3" above overflow pipe.
- Fill Valve Height Adjustment – If Necessary:**
- A. DO NOT MOVE LOCK RING.**
  - B.** Increase height – twist lower shank counter clockwise.
  - C.** Decrease height – twist lower shank clockwise.
  - D. Critical Level Mark (C.L. Mark) MUST** be positioned 1" above top of overflow pipe – **required by Universal Plumbing Code.**

## 6 Installing New Fill Valve

- A.** Place fill valve in tank.
- B.** Align fill valve nipple to face overflow pipe.
- C.** Press down on shank from inside while tightening locknut.

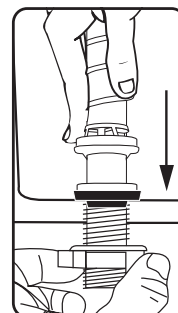

- D. Hand-tighten only – DO NOT OVERTIGHTEN!** Overtightening may crack fill valve or tank causing flooding.
  - E.** Attach one end of refill tube (**b**) to refill clip (**a**).
  - F.** Place clip on right side of overflow pipe.
  - G.** Attach other end of tube to nipple on fill valve – Cut tube as necessary.
  - H.** Squeeze tube clamps and slide to ends of tube and release.
- WARNING:** Placing refill tube down overflow pipe may cause significant water waste.

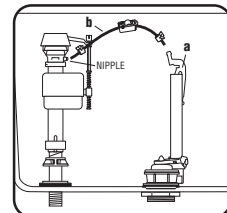

## 7 Installing Lever & Flapper Chain

If the removed tank lever is bent (see picture) proceed to next step. If the lever is not bent then proceed to step **B**. Before installing new tank lever, please remove tank lever lock nut.

- A.** The new lever will need to be bent like the lever that was just removed. To bend lever, start bend 2 inches after 90 degree elbow. **Do not bend arm quickly or back and forth repeatedly.**
- B.** Push lever through tank lever hole. Slide tank lever locknut onto lever arm with flat side of nut facing tank lever thread.
- C.** Tighten locknut in the direction shown (clockwise). **Do Not Over Tighten.** Lock nut is a reverse thread. Attach the clip of the chain to the tank lever directly above the flapper. Leave 1/2 inch of slack in the chain.

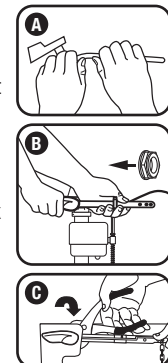

## Adjusting the PerformMAX® High Performance Flapper

- A.** Turn rubber portion of flapper left or right to adjust performance level.
- B.** Clockwise for greater flush volume.
- C.** Counterclockwise for lower flush volume.



## 8 Attach Water Supply Connector

- A.** Attach water supply coupling nut to fill valve – Turn clockwise by hand until tight.
- WARNING:** Over tightening the nut could damage fill valve or coupling nut resulting in flooding and property damage. Fluidmaster Click Seal® Connector is recommended: a perfect seal every time without over tightening.
- B.** To check for leaks, turn on water supply.
  - C.** If leaking occurs – turn coupling nut just enough to stop leaking.
  - D.** Flush toilet to check.
- NOTE:** We recommend replacing the existing water supply connector if it is worn or over 5 years old – this will protect your home from potential flooding and property damage.

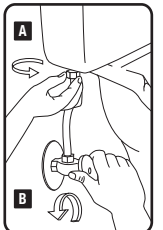

## 9 Adjusting Tank Water Level

- HINT:** When adjusting float cup, flush tank and make adjustment while tank is filling.
- A.** Turn water on.
  - B.** Turn water level adjustment screw to set float cup to desired level.
  - C.** Turning adjustment screw clockwise raises water level.
  - D.** Turning adjustment screw counter clockwise lowers water level.
  - E.** Flush toilet to check new level.

**HINT:** Twisting adjustment screw 8 times moves float by 1/2".

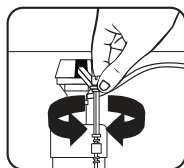

## 10 Water-Saving Feature: Roller Clamp

- HINT:** Flush toilet – if bowl appears full, but continues to fill, valve may be overflowing bowl. Adjust water level as follows:
- A.** Fill bowl with gallon of water & wait for it to recede and stop.
  - B.** Mark water level with pencil and flush toilet. If the water refills above line, water level is too high, if water stops filling below pencil line, water is too low.
  - C.** Adjust water by pushing down and rolling the dial with thumb on roller clamp. "0" means no refill.

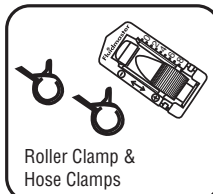

## TROUBLESHOOTING

- IF FILL VALVE DOES NOT TURN ON, WILL NOT TURN OFF, OR WILL NOT REFILL THE TANK AFTER THE FLUSH**
- Remove top cap and check for debris. If you find debris, or flow is weak. Inspect lower section of fill valve for partial blockage. Partial blockage may be at shut off valve or in water supply line (See "REMOVING VALVE CAP & FLUSHING OUT DEBRIS").
  - If fill valve has been in use for some time and/or float cup does not drop when flushing tank, replace seal with a genuine Fluidmaster 242 seal (See "IF REPLACING SEAL").
- IF FILL VALVE TURNS ON AND OFF BY ITSELF, OR IS RUNNING WHEN NO FLUSH HAS TAKEN PLACE**
- This indicates the tank is losing water. The fill valve is refilling lost water. Clean flapper and drain seat. If leak continues change flush valve. Install Fluidmaster 507AKR or 555C kit.
  - Please ensure all steps were followed in "Step 7". Ensure the flapper is clipped in to fall evenly on flush valve seat.
  - Flush valve locknut may not be tight enough. Check locknut and use tools to ensure locknut is tightened 1/2 turn past hand tight.
- IF WATER LEVEL IN BOWL IS TOO LOW**
- Make sure the refill tube is supplying water down overflow pipe.
  - Water level in tank may be too low. Raise water level to 1/2" below top of overflow pipe (See "Step 9"). You may have to lengthen the fill valve in order to increase the water level in tank (See "Step 5").
  - Flapper may be closing too soon. Give flapper chain approximately 1/2" of slack (See "Step 7").
- LEAKING AT BOLTS AND/OR ON BASE OF TOILET**
- Bolts are likely not tight enough or a step was missed in "See Step 4". Please ensure all steps were followed. Tighten bolts further until tank does not rock and leak stops.
- LEAK OCCURS WHEN TOILET IS FLUSHED**
- This usually means that tank to bowl gasket is not centered and seated properly. Please ensure all steps were followed in "Step 3". Confirm the flush valve locknut is tightened. Tank to bowl gasket needs to fully cover locknut.
  - **NOTE:** If you have a Gerber or Kohler two piece toilet, it is recommended you use a different tank to bowl gasket. **Gerber:** Use an extra thick Gerber gasket. **Kohler:** Use a triangular Kohler gasket. (Both Gerber and Kohler gaskets not included).

## Removing Valve Cap, Flushing Out Debris, Replacing Seal, & Replacing Valve Cap

**Removing Valve Cap Assembly**

Turn off water supply & flush out tank. Push float up with right hand (see picture). Grip and hold shaft under float with right hand. With left hand, twist cap and lever counter clockwise 1/8th of a turn to unlock the top cap. Pressing down on top may be helpful with older valves. Let cap assembly hang on float cup.



**Flushing Out Debris**

Hold cup upside down over uncapped valve to prevent splashing. Turn water supply on and off a few times. Turn water supply off when putting cap back on valve.



- If Replacing Seal**
- Use only a genuine Fluidmaster 242 seal.
- Replacing Valve Cap**
- A.** Place cap assembly on top of gray valve body by aligning cap arm and adjustment rod next to refill tube.
  - B.** Press down on top cap while rotating top & arm clockwise to locked position.

