

Kit Contents

Check the contents of the box with these instructions to verify all parts are present. This will allow you to become familiar with the components of your new handrail.

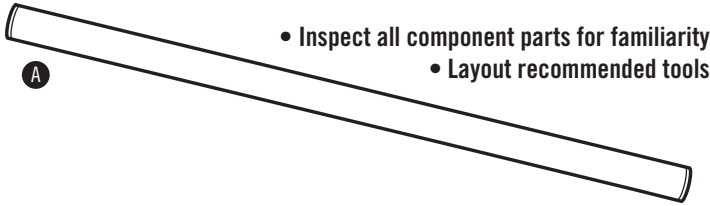

QTY. PART

A. (1) Round Handrail

(All components shown in these instructions are sold separately) Call 800.248.1520 with questions on purchasing additional components.

Required Tools for Handrail Installation

(not included)

1- Screw or Impact Gun

2- Tape Measure

3- Drill Bits: 1/4" wood/5/32" metal/wood
1/2" & 5/16"

4- Hex Bit Driver

5- Pencil

6- Masking Tape (or painters tape)

7- Safety Glasses

8- Rubber Mallet

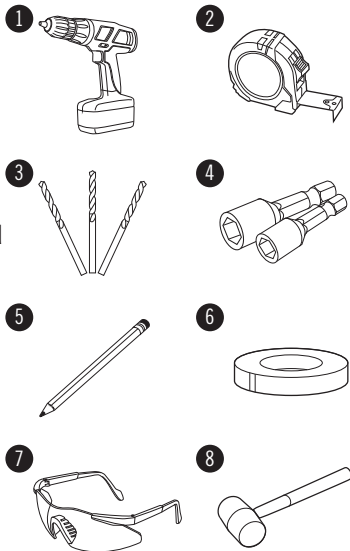

Care and Maintenance

Gently wash with a clean, soft cloth and a mild detergent (e.g. Dawn Liquid Dish Soap) followed by a clean water rinse and dry with a clean towel.

Even though powder coatings are highly resistant, certain solvents can harm them. Avoid contact with all harsh chemicals and salts. If any of these should contact the powder coated surface, immediately wipe the area with a soft, clean cloth, and wash as described above.

THANK YOU FOR YOUR BUSINESS!

For questions or comments contact Madden Industries:
573.552.6590

STRAIGHT ADA HANDRAIL INSTRUCTIONS

BUILDING STYLE & SAFETY FOR YOUR LIFE



Congratulations!

You are on your way to a maintenance free handrail system that is easily assembled and installed.

Please take a moment to read the instructions before you begin assembling your handrail.

Contents

Handrail Wall Installation	Inside
Kit Contents	BC
Required Tools (not included)	BC
Care and Maintenance	BC

Handrail Step-by-Step Installation

Note: Check local code requirements prior to installation

This handrail's versatility allows for many different types of installations. Therefore, these suggested steps may vary for your application. Please note, you may install your handrail onto many different wall types simply by obtaining the appropriate fasteners. If you have any questions on recommended fasteners, please visit our website. www.maddenmetals.com

Handrail Interior Wall Installation

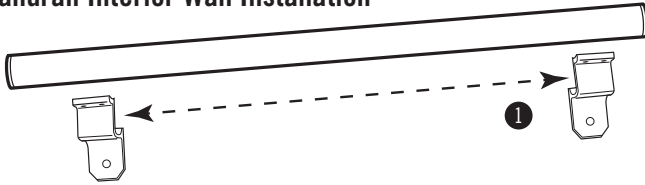

1. On the ground, layout handrail and wall brackets to ensure you will achieve your desired look and symmetry once the handrail is installed.

2. Determine approximate handrail installation location.

3. Determine stud or secure mounting location for the wall brackets. For a safe installation, handrail brackets must be anchored securely to the wood framing behind the drywall or plaster of an interior wall.

4. Using a pencil or masking tape mark the center of stud locations along the wall. (If unsure on how to locate a wall stud, there are many references on the Internet).

5. At this point the handrail may be cut to your desired length using a 60-80 tooth wood blade and chop saw. Metal cutting blades **ARE NOT** recommended as they will melt the aluminum.

6. Install endcaps into the handrail using a hammer and a protective barrier to protect the caps's finish (i.e. cardboard from package) **IMPORTANT!! THE ENDCAP MUST BE INSERTED EVENLY INTO HANDRAIL, SHAVING OFF EXCESS PAINT MAY HELP.**

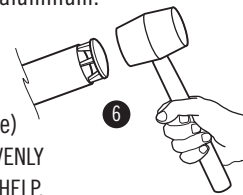

7. Starting at the low end of handrail, measure from the nose of your stair tread up the wall 33". Holding the wall bracket in place, make a pencil mark where the wall bracket fastener is to be installed into the stud (in the large bracket fastener hole).

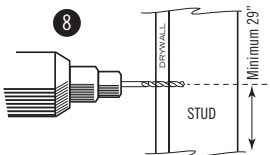

8. When using the provided wood lag screw, drill a 1/4" pilot hole into the wall and CENTER OF STUD for the wall bracket fastener. Important: Ensure your pilot hole is hitting a solid mounting surface – i.e. the center of a stud.

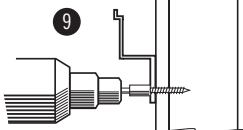

9. Loosely secure the wall bracket to the wall with the appropriate included fastener.

10. Now repeat steps 5-7 for the upper wall bracket.

11. Set the handrail on the wall brackets and mark pilot hole locations for the lower bracket to attach to the handrail.

Tip: Use the drill (with bit spinning) to make your pilot hole mark

12. Place handrail on a gentle surface (ie. carpet) and drill 5/32" pilot holes for the lower bracket only.

13. Loosely fasten handrail to the lower wall bracket with provided fasteners and proceed to mark pilot hole locations for upper bracket.

14. Complete final assembly by attaching wall brackets to the handrail and then tighten brackets to the wall.

15. Apply bolt caps over bolt heads. We highly recommend using a small amount of Super Glue or caulk inside the bolt cap to firmly secure the bolt cap to the bolt head.

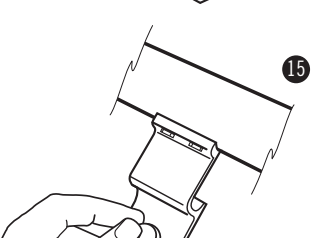
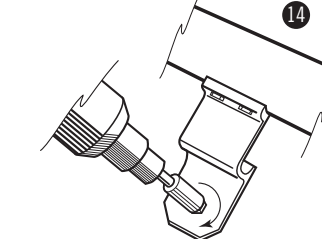
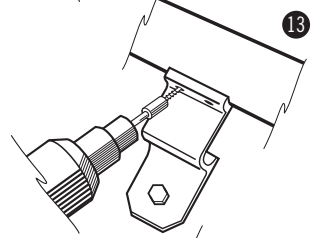
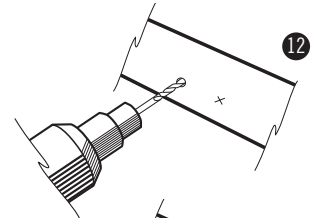
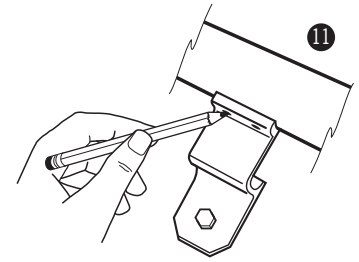

Installation complete!

Note: Additional fasteners may be piloted and fastened into the wall brackets for additional support.

