

INSTALLATION

Installation Overview

Please read the following installation instructions first after purchasing this product or transporting it to another location.

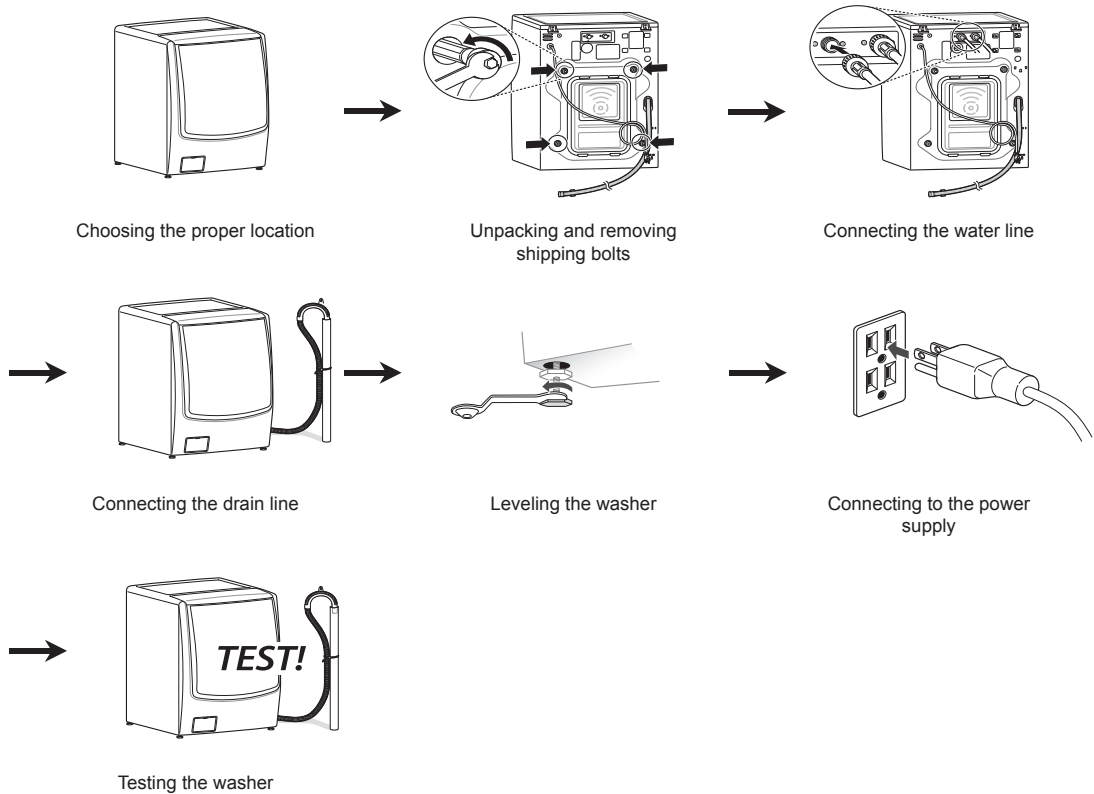

Choosing the proper location

Unpacking and removing shipping bolts

Connecting the water line

Connecting the drain line

Leveling the washer

Connecting to the power supply

Testing the washer

⚠ WARNING

- Moving or installation of the appliance requires two or more people. Failure to follow these instructions may result in injury.
- Store and install the appliance where it will not be exposed to temperatures below freezing or exposed to outdoor weather conditions. Failure to follow this warning can cause product or part failure, serious injury, fire, electric shock, or death.
- Properly ground the washer to conform with all governing codes and ordinances. Failure to follow this warning can cause serious injury, fire, electric shock, or death.
- To reduce the risk of electric shock, do not install the appliance in humid spaces. Failure to follow this warning can cause serious injury, fire, electric shock, or death.
- To ensure proper air flow, do not block the large opening on the bottom of the washer with carpeting or other materials.
- Do not remove the ground prong. Do not use an adapter or extension cord. Plug into a grounded 3-prong outlet. Failure to follow this warning can cause serious injury, fire, electric shock, or death.

Product Specifications

The appearance and specifications listed in this manual may vary due to constant product improvements.

Model WM9500H*A	
Electrical requirements	120 VAC @ 60 Hz
Min. / Max. water pressure	20 – 120 psi (138–827 kPa)
Dimensions	75.2 cm (W) X 86.4 cm (D) X 104.5 (H), 143 cm (D with door open) 29 5/8" (W) X 34 1/16" (D) X 41 3/16" (H), 56 5/16" (D with door open)
Net weight	239 lb (108kg)
Max spin speed	1300 RPM

Tools Required for Installation

- Adjustable Pliers

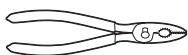

- Carpenter's Level



Choosing the Proper Location

Install the washer on a solid floor that is strong and rigid enough to support the weight of the washer, even when fully loaded, without flexing or bouncing. If the floor has too much flex, you may need to reinforce it to make it more rigid. If the floor is not solid, it may cause severe vibration and noise.

NOTE

- Before installing the washer, make sure the floor is clean, dry and free of dust, dirt, water and oil so the washer feet cannot slide easily. Leveling feet that can move or slide on the floor can contribute to excess vibration and noise due to poor contact with the floor.
- If a drip pan must be used, take extra care to follow the instructions provided with the drip pan and make sure the leveling feet are adjusted for firm and even contact with the pan. Use of drip pans and failure to properly level the machine may result in increased vibration and noise during operation.
- Allow for sufficient space between the walls and the washer for installation.

Power Outlet

- The power outlet must be within 60 inches (1.5 m) of either side of the washer.
- The appliance and outlet must be positioned so that the plug is easily accessible.
- Do not overload the outlet with more than one appliance.
- The outlet must be grounded in accordance with current wiring electric codes and regulations.
- Use a time-delay fuse or circuit breaker.

NOTE

- It is the personal responsibility and obligation of the product owner to have a proper outlet installed by qualified service personnel.

Flooring

- To minimize noise and vibration, the washer must be installed on a solidly constructed floor.
- Allowable slope under the entire washer is a maximum 1 inches difference from side to side or from front to back.
- Installing on carpeting and soft tile surfaces is not recommended.

- Never install the washer on a platform or weakly supported structure.

NOTE

- The washer must be installed on firm flooring to minimize vibration during the spin cycle. Concrete flooring is best, but a wood floor is sufficient, provided it is built to FHA standards.

Floor Installation

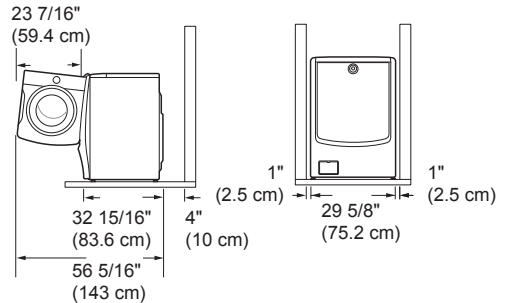

To ensure sufficient clearance for water lines, the drain line and airflow, allow minimum clearances of at least 1 inches (2.5 cm) at the sides and 4 inches (10 cm) behind the unit. Be sure to allow for wall, door, or floor moldings that may increase the required clearances.

NOTE

- Do not use a drip pan as it can block the drawer. Using the drip pan may result in increased vibration and noise during operation.

Pedestal Washer Installation

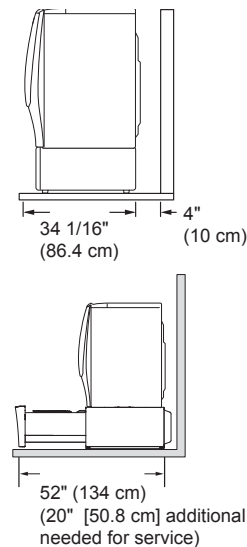

NOTE

- Refer to the instructions packaged with the optional pedestal kit before installing with a pedestal kit.

Unpacking and Removing Shipping Bolts

1 Lift the washer off the foam base.

After removing the carton and shipping material, lift the washer off the foam base. Make sure the plastic tub support comes off with the base and is not stuck to the bottom of the washer.

If you must lay the washer down to remove the base packaging materials, always protect the side of the washer and lay it carefully on its side. Do not lay the washer on its front or back.

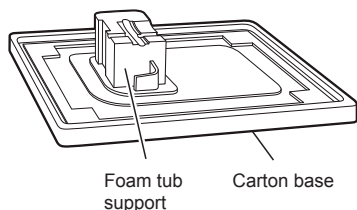

2 Remove the bolt assemblies.

Starting with the bottom two shipping bolts, use the wrench (included) to fully loosen all four shipping bolts by turning them counterclockwise. Remove the bolt assemblies by wiggling them slightly while pulling them out.

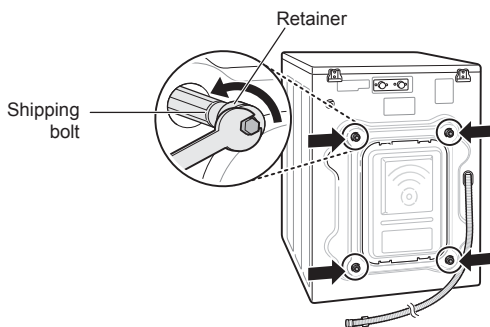

3 Install the hole caps.

Locate the four hole caps included in the accessory pack and install them in the shipping bolt holes.

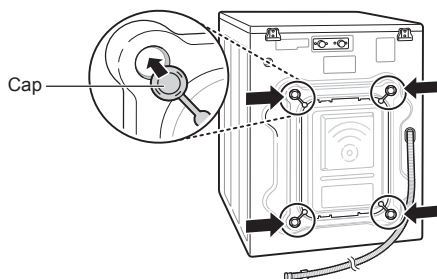

NOTE

- Save the bolt assemblies for future use. To prevent damage to internal components, do not transport the washer without reinstalling the shipping bolts.
- Failure to remove shipping bolts and retainers may cause severe vibration and noise, which can lead to permanent damage to the washer. The cord is secured to the back of the washer with a shipping bolt to help prevent operation with shipping bolts in place.

Connecting the Water Lines

1 Check the fittings and seals.

Inspect the threaded fitting on each hose and make sure there is a rubber seal in place in both ends of each hose to prevent leaking.

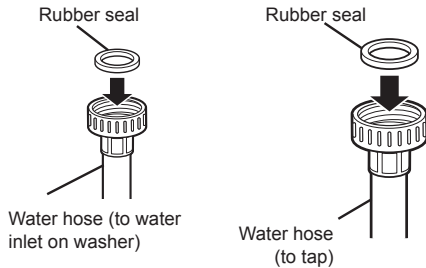

2 Connect the water supply hoses.

Connect the water supply hoses to the hot and cold water faucets tightly by hand and then tighten another 2/3 turn with pliers. Connect the blue hose to a cold water faucet and the red hose to a hot water faucet.

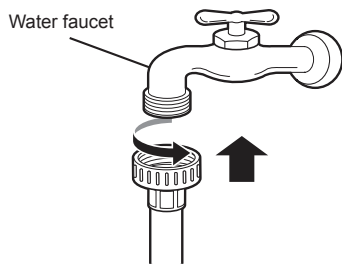

3 Flush out the inlet hoses.

After connecting the inlet hoses to the water faucets, turn on the water faucets to flush out foreign substances (dirt, sand or sawdust) in the water lines. Let water drain into a bucket, and check the water temperature to make sure you've connected the hoses to the correct faucets.

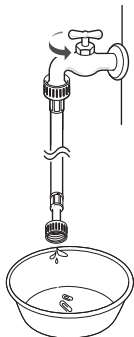

4 Attach the water lines to the back of the washer.

Attach the hot water line to the hot water inlet on the back of the washer. Attach the cold water line to the cold water inlet on the back of the washer. Tighten the fittings securely. Turn ON both faucets all the way and check for leaks at both ends of the hoses.

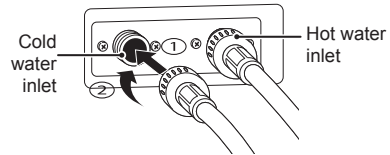

! WARNING

- Do not overtighten the hoses or crossthread the hose fittings. Overtightening or cross-threading can damage the valves, resulting in leaking and property damage.
- Do not overtighten. Damage to the coupling can result.

! CAUTION

- Do not reuse old hoses. Use only new hoses when installing the washer. Old hoses could leak or burst causing flooding and property damage. Contact LG Customer Service for assistance in buying hoses: 1-800-984-6306.

NOTE

- Periodically check the hoses for cracks, leaks, and wear, and replace the hoses every five years. Do not stretch the water hoses intentionally, and make sure that they are not pinched, crushed or kinked by other objects.
- Water supply pressure must be between 20 psi and 120 psi (138 – 827 kPa). If the water supply pressure is more than 120 psi, a pressure reducing valve must be installed.
- To provide optimum washing performance, the hot water temperature should be set at 120 – 135 °F (48 – 57 °C) and the cold at 60 °F (15 °C).
- The washer should never be installed or stored in a location subject to freezing temperatures. Damage to the water lines and internal mechanisms of the washer can result. If the washer was exposed to freezing temperatures prior to installation, allow it to stand at room temperature for several hours before use and check for leaks prior to operation.

Connecting the Drain Hose

NOTE

- The drain hose should always be properly secured. Failure to properly secure the drain hose can result in flooding and property damage.
- The drain must be installed in accordance with any applicable local codes and regulations.
- Make sure that the drain hose is not stretched, pinched, crushed, or kinked.
- Do not install the drain hose with the end lower than 29.5 inches (0.7 m) or higher than 96 inches (2.4 m) above the bottom of the washer or more than 60 inches (1.5 m) away from the washer.
- Never create an airtight seal between the hose and the drain with tape or other means. If no air gap is present, water can be siphoned out of the tub resulting in poor wash/rinse performance or clothing damage.

Option 1: Standpipe

1 Clip the end of the hose into the elbow bracket.

Connect the elbow bracket within 4 inches (10 cm) of the end of the drain hose. If the drain hose is extended more than 4 inches (10 cm) beyond the end of the elbow bracket, mold or microorganisms could spread to the inside of the washer.

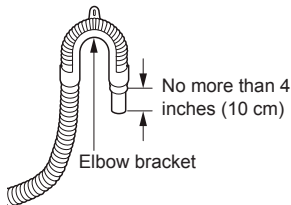

2 Insert the end of the drain hose into the standpipe.

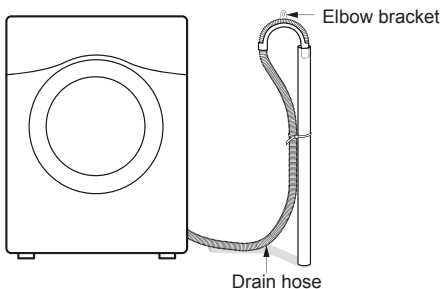

3 Use a tie strap to secure the drain hose in place.

Option 2: Laundry Tub

1 Clip the end of the hose into the elbow bracket.

Connect the elbow bracket within 4 inches (10 cm) of the end of the drain hose. If the drain hose is extended more than 4 inches (10 cm) beyond the end of the elbow bracket, mold or microorganisms could spread to the inside of the washer.

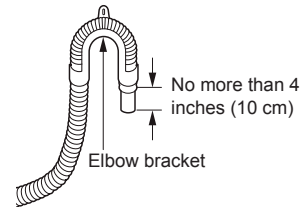

2 Hang the end of the drain hose over the side of the laundry tub.

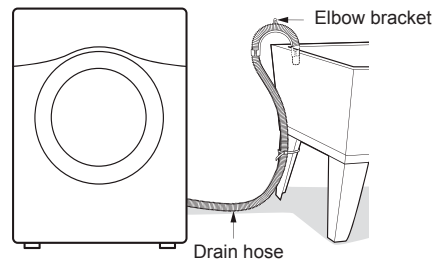

3 Use a tie strap to secure the drain hose in place.

Leveling the Washer

The drum of your new washer spins at very high speeds. To minimize vibration, noise, and unwanted movement, the floor must be a level, solid surface. The slope beneath the washer should not exceed 1 inch, and all four leveling feet must rest firmly on the floor.

NOTE

- Adjust the leveling feet only as far as necessary to level the washer. Extending the leveling feet more than necessary can cause the washer to vibrate
- Before installing the washer, make sure that the floor is clean, dry and free of dust, dirt, water and oil so the washer feet cannot slide easily. Feet that move or slide on the floor can contribute to excessive vibration and noise due to poor contact with the floor.

1 Position the washer in its final location.

Take special care not to pinch, strain, or crush the water and drain lines. If you have a carpenter's level, you can place it across the top of the washer.

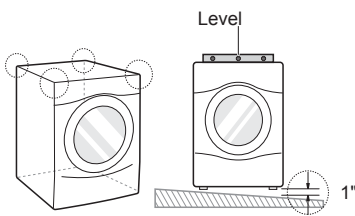

2 Adjust the lower leveling feet.

Turn in one direction to raise the washer or the other direction to lower it.

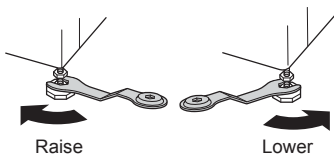

3 Tighten the locknuts.

Turn the locknuts counterclockwise and tighten them when the washer is level.

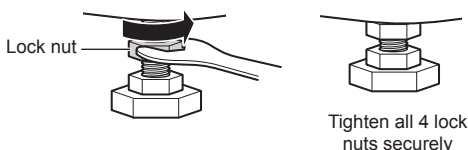

4 Recheck the washer's levelness.

Push or rock the top edges of the washer gently to make sure the washer does not rock. If the washer rocks, repeat steps 1-3.

CAUTION

- Using the washer without leveling it may cause excess vibration and noise, leading to a machine malfunction.
- Extend the leveling feet only to level the washer. If you extend the leveling feet unnecessarily, it may cause abnormal vibration of the washer.

Using Non-Skid Pads

If you install the washer on a slippery surface, it may move because of excessive vibration. Incorrect leveling may cause malfunction through noise and vibration. If this occurs, install the non-skid pads under the leveling feet and adjust the level.

1 Clean the floor to attach the non-skid pads.

Use a dry rag to remove and clean foreign objects or moisture. If moisture remains, the non-skid pads may slip.

2 Adjust the level after placing the washer in the installation area.

3 Place the adhesive side of the non-skid pad on the floor.

It is most effective to install the non-skid pads under the front legs. If it is hard to place the pads under the front legs, place them under the back legs.

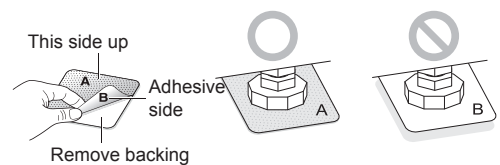

4 Recheck the washer's levelness.

Push or rock the top edges of the washer gently to make sure that the washer does not rock. If the washer rocks, level the washer again.

Connecting to the Power Supply

The washer should be plugged into a 120-VAC, 60 Hz grounded 3-prong outlet. Plug in the washer.

! WARNING

- Do not use a worn or damaged power cord or power plug. Replace or repair it immediately. Failure to do so may result in death, fire, electric shock, or malfunction.
- Do not modify the power cord and plug provided with the appliance. Take care not to damage it when installing or moving the washer. Failure to do so may result in death, fire, electric shock, or malfunction.
- Make sure that the washer is grounded.
- Connect this washer to a grounded outlet conforming to the rating prior to use. Failure to do so may result in fire, electric shock, or malfunction.
- Do not damage or cut off the ground prong of the power cord. Doing so may cause death, fire, electric shock, or product malfunction.
- Improper connection of the equipment-grounding conductor can result in risk of electric shock. Check with a qualified electrician or service technician if you are in doubt as to whether the appliance is properly grounded. If it does not fit the outlet, have a proper outlet installed by a qualified electrician
- The appliance and outlet must be positioned so that the plug is easily accessible.
- Do not use adapters or extension cords. Doing so may result in serious injury, fire, electric shock, or death.
- For best performance, plug the washer into its own individual outlet. This helps prevent overloading house wiring circuits which could cause a fire hazard from overheated wires.
- If necessary, use a new, UL-listed 3-prong adapter or 3-wire extension cord with a 3-prong (grounding) plug rated at no less than the branch circuit. Do not use an extension cord longer than 3 feet. Failure to follow these warnings may result in serious injury, fire, electric shock, or death.

Testing the Washer

Check if the washer is properly installed and run a test cycle.

- 1** Load the washer with 6 pounds of laundry (approximately 6 thick bath towels).
- 2** Press the **Power** button.
- 3** Select the **Rinse+Spin**.
- 4** Press the **Start/Pause** button.
The wash cycle starts.
- 5** Check if water is supplied, that the machine does not rock or vibrate excessively, and that it drains well during the spin cycle.

NOTE

- If water leaks during water supply, see Connect the Water Lines to connect them properly.
- If the washer rocks and vibrates excessively, see Level the Washer to level it again.
- If the drain does not work, see Connect the Drain Hose to install the hose properly.

! CAUTION

- Be careful not to catch hands when opening or closing the door.

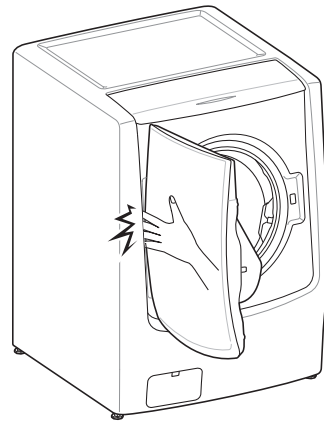

OPERATION

Using the Washer

WARNING

- To reduce the risk of fire, electric shock, or injury to persons, read the SAFETY INSTRUCTIONS before operating this appliance.

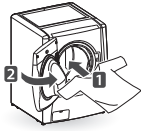

1 Sort Laundry and Load the Washer

Sort laundry by fabric type, soil level, color and load size, as needed. Open the door and load items into the washer.

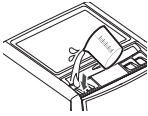

2 Cleaning Products

Add the proper amount of HE (High-Efficiency) detergent to the detergent dispenser. If desired, add bleach or fabric softener to the appropriate dispensers.



3 Turn on the Washer

Press the **Power** button to turn on the washer. The lights above the cycle buttons will illuminate and a chime will sound.



4 Cycle Buttons

Press the Cycle button until the desired cycle is selected.



5 Adjust Settings

Default settings for the selected cycle can now be changed, if desired, using the cycle modifier and option buttons.

NOTE

- Not all modifiers and options are available on all cycles. A different chime will sound and the LED will not come on if the selection is not allowed.



6 Begin Cycle

Press the **Start/Pause** button to begin the cycle. The washer will agitate briefly without water to measure the weight of the load. If the **Start/Pause** button is not pressed within 60 minutes, the washer will shut off and all settings will be lost.



7 End of Cycle

When the cycle is finished, a melody will sound. Immediately remove your clothing from the washer to reduce wrinkling. Check around the door seal when removing the load for small items that may be caught in the seal.

NOTE

- The washer rotates the laundry in a way that allows it to use less water while still fully saturating your clothing. It is normal to not be able to see water during the wash cycle. If the temperature or the water level inside the machine is too high, the door locks and cannot be opened. To open the door while washing, use the Rinse+Spin feature.

Sorting Laundry

CAUTION

- The washer can be fully loaded, but the drum should not be tightly packed with items. The door of the washer should close easily.
- Use the Jumbo Wash/Bedding cycle for buoyant or nonabsorbent items such as pillows or comforters. Failure to follow this caution can result in leakage.
- If possible, do not wash any water-resistant items. If you must, please select the Jumbo Wash/Bedding cycle.

Grouping Similar Items

For the best washing results, and to reduce the possibility of damage to clothing, care should be taken to sort the clothing into loads that are made up of similar items.

Mixing different fabric types and/or soil levels can result in poor wash performance, color transfer, discoloration, fabric damage or linting. Fabrics should be sorted into groups as described below.

Colors

Sort articles by color. Wash dark clothes together in a separate load from light colors or whites. Mixing dark clothes with light clothes can result in dye transfer or discoloration of the lighter clothes.

Soil Level

Wash heavily soiled clothing together. Washing lightly soiled clothing in the same load with heavily soiled clothing could result in poor wash performance for the lightly soiled clothing.

Fabric Type

Delicate articles should not be mixed with heavy or sturdy fabric types. Washing heavy fabrics in a delicate load can result in poor wash performance for the heavy fabrics and possible damage to the delicates.

Lint Type









Some fabrics attract and bind lint to them while others give off lint in the laundry process. Avoid mixing these lint collectors and lint producers in the same load. Mixing these fabrics will result in pilling and linting on the lint collectors. (For example, lint collector—knit sweater; lint producer—terry cloth towels.)

Sort Laundry

By colors	By Soil	By Fabric	By Lint
White	Heavy	Delicates	Lint Producer
Lights	Normal	Easy Care	Lint Collector
Darks	Light	Sturdy	

Fabric Care Labels

Many articles of clothing include a fabric care label. Using the chart below, adjust the cycle and option selections to care for your clothing according to the manufacturer's recommendations.

Category	Label	Directions
Washing		Hand wash
		Machine wash, Normal cycle
		Perm Press/Wrinkle Resistant setting (which has a cool down or cold spray before the slower spin)
		Gentle/Delicate setting (slow agitation and/or reduced wash time)
		Do not wash
		Do not wring
Water Temperature	...	Hot
	..	Warm
	.	Cold/Cool
Bleach Symbols		Any bleach (when needed)
		Only non-chlorine bleach (when needed)
		Do not bleach

Loading the Washer

- Check and empty pockets. Paper clips, coins, matches, etc. can damage clothing and the washer.
- Close zippers and hooks, and tie drawstrings to prevent snagging or tangling of clothes.
- Pretreat heavily stained areas for best results.
- Combine large and small items in a load. Load large items first. Large items should not be more than half of total load.
- The washer can be fully loaded, but the drum should not be tightly packed with items. The door of the washer must close easily.
- Do not wash single small items. Add 1-2 similar items to the load to prevent an out-of-balance load.
- Wash thick, bulky items individually. Heavy blankets, comforters, bedspreads, or pet beds can get tangled or cause an unbalanced load if combined with other items.
- Do not wash/spin waterproof items. Washing raincoats or sleeping bags may result in abnormal vibration or may cause the load to bounce, which could damage the drum.
- Wash small, light items in a mesh bag. Items like underwear can get caught in the door seal, and a brassiere hook may damage other items or the drum.
- Brush off heavy soil, dust, and hair from items before washing. Excess dirt or sand can abrade other fabrics and lead to poor wash performance.
- For best performance, load clothes as shown.

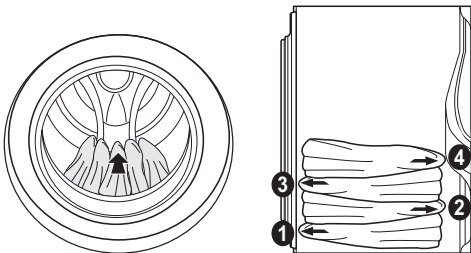

- Load clothes loosely, and do not overfill the drum. Clothes need room to circulate in order to get clean.
- Do not press down on items while stacking them in the drum.

Adding Cleaning Products

Loading the Dispenser

To add detergent, bleach, and fabric softener to the automatic dispenser.

1 Open the dispenser lid.

- Push the front handle to slide the lid open.

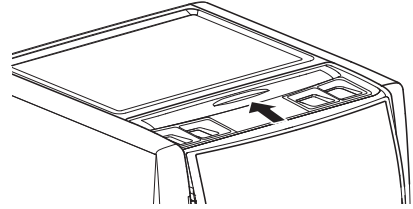

2 Load the laundry products into the appropriate compartments.

- If using a liquid detergent, make sure the liquid detergent cup is in place.
- If using a powdered detergent, remove the liquid detergent cup and put the powder in the main wash detergent compartment.

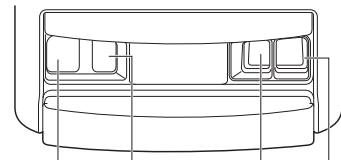

Main wash detergent compartment Pre-wash detergent compartment Liquid chlorine bleach compartment Liquid fabric softener compartment

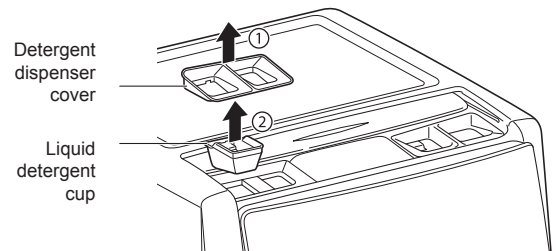

3 Close the lid completely before starting the cycle.

- Be careful not to catch a hand in the lid while closing.

NOTE

- It is normal for a small amount of water to remain in the dispenser compartments at the end of the cycle.

IMPORTANT:

- Do not place or store laundry products, such as detergent, bleach, or liquid fabric softener, on top of your washer or dryer. Wipe up any spills immediately. These products can damage the machine's finish and controls.

CAUTION

- To avoid injury, do not place fingers under the lid or between the lid and the cabinet when pressing or sliding the detergent dispenser lid open or closed.

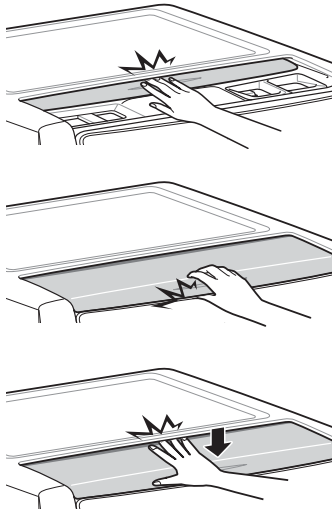
**Pre-Wash Detergent Compartment**

Add liquid or powdered detergent to this compartment when using the Pre-Wash option. Always use HE (High-Efficiency) detergent with your washer.

- When using the Pre-Wash option, liquid detergent for the main wash needs to be loaded in the liquid detergent cup accessory in the main wash dispenser, to prevent it from being dispensed with the pre-wash detergent.
- The amount of detergent added for the Pre-Wash option is 1/2 the amount recommended for the main wash cycle. For example, if the main wash cycle requires one measure of detergent, add 1/2 measure for the Pre-Wash option.

Main Wash Detergent Compartment

This compartment holds laundry detergent for the main wash cycle. Either powdered or liquid detergent may be used in this compartment. The detergent is added to the load at the beginning of the cycle. Always use HE (High-Efficiency) detergent with your washer.

NOTE

- Never exceed the manufacturer's recommendations when adding detergent. Using too much detergent can result in detergent buildup in clothing and the washer.
- Liquid or powdered color-safe bleach may be added to the main wash compartment with detergent of the same type.
- When using liquid detergent, make sure the liquid detergent cup and insert are in place. Do not exceed the maximum fill line.
- When using powdered detergent, remove the insert and liquid detergent cup from the compartment. Powdered detergent will not dispense with the liquid detergent cup and insert in place.
- If you use a detergent that does not dissolve easily or a detergent with high viscosity, it will leave a residue and clog on the dispenser.

Liquid Bleach Compartment

This compartment holds liquid bleach, which is dispensed automatically at the proper time during the wash cycle. The dispenser is activated twice to ensure complete dispensing of the bleach. Any liquid remaining in the dispenser at the end of the cycle is water, not bleach.

- Do not add powdered bleach to this compartment. The bleach compartment is designed to dispense liquid bleach only. Powdered or liquid color-safe bleach will not dispense properly.
- Always follow the manufacturer's recommendations when adding bleach. Never add more than one cup and do not exceed the maximum fill line since this can cause the bleach to be dispensed immediately, resulting in damage to fabrics. Using too much bleach can damage fabrics.
- Never pour undiluted liquid chlorine bleach directly onto the load or into the drum. Fabric damage can occur.
- Do not use color-safe bleach or Oxi products in the same cycle with liquid chlorine bleach.

WARNING

- Do NOT mix chlorine bleach with ammonia or acids such as vinegar or rust/scale remover. Mixing chemicals like these can produce a lethal gas, resulting in severe injury or death.

Fabric Softener Compartment

This compartment holds liquid fabric softener, which is automatically dispensed during the final rinse cycle. Do not exceed the manufacturer's recommendations when adding softener. Using too much fabric softener can result in buildup in clothing and the washer. Either powdered or liquid fabric softener may be used.

- Follow the manufacturer's recommendations when adding fabric softener. Do not exceed the maximum fill line. Using too much fabric softener may stain clothes.
- Dilute concentrated fabric softeners with warm water. Do not exceed the maximum fill line.
- Never pour fabric softener directly onto the load or into the drum.

Detergent Use

This washer is designed for use with only HE (High-Efficiency) detergents. HE detergents produce fewer suds, dissolve more efficiently to improve washing and rinsing performance, and help to keep the interior of the washer clean. Using detergent that is not HE may cause oversudsing and unsatisfactory performance which could result in error codes, cycle failure, and machine damage.



Designed specially to use only HE (High-Efficiency) detergent

- For proper wash performance, always measure detergent using the measuring device provided by the detergent manufacturer. For an average load, use less than half of the recommended maximum. Use less detergent for soft water, light soil, or smaller loads.
- Never use more than the maximum amount of detergent recommended by the manufacturer. Using too much detergent can lead to oversudsing, poor rinsing, detergent buildup in clothing, and residue buildup that can contribute to odors in the machine.
- Use extra care when measuring 2X and 3X concentrated detergents because even a small amount extra can lead to problems.
- Detergents designated as HE-compatible may not provide optimal results.

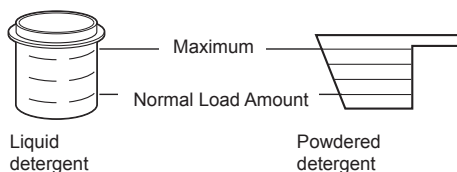

Control Panel

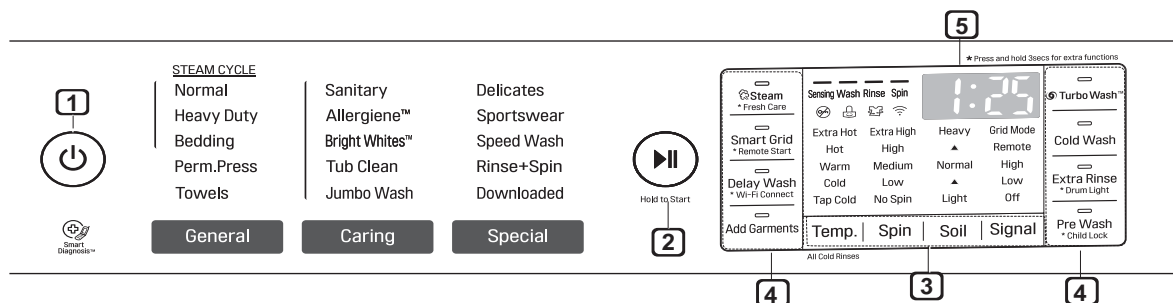

Control Panel Features

1 Power On/Off Button

Press to turn the washer on. Press again to turn the washer off. Pressing the **Power** button during a cycle will cancel that cycle and any load settings will be lost. The door will unlock after a brief pause.

2 Start/Pause Button

Press this button to start the selected cycle. If the washer is running, use this button to pause the cycle without losing the current settings.

NOTE

- If Start/Pause is not pressed within 60 minutes of selecting a cycle, the washer automatically turns off and all cycle settings are lost.

3 Cycle Modifier Buttons

Use these buttons to adjust the water temperature, spin speed and soil level settings for the selected cycle. The current settings are shown in the display. Press the button for that option to select other settings.

4 Special Cycle and Option Buttons

These buttons allow you to select special cycles or additional cycle options. Certain buttons also allow you to activate special functions by pressing and holding the button for three seconds.

5 Time and Status Display

The display shows the settings, estimated time remaining, options, and status messages for your washer. When the washer is turned on, the default settings in the display will illuminate.

Door Lock Indicator

The Door Lock indicator will light up once a cycle has started. The indicator light will stay on until the cycle is paused, stopped or has finished.

Child Lock Indicator

When the Child Lock function is activated, a  message and the remaining wash time are displayed, in turn, on the display panel of the washer. When the Child Lock function is set, all controls are disabled except for the Power button.

Cycle Status Indicator Sensing Wash Rinse Spin

These LEDs will illuminate when a cycle is selected to indicate which stages will run. When a cycle is running, the LED for the active stage will blink, and the LEDs for the remaining stages will remain steady. Once a stage is complete, the LED will turn off. If a cycle is paused, the active stage LED will stop blinking.

Estimated Time Remaining

When a cycle is selected, the default time for that cycle is displayed. This time will change as modifiers or options are selected. Once the **Start/Pause** button is pressed, the washer will measure the size of the load. The estimated time may change once the load size has been measured. If Delay Wash is set, the remaining delay time counts down until the cycle begins.

NOTE

- The time shown is only an estimate. This time is based on normal operating conditions. Several external factors (load size, room temperature, incoming water temperature, etc.) can affect the actual time.

Wash Cycles

Wash cycles are designed for the best wash performance for each type of load. Select the cycle that best matches the load contents for maximum wash performance and fabric care. For best results, follow the fabric care labels on your garments. For a guide to the symbols used on fabric care labels.

Press the button to select the desired cycle. When you select a wash cycle, the light for the corresponding wash cycle will turn on.

NOTE

- Whenever load weights are mentioned, assume 1 lb (0.45 kg) = 1 thick bath towel (dry).
- For information on using SmartThinQ™ applications to save energy, see the Smart Appliance Connectivity section.

Choosing by	Wash Cycle	Description
Fabric Type	Normal	Use this cycle to wash all normal items, except delicate fabrics such as wool or silk. NOTE: Pressing the Start/Pause button without selecting a cycle will cause the Normal cycle to begin immediately, using the default settings.
	Bright Whites™	This cycle is for washing white items only.
	Delicates	This cycle is for washing lingerie or sheer and lacy clothes which can easily be damaged.
	Perm.Press	Use this cycle to wash wrinkle-free clothes or tablecloths, to minimize wrinkles.
	Towels	Use this cycle for washing towels, shirts, jeans and mixed loads.
	Sportswear	Use this cycle for garments that are specially designed and treated for sport.
Load Size	Normal	If you have a mixed load that is half-size, use the Normal cycle with default settings. For full-size loads, use the Normal cycle with the soil level set to heavy, and add an extra rinse. In both cases, the machine will automatically detect the load size and adjust accordingly.
	Speed Wash	Use the Speed Wash cycle to quickly wash lightly soiled clothing and small loads. For high wash and rinse efficiency, wash small loads of 2-3 lightly-soiled garments. NOTE: Use very little detergent in this cycle. For additional, add an extra rinse using the Extra Rinse button.
	Bedding	This cycle is for washing king or queen sized comforters. NOTE: Using the Bedding cycle with a low spin speed is recommended when washing waterproof or water-resistant items, to help protect the fabrics' properties. If your washer does not function properly, manually redistribute the load or put one comforter in at a time.
	Jumbo Wash	This cycle is for washing blankets or bulky items. NOTE: If your washer does not function properly, manually redistribute the load or put one blanket in at a time.

Choosing by	Wash Cycle	Description
Convenience	Speed Wash	Use the Speed Wash cycle to quickly wash lightly soiled clothing and small loads. For high wash and rinse efficiency, wash small loads of 2-3 lightly soiled garments. NOTE: Use very little detergent in this cycle. For additional, add an extra rinse using the Extra Rinse button.
	Rinse+Spin	Select this option to rinse and spin a load separately from a regular cycle. This can be helpful in preventing fresh stains from setting in fabrics. You can change spin speed by pressing Spin repeatedly until the desired speed is selected.
	Tub Clean	Use this cycle to clean the drum of your washer. See the Tub Clean Cycle in the maintenance section.
	Downloaded	If you download a cycle using the Tag On function, it will be placed in the Downloaded cycle position. Choose the Downloaded cycle to run the downloaded cycle. NOTE: The default cycle for this position is small load, used for normally soiled loads with just a few items. The small load cycle is also available for download.
Soil Level	Normal	For tough stains on children's clothes, use the Normal cycle with a hot Wash Temp. setting, plus the Pre Wash option and an Extra Rinse.
	Heavy Duty	This cycle is for washing heavily soiled laundry using more powerful wash motions.
	Allergiene™	This cycle is a powerful, high-temperature cycle designed specifically to reduce certain allergens. NOTE <ul style="list-style-type: none"> • Selecting the Allergiene™ cycle automatically incorporates steam into the wash cycle. • The Allergiene™ cycle can significantly reduce allergens in bedding and clothing. • The Allergiene™ cycle helps reduce dust mite populations and helps reduce allergens. Due to the higher energy and temperatures used, the Allergiene™ cycle is not recommended for wool, silk, leather, or any other delicate or temperature sensitive items.
	Sanitary	NSF International (formerly the National Sanitation Foundation), certifies that his wash cycle reduces 99.9% of bacteria on laundry when used in conjunction with bleach, without high energy consumption.



Protocol P172 Sanitization Performance of Residential and Commercial, Family Sized Clothes Washers

NOTE

- This cycle has been certified by NSF using Tide HE powder.

Cycle Guide

Cycle	Cycle Modifiers	Wash Temp.	Spin Speed	Soil Level	Delay Wash	Extra Rinse
Bright Whites™			Extra High	Heavy	•	•
	Turbo Wash™	Hot	High			
	Steam	Warm	Medium	Normal		
	Pre Wash	Cold	Low			
		Tap Cold	No Spin	Light		
Allergiene™			Extra High		•	•
	Turbo Wash™		High			
	Steam		Medium			
			Low			
			No Spin			
Sanitary		Extra Hot	Extra High	Heavy	•	•
	Turbo Wash™		High			
	Steam		Medium	Normal		
	Pre Wash		Low			
			No Spin	Light		
Bedding				Heavy	•	•
	Turbo Wash™	Hot				
	Steam	Warm	Medium	Normal		
	Cold Wash	Cold	Low			
	Pre Wash	Tap Cold	No Spin	Light		

NOTE

- = available option, ■ = default setting
- Steam and Cold wash can't be selected at same time.

Cycle	Cycle Modifiers	Wash Temp.	Spin Speed	Soil Level	Delay Wash	Extra Rinse
Heavy Duty		Extra Hot	Extra High	Heavy	•	•
	Turbo Wash™	Hot	High			
	Steam	Warm	Medium	Normal		
	Cold Wash	Cold	Low			
	Pre Wash	Tap Cold		Light		
Normal		Extra Hot	Extra High	Heavy	•	•
	Turbo Wash™	Hot	High			
	Steam	Warm	Medium	Normal		
	Cold Wash	Cold	Low			
	Pre Wash	Tap Cold		Light		
Jumbo Wash				Heavy	•	•
	Turbo Wash™	Hot	High			
	Steam	Warm	Medium	Normal		
	Cold Wash	Cold	Low			
	Pre Wash	Tap Cold	No Spin	Light		
Perm.Press				Heavy	•	•
		Hot	High			
	Turbo Wash™	Warm	Medium	Normal		
	Cold Wash	Cold	Low			
	Pre Wash	Tap Cold		Light		

NOTE

- = available option, = default setting
- Steam and Cold wash can't be selected at same time.

Cycle	Cycle Modifiers	Wash Temp.	Spin Speed	Soil Level	Delay Wash	Extra Rinse
Delicates				Heavy	•	•
	Pre Wash	Warm	Medium	Normal		
	Cold Wash	Cold	Low			
		Tap Cold	No Spin	Light		
Towels			Extra High	Heavy	•	•
		Hot	High			
	Turbo Wash™	Warm	Medium	Normal		
	Cold Wash	Cold	Low			
Speed Wash			Extra High	Heavy	•	•
		Hot	High			
	Turbo Wash™	Warm	Medium	Normal		
	Cold Wash	Cold	Low			
Rinse+Spin		Extra Hot	Extra High		•	•
		Hot	High			
		Warm	Medium			
		Cold	Low			
		Tap Cold	No Spin			

NOTE

- = available option, = default setting
- Steam and Cold wash can't be selected at same time.

Cycle	Cycle Modifiers	Wash Temp.	Spin Speed	Soil Level	Delay Wash	Extra Rinse
Tub Clean					•	
	Steam					
Sportswear				Heavy	•	•
		Warm	Medium	Normal		
		Cold	Low			
		Tap Cold	No Spin	Light		
Downloaded Default: Small Load			Extra High	Heavy	•	•
		Hot	High			
	Pre Wash	Warm	Medium	Normal		
	Cold Wash	Cold	Low			
		Tap Cold	No Spin	Light		

NOTE

- = available option, = default setting
- Steam and Cold wash can't be selected at same time.

Cycle Modifier Buttons

Each cycle has default settings that are selected automatically. You may also customize these settings using the cycle modifier buttons. Press the button for the desired modifier until the indicator light for the desired setting is lit. The washer automatically adjusts the water level for the type and size of wash load for best results and maximum efficiency. Due to the high-efficiency nature of this product, water levels may be much lower than expected. This is normal and cleaning/rinsing performance will not be compromised.

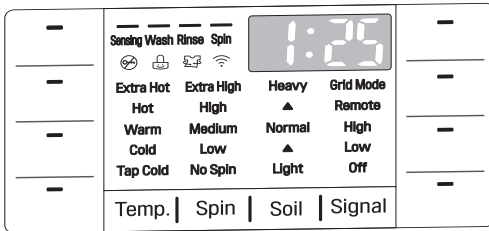

Temp.

Temp. selects the wash and rinse temperature combination for the selected cycle. Press the **Temp.** button until the indicator light for the desired setting is lit. All rinses use tap cold water .

Cold rinses use less energy. The actual cold rinse temperature depends on the temperature of the cold water at the faucet.

Your washer features a heating element to boost the hot water temperature for Extra Hot settings. This provides improved wash performance at normal water heater settings.

NOTE

- Select the water temperature suitable for the type of load you are washing. Follow the garment fabric care labels for best results.
- Warm rinses are regulated at approximately 74 °F (23 °C).
- Warm rinses leave the clothes dryer than cold rinses, but will result in increased energy consumption and greater wrinkling of clothes.

Spin

Higher spin speeds extract more water from clothes, reducing drying time and saving energy. Press the **Spin** button until the desired speed is selected. Some fabrics, such as delicates, require a slower spin speed. To protect your clothing, not all spin speeds are available for all cycles.

- The Spin button also activates the Drain+Spin cycle to drain the tub and spin clothes; for example, if you want to remove clothes before the cycle has ended. To use Drain+Spin, press the **Power** button, then press the **Spin** button repeatedly to select a spin speed. Press the **Start/Pause** button to begin.

Soil

Adjusting the soil level setting will modify the cycle times and/or wash actions. Press the **Soil** button until the desired soil level is selected.

NOTE

- This feature needs more time for heavily soiled loads or less time for lightly soiled loads.

Signal

The washer plays a melody when the wash cycle is finished. The buttons make a sound each time a button is pressed. Use this option to adjust the volume of the melody and button tones.

Special Cycles/Features

After selecting a cycle, press the buttons to select additional features for your load.

NOTE

- To protect your garments, not every feature is available with every cycle.
- If the Start/Pause button is not pressed within 60 minutes to start the cycle, the control will shut off and all settings will be lost.

Pre Wash

Pre-wash for 15 minutes when clothes are covered in dirt or dust. This feature is suitable for heavily soiled items.

Rinse+Spin

Select this cycle to rinse and spin a load separately from a regular cycle. This can be helpful in preventing fresh stains from setting in fabrics. You can change the spin speed by pressing the **Spin** button.

- 1 Press the **Power** button to turn on the washer.
- 2 Press the special use button until the Rinse+Spin indicator light is lit.
- 3 Press the **Start/Pause** button to start the cycle.

Drum Light

The drum is equipped with a white LED light that illuminates when the washer is turned on. This light automatically turns off when the door is closed and the cycle starts.

- Press and hold the **Extra Rinse** button for three seconds during the cycle to turn on the drum light.
- The drum light will turn off automatically after four minutes.

Option Buttons

Your washer features several additional cycle options that customize cycles to meet your individual needs. To use these options, select the desired option after selecting the desired cycle.

After selecting the desired cycle and settings, press the cycle option button(s) for the option(s) you would like to add. The button will light when that option is selected. If the selected option is not allowed for the selected cycle, the chime will sound twice to alert you and the LED will not illuminate.

NOTE

- To protect your garments, not every feature is available with every cycle.
- If the Start/Pause button is not pressed within 60 minutes to start the cycle, the control will shut off and all settings will be lost.

Delay Wash

Once you have selected the cycle and other settings, press this button to delay the start of the wash cycle. Each press of the button increases the delay time by 1 hour, for up to 19 hours. Once the desired delay time is set, press the **Start/Pause** button to start the delay time.

NOTE

- If the Start/Pause button is not pressed to begin the delay time, the washer will automatically shut off after 60 minutes and all cycle settings will be lost.

Extra Rinse

This option will add an extra rinse to the selected cycle. Use this option to help ensure the removal of detergent or bleach residue from fabrics. Liquid fabric softener, if used, is always dispensed in the final rinse. Pressing the **Extra Rinse** button twice will add two additional rinses to the cycle.

Fresh Care

Use this function when you won't be able to take out your clothes immediately after the wash cycle ends. After the cycle ends, the drum will tumble periodically for up to 19 hours to prevent wrinkles. Press the **Start/Pause** or **Power** button at any time to unload laundry.

Press and hold the **Steam** button for three seconds during the wash cycle to activate the Fresh Care function.

Cold Wash

This option saves energy by using cooler water while increasing the wash and rinse times to maintain wash performance.

NOTE

- Wash time will increase up to several minutes with the Cold Wash option.
- For best wash results, only wash small loads (less than 8 lb) with the Cold Wash option.

Add Garments

Use this function to add garments or remove foreign objects like coins or keys after the cycle has started.

- 1 Press **Add Garments**. The cycle pauses and the door unlocks.
- 2 Open the door, add garments or remove foreign objects, and close the door.
- 3 Press the **Start/Pause** button to start the cycle. The cycle continues automatically.

NOTE

- After checking the water level/temperature conditions for safety, the door unlocks once the wash movement has stopped. (Door Lock LED turns off.)
- This may take several seconds depending on the water level. When a lot of water is in the tub, the door unlocks after water drains to a safe level.
- If the temperature in the tub is higher than 113 °F (45 °C), a short warning chime sounds and Add Garments is not allowed for safety.
- Add Garments is disabled during the Tub Clean cycle or while a cycle is in Spin mode for safety.
- To preserve wash performance, wash time may be extended depending on when garments are added to a cycle.

WARNING

- Be careful when opening the door as wet laundry may drip or fall out when the door is opened.
- Do not attempt to force the door to open when locked. Doing so could result in damage to the machine, malfunction, or personal injury.

Child Lock

Use this option to disable the controls. This feature can prevent children from changing cycles or operating the machine. The feature does not lock the lid. Once the Child Lock is set, it must be deactivated before any controls, except the Power button, can be used. Once the washer has shut off, the Power button will allow the machine to be turned on, but the controls will still be locked. When the controls are locked,  will display alternately with the estimated time remaining. Press and hold the **Pre Wash** button for seconds to activate or deactivate Child Lock.

NOTE

- Once the controls are locked, they must be manually unlocked to restore operation.

Turbo Wash™

Adding the Turbo Wash™ option reduces the cycle time while still providing similar wash performance to the same cycle without Turbo Wash™.

NOTE

- The Turbo Wash™ option cannot be used with all cycles.
- Turbo Wash™ defaults to on for Normal, Heavy Duty and Perm.Press wash cycles.

Steam

Adding the Steam option to a wash cycle helps provide superior cleaning performance. By using hot steam, the fabrics will get the cleaning benefits of a very hot wash.

NOTE

- The Steam option cannot be used with all cycles.
- Steam may not be clearly visible during the steam cycles. This is normal. Too much steam could damage clothing.
- Do not use steam with delicate fabrics such as wool, silk, or easily discolored fabrics.

WARNING

- Do not touch the door during steam cycles. The door surface can become very hot. Allow the door lock to release before opening the door.
- Do not attempt to override the door lock mechanism or reach into the washer during a steam cycle. Steam can cause severe burns.

SMART FUNCTIONS

Smart Appliance Connectivity

Connectivity Overview

This smart appliance offers options for doing laundry. Once it is connected to the internet through a home Wi-Fi network, it can check the progress of a cycle and control the appliance remotely with the LG Smart Laundry & DW application for the smart phone.

The application can be set up to send push notifications when the cycle is complete or the appliance has problems. It also provides a list of extra cycles available for download, and helps to troubleshoot problems by recording and analyzing data from the appliance. The appliance has Smart Grid capability for areas where the utility company has installed Smart Grid equipment. This feature adjusts the appliance operating times based on when electricity prices are lower or delays operation when the demand for electricity is high.

Connectivity Setup

Installing LG Smart Laundry & DW Application

- 1 Run the Google Play Store on an Android smart phone.
- 2 Search for LG Smart Laundry & DW.
- 3 Press **LG Smart Laundry & DW** on the resulting list.
- 4 Press **Install** and **Accept** to automatically install the application. You can also check the progress through the smart phone.
- 5 When the installation is complete, touch the icon to access the application.

- LG Smart Laundry & DW application for iOS devices will be supported later.

Profile Setup (ID and Password Setup)

You can skip these steps if you already have an LG account at <http://us.smartthinQ.com>

- 1 Run the LG Smart Laundry & DW application on a smart phone.
- 2 Select **Login** at the bottom of the screen.
- 3 Select **Create an account** at the bottom of the screen.
- 4 On the next page, agree to the Terms and Conditions, Privacy Policy, and LG Account Terms and Conditions. After selecting **I agree**, press **Confirm**.
- 5 Next, in the email box, enter your email address. This will be your user ID. You will receive a confirmation email for activating the account at that email address.
- 6 Enter a password. Passwords are case sensitive. The password should be 6-12 characters. Remember your ID and password. They will be used on the LG Smart Laundry & DW application to use Smart Appliance Connectivity functions.
- 7 Enter your name.
- 8 Enter your mobile number.
- 9 Press the **Subscribe** button. The system will send you an email containing a link to confirm your identity for the account.
- 10 Press the **Confirm** button in the confirmation email, and the website will display a confirmation page. Your account is now set up.

Product Registration and Wi-Fi Setup

- 1 Run the LG Smart Laundry & DW application on a smart phone.
- 2 Select **Smart Appliance**.
- 3 Select **Washer**.
- 4 Select **Front Load**.
 - If you see a pop-up message about NFC, press the Cancel button.
- 5 Press the **Wi-Fi model** button at the bottom of the screen.
- 6 Enter the email ID and password you registered.

If you don't have an account at <http://us.smarthinQ.com>, press the **Create an account** button and create a user ID and password.
- 7 Select the **Login** button.
- 8 On the next page, the application shows the Wi-Fi network list. Select your home network. If your network requires a key, enter the password and select the **Connect** button.
- 9 If the application successfully connects to the home network, turn on the washer and then press and hold the **Wi-Fi Connect** button on the washer for three seconds.

After powering on the washer, do not press any other buttons before pressing and holding the **Wi-Fi Connect** button. The Wi-Fi connection indicator on the washer blinks to indicate the machine is connecting.
- 10 The application now works to connect the appliance and register it as a Wi-Fi product. A notification appears when the washer is successfully set up and the product registration and Wi-Fi setup is complete. The Wi-Fi connection indicator illuminates when the machine connects to the home network.

NOTE

- LG electronics is not responsible for any network connection problems or any faults, malfunctions, or errors caused by network connection.
- The machine supports 2.4 GHz Wi-Fi networks only.
- Use the Settings menu in the application to register or change the machine. Select Settings > Change Product > Add Product and then follow steps 2–10 above.
- If the router or the router's password is changed, select Settings > Change Product > Add Product and then follow steps 2–10 above.
- If the appliance is having trouble connecting to the Wi-Fi network, it may be too far from the router. Purchase a Wi-Fi repeater (range extender) to improve the Wi-Fi signal strength.
- The Wi-Fi connection may not connect or may be interrupted because of the home network environment.
- The network connection may not work properly depending on the Internet service provider.
- The surrounding wireless environment can make the wireless network service run slowly.
- This information is current at the time of publication. The application is subject to change for product improvement purposes without notice to users.

Smart ThinQ™

Remote Start

Use a smart phone to control the appliance remotely. Or monitor the cycle operation to see the remaining time left in the cycle.

NOTE

- You must first connect to a gateway and register the appliance in order to use the Remote Start.
- The Remote LED on the control panel should be illuminated.

Using Remote Start

- 1 Press and hold the **Remote Start** button. The Remote LED on the control panel is illuminated if the appliance is connected to a Wi-Fi network.
- 2 Start a cycle from the application on a smart phone. If the cycle is not started, the machine will wait to start the cycle until it is turned off remotely from the application or the Remote Start mode is disabled.

NOTE

- Cycles and options cannot be selected at the appliance when the machine is in Remote Start mode.
- Press and hold the **Remote Start** button again to enable the Remote Start mode when the appliance is turned off or the Remote Start mode is released.

Smart Grid

Reduce energy costs from washing clothes by avoiding peak usage periods, with information supplied by the local electric utility company. If the utility company has equipped Smart Grid technology, contact the utility company for information regarding the Smart Grid features.

NOTE

- When Smart Grid is enabled, you may experience delays or extended cycle times during peak usage periods.
- You must first connect to a gateway and register the appliance in order to use the Smart Grid function.

Download Cycle

Download new and special cycles that are not included in the basic cycles on the appliance.

Appliances that have been successfully registered can download a variety of specialty cycles specific to the appliance.

Only one cycle can be stored on the appliance at a time. Once Download Cycle is completed in the washer, the product keeps the downloaded cycle until a new cycle is downloaded.

NOTE

- You must first connect to a gateway and register the appliance in order to use the Download cycle function.

Smart Diagnosis™

Use a phone to record the Smart Diagnosis™ signal to solve problems with the appliance. The application can analyze the signal and help you solve the problem without waiting for a technician.

Cycle Set

Choose the best cycle and settings based on laundry needs. Once you have selected a cycle based on the Cycle Set guide, the cycle and settings are automatically set.

NOTE

- Cycle Set function can be enabled when the Remote Start button is activated.

Laundry Stats

Learn basic stats about the appliance such as the cycle history and basic maintenance timing. Select **Laundry Stats** at the application to get the stats and find out when the washer's next Tub Clean is due.

NOTE

- You must first connect to a gateway and register the appliance in order to use the Laundry Stats function.

Smart Message

When the cycle is complete or the appliance has problems, you have the option of receiving push notifications on a smart phone.

NOTE

- You must first connect to a gateway and register the appliance in order to use the Smart Message function.

Energy Monitoring

The washer energy usage is affected by the cycle and options so you may see some changes in energy usage from one cycle to another.

NOTE

- You must first connect to a gateway and register the appliance in order to use the Energy Monitoring function.

Open Source Software Notice Information

To obtain the source code under GPL, LGPL, MPL, and other open source licenses, that is contained in this product, please visit <http://opensource.lge.com>.

In addition to the source code, all referred license terms, warranty disclaimers and copyright notices are available for download.

LG Electronics will also provide open source code to you on CD-ROM for a charge covering the cost of performing such distribution (such as the cost of media, shipping, and handling) upon email request to opensource@lge.com. This offer is valid for three (3) years from the date on which you purchased the product.

Wireless Module (LCW-003) Specifications	
Frequency Range	2412~2462 MHz
Output Power (max.)	IEEE 802.11 b : 14 dBm
	IEEE 802.11 g : 15 dBm
	IEEE 802.11 n : 14 dBm

FCC Notice (For transmitter module contained in this product)

This equipment has been tested and found to comply with the limits for a Class B digital device, pursuant to Part 15 of the FCC Rules. These limits are designed to provide reasonable protection against harmful interference in a residential installation. This equipment generates, uses, and can radiate radio frequency energy and, if not installed and used in accordance with the instructions, may cause harmful interference to radio communications. However, there is no guarantee that interference will not occur in a particular installation. If this equipment does cause harmful interference to radio or television reception, which can be determined by turning the equipment off and on, the user is encouraged to try to correct the interference by one or more of the following measures:

- Reorient or relocate the receiving antenna.
- Increase the separation between the equipment and the receiver.
- Connect the equipment to an outlet on a circuit different from that to which the receiver is connected.
- Consult the dealer or an experienced radio/TV technician for help.

This device complies with part 15 of the FCC Rules. Operation is subject to the following two conditions:

- 1) this device may not cause harmful interference and
- 2) this device must accept any interference received, including interference that may cause undesired operation of the device.

Any changes or modifications in construction of this device which are not expressly approved by the party responsible for compliance could void the user's authority to operate the equipment.

FCC RF Radiation Exposure Statement

This equipment complies with FCC radiation exposure limits set forth for an uncontrolled environment. This transmitter must not be co-located or operating in conjunction with any other antenna or transmitter.

This equipment should be installed and operated with minimum distance 20 cm (7.8 inches) between the antenna and your body. Users must follow the specific operating instructions for satisfying RF exposure compliance.

Using Smart Diagnosis™

Should you experience any problems with your washer, it has the capability of transmitting data to your smart phone using the LG Smart Laundry & DW application or via your telephone to the LG call center.

Smart Diagnosis™ cannot be activated unless your washer is turned on by pressing the **Power** button. If your washer is unable to turn on, then troubleshooting must be done without using Smart Diagnosis™.

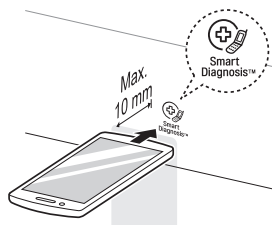

Smart Diagnosis™ Through The Customer Information Center

- 1 Call the LG call center at:
(USA) 1-800-984-6306
- 2 When instructed to do so by the call center agent, hold the mouthpiece of your phone over the Smart Diagnosis™ logo on the machine. Hold the phone no more than one inch from (but not touching) the machine.
- 3 Press and hold **Temp.** for three seconds.

NOTE

- Do not touch any other buttons or icons on the display screen.
- 4 Keep the phone in place until the tone transmission has finished. The display will count down the time.
 - 5 Once the countdown is over and the tones have stopped, resume your conversation with the call center agent, who will then be able to assist you in using the information transmitted for analysis.

NOTE

- For best results, do not move the phone while the tones are being transmitted.
- If the call center agent is not able to get an accurate recording of the data, you may be asked to try again.

MAINTENANCE

WARNING

To reduce the risk of fire, electric shock, or injury to persons, read and follow this entire Owner's Manual, including the Important Safety Instructions, before operating this washer.

- Unplug the washer before cleaning to avoid the risk of electric shock. Failure to follow this warning can cause serious injury, fire, electric shock, or death.
- Do not use volatile substances (benzene, paint thinner, alcohol, acetone, etc.) or detergents with strong chemical components when cleaning the washer. Doing so may cause discoloration or damage to the machine, or may cause a fire.

NOTE

- Never use harsh chemicals, abrasive cleaners, or solvents to clean the washer. They will damage the finish.

Regular Cleaning

Care After Wash

After the cycle is finished, wipe the door and the inside of the door seal to remove any moisture.

- Leave the door open to dry the drum interior.
- Wipe the body of the washer with a dry cloth to remove any moisture.

Cleaning the Exterior

Proper care of your washer can extend its life.

Door:

Wash with a damp cloth on the outside and inside and then dry with a soft cloth.

Exterior:

- Immediately wipe off any spills.
- Wipe with a damp cloth.
- Do not touch the surface or the display with sharp objects.

Care and Cleaning of the Interior

- Use a towel or soft cloth to wipe around the washer door opening and door glass.
- Always remove items from the washer as soon as the cycle is complete. Leaving damp items in the washer can cause wrinkling, color transfer, and odor.
- Run the Tub Clean cycle once a month, or more often if needed, to remove detergent buildup and other residue.

Tub Clean Cycle

- Some environmental and usage conditions can cause a residue to build up in the drum over time and can lead to a mildewy or musty smell. The Tub Clean cycle is specially designed to remove this buildup using bleach or other cleaners designed specifically for cleaning washers. Run the Tub Clean cycle once a month, or more often under heavy use conditions or if odor is present.

- 1 Remove any clothing from the drum.
- 2 Add cleaning agents.
 - For other drum cleaning products, follow the cleaner manufacturer's instructions and recommendations.
 - Do not exceed the maximum fill line when adding bleach or powdered cleaners. Powdered detergent may remain in the drum after cleaning.
- 3 Close the door and press the **Power** button to turn the washer on.
- 4 Turn the cycle selector to select the **Tub Clean** cycle.
- 5 Press the **Start/Pause** button to begin the cycle. Selecting any other cycle after Tub Clean has been selected will cause the Tub Clean cycle to be cancelled.
- 6 After the cycle ends, open the door and allow the drum interior to dry completely.

Cleaner	Instructions
Tub cleaner	Add to main detergent compartment of detergent dispenser lid
Lime scale remover	
Liquid chlorine bleach	Add to bleach compartment of detergent dispenser lid
Powdered cleaner	Pull out liquid detergent cup before adding to main detergent compartment
Cleaning tablets	Place directly into washer drum

NOTE

- Never load laundry while using Tub Clean. The laundry may be damaged or contaminated with cleaning products. Make sure to run the Tub Clean cycle only when the drum is empty.
- Leave the door open after finishing the laundry, to keep the drum clean.
- Tub Clean should be repeated monthly.
- If mildew or musty smell already exists, run Tub Clean once a week for three consecutive weeks.
- For other drum cleaning products, follow the cleaner manufacturer's instructions and recommendations.
- Do not exceed the maximum fill line when adding bleach or powdered cleaners. Powdered detergent may remain in the drum after cleaning.

Automatic Alert for Tub Clean

When the power is on and the **L L L** message blinks on the display, it means the washer drum needs cleaning. Use the Tub Clean cycle to clean the washer drum. The frequency of the automatic alert's appearance depends on how often the washer is used, however the message will generally appear every one to two months.

Removing Mineral Buildup

In areas with hard water, mineral scale can form on internal components of the washer. Periodically clean the mineral buildup on the internal components to extend the lifespan of the washer. Use of a water softener is recommended in areas with hard water.

- Use a descaler, such as Washer Magic®, to remove visible mineral buildup on the washer drum.

After descaling, always run the Tub Clean cycle before washing clothing.

- Mineral scale and other spots may be removed from the stainless steel drum using a soft cloth soaked in stainless steel cleaner.
- Do not use steel wool or abrasive cleaners.

Cleaning the Dispenser Lid

Detergent and fabric softener may build up in the dispenser lid. Remove the lid and inserts and check for buildup once or twice a month.

- 1 Slide the detergent dispenser lid open.
- 2 Remove the detergent dispenser covers and pull out the detergent cups.

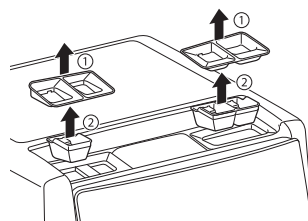

- 3 Clean parts with warm water.
 - Use a soft cloth or brush for cleaning and to remove any residue.

! WARNING

- Do not spray water inside the cabinet. Doing so may cause fire or electric shock.

- 4 Wipe off any moisture with a dry towel or cloth after cleaning.
- 5 Replace the detergent cups and detergent dispenser covers.

NOTE

- If you use a descaler or tub cleaner during the Tub Clean cycle, use the Rinse+Spin cycle to rinse the washer drum before running your next wash cycle.

Cleaning the Door Seal

Clean the door seal once a month to prevent build-up of dirt.

- 1 Wear rubber gloves and protective goggles.**
- 2 Dilute 3/4 cup (177 ml) of liquid chlorine bleach in 1 gallon (3.8 L) of water.**
- 3 Wipe around the door seal.**
Soak a sponge or a soft cloth in this diluted solution and wipe all around the door seal.
- 4 Wipe dry.**
After cleaning, wipe up any moisture with a dry towel or cloth.
- 5 Leave the door open to allow the door seal to dry completely.**

CAUTION

- Cleaning the door seal with undiluted bleach may cause malfunction of the door seal and washer parts. You must add water to the bleach before using it.

Cleaning the Water Inlet Filters

If the washer does not fill properly, an error message will show on the display. The inlet valve filter screens could be plugged by hard water scale, sediment in the water supply, or other debris.

CAUTION

- The inlet screens protect the delicate parts of the inlet valve from being damaged by particles that could enter the valves with the water supply. Operating the washer with these filters removed could cause a valve to stick open resulting in flooding and/or property damage
- Do not use the washer without the inlet filters. If you use the washer without the inlet filters it will cause leaks and malfunction.
- If you use the washer in an area with hard water, the inlet filter may clog due to lime buildup.

- 1 Turn off both water faucets completely.**
- 2 Unscrew the hot and cold water hoses from the back of the washer.**
- 3 Carefully remove the filters from the water valves.**
- 4 Remove foreign objects and soak the filters in white vinegar or a lime scale remover.**
If using a lime scale remover, follow the manufacturer's instructions. Be careful not to damage the filters while cleaning them.
- 5 Rinse filters thoroughly and press them back into place.**
- 6 Flush then reattach the water hoses.**
Before reattaching the hoses, flush the hoses and water lines by running several gallons of water into a bucket or drain, preferably with the faucets wide open for maximum flow.

NOTE

- An *IE* message may blink on the display when the water pressure is weak or an inlet filter is clogged with dirt. Clean the inlet filter.

Cleaning the Drain Pump Filter

The washer fails to drain if the drain pump filter is clogged. Periodically clean the drain filter to prevent clogging with foreign objects.

! WARNING

- Opening the drain filter will result in water overflowing if there is water in the washer drum. Use a bucket if the drum is not completely drained before you open the drain filter.
- Using the washer without the drain filter or with an incorrectly assembled drain filter may cause leaks or malfunctioning of the washer.

1 Turn off the machine and pull out the plug.

2 Open the drain pump filter cover.

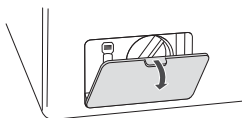

3 Drain any remaining water.

Unclip the drain hose and remove the plug from the drain hose to drain the remaining water.

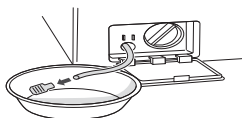

4 Remove the pump filter.

Twist the pump filter counterclockwise to remove.

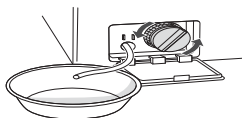

5 Clean the pump filter and opening.

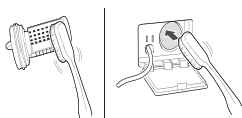

6 Recap the plug onto the drain hose and attach the drain hose.

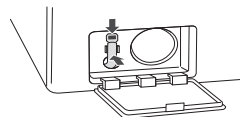

7 Insert the drain pump filter.

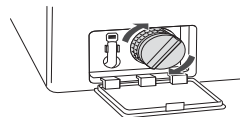

8 Close the drain pump filter cover.

NOTE

- An **DE** message blinks on the display when the drain pump filter is clogged with dirt. Clean the drain pump filter.

Care in Cold Climates

Storing the Washer

If the washer will not be used for an extended period of time and is in an area that could be exposed to freezing temperatures, perform the following steps to protect the washer from damage.

- 1 Turn off the water supply.
- 2 Disconnect hoses from water supply and drain water from hoses.

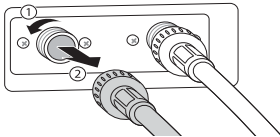

- 3 Plug the power cord into a properly grounded electrical outlet.
Soak a sponge or a soft cloth in this diluted solution and wipe all around the door seal.
- 4 Add 1 gallon of nontoxic recreational vehicle (RV) antifreeze to the empty drum and close the door. Never use automotive antifreeze.
- 5 Press the **Power** button, then select **Spin**.
- 6 Press the **Start/Pause** button to start the drain pump.
- 7 Allow the drain pump to run for one minute, then press the **Power** button to shut off the washer. This will expel some of the antifreeze, leaving enough to protect the washer from damage.
- 8 Unplug the power cord, dry the drum interior with a soft cloth, and close the door.
- 9 Remove the inserts from the dispenser. Drain any water in the compartments and let them dry.
- 10 Store the washer in an upright position.
- 11 To remove the antifreeze from the washer after storage, run a complete Speed Wash cycle using detergent.
Do not add laundry to this cycle.

When the Water Line is Frozen

- 1 Turn off the faucets connected with the water lines.
- 2 Pour hot water on the frozen faucets to thaw the water lines and remove them.
- 3 Immerse the water lines in hot water to thaw them.
- 4 Connect the water lines with the water inlets of the washer and with the faucets.
See Connecting the Water Lines for details.
- 5 Turn on the faucets.
- 6 Press the **Power** button.
- 7 Press the **Spin** button.
- 8 Press the **Start/Pause** button. Verify the water fills properly.

When the Drain Line is Frozen

- 1 Pour hot water in the washer drum and close the lid. Wait for 1-2 hours.
- 2 Press the **Power** button after thawing.
- 3 Press the **Spin** button to select draining and spinning.
- 4 Press the **Start/Pause** button. Check to make sure the water drains.