













# ALTOS HOME

## ASSEMBLY INSTRUCTIONS MANHATTAN BED FRAME

HARDWARE LIST BOX 2			PARTS LIST BOX 1		PARTS LIST BOX 2		PARTS LIST BOX 3	
PART		QTY	PART	QTY	PART	QTY	PART	QTY
A	JCBC SCREW		FOOTBOARD	2 PCS	SIDE RAIL	2 PCS	MATTRESS SLATS	12 PCS
B	SPRING WASHER							
C	ALLEN KEY M4				CENTER SUPPORT	1 PC		
D	SCREW M4 x 30mm							
E	ALLEN KEY M5				CENTER LEG	4 PCS		
F	L - BRACKET							
G	SCREW M4 x 16mm				HARDWARES	1 BAG		
								

CAUTIONS : Hardware are to be kept out of reach from children.

### STEP 1

Remove the "screw" on bracket of FOOTBOARD , assembly the SIDE RAIL to FOOTBOARD with fix back the existing "screw" to the existing bracket insertion hole.

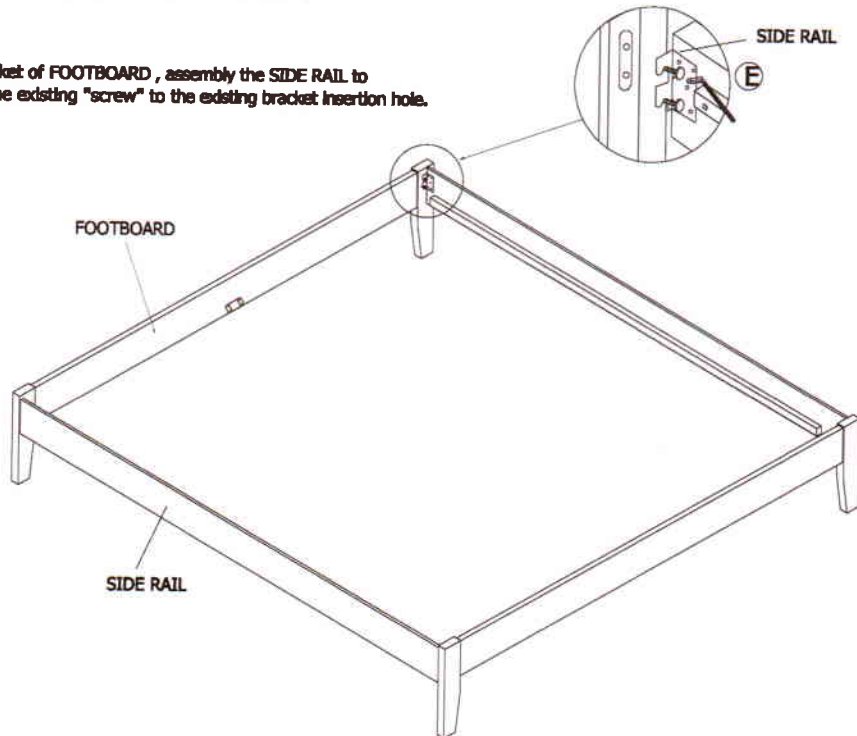

# ALTOS HOME

## ASSEMBLY INSTRUCTIONS MANHATTAN BED FRAME

### STEP 2

Attach L- BRACKET onto the CENTER SUPPORT ,fix the L-BRACKET with hardware "G" by using screw driver.

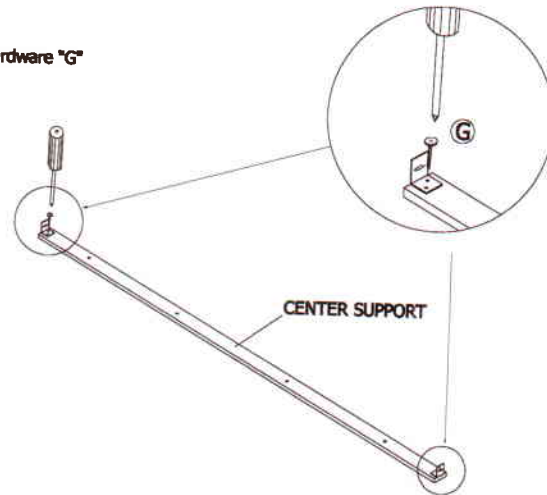

### STEP 3

Attach all mattress slat onto the SIDE RAIL , attach hardware "A" with "B" by using ALLEN KEY "C" to assembly the CENTER LEG thru the pre-drilled hole on MATTRESS SLAT and CENTER SUPPORT .

### STEP 4

Lastly, fix the mattress slat with hardware "D" thru pre-drilled hole by using screw-driver. (NOT INCLUDED)

