

Assembly Instructions

Loveseat

CAUTION : You must read this before you proceed.

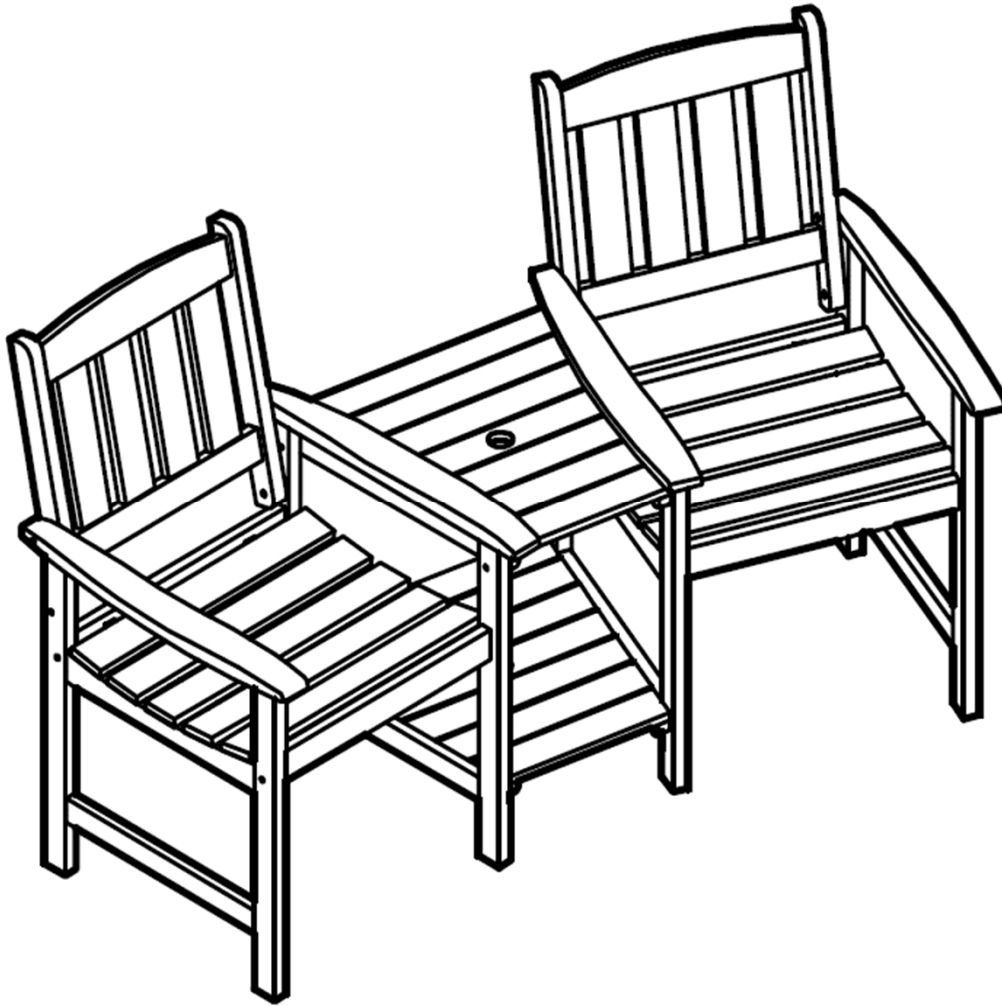



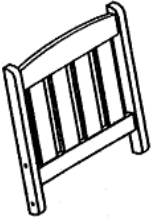
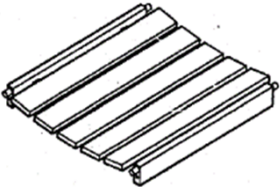
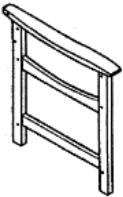
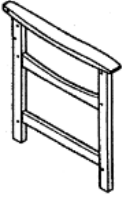
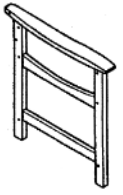
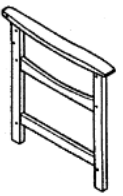
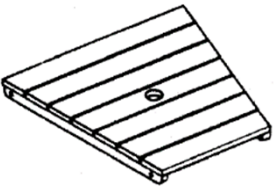
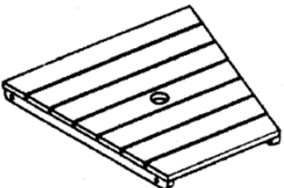

CAUTION : This set is NOT a TOY.

Keep your child / children at bay in the process of assembly.
For turning / flipping the Loveseat and to prevent damage, 02 persons may be needed to execute this action.

Parts List

No.	Picture	Description	Qty
A		Backrest Panels	2
B		Seat Panels	2
C1		Left Chair : Left Leg Panel (labeled C1)	1
C2		Left Chair : Right Leg Panel (labeled C2)	1
C3		Right Chair : Left Leg Panel (labeled C3)	1
C4		Right Chair : Right Leg Panel (labeled C4)	1
D1		Table Bottom Shelf	1
D2		Table Top Shelf	1

Hardware

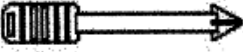
No.	Picture	Description	Qty
①		Short Screws (M6*40mm)	16
②		Long Screws (M6*60mm)	8
③		JRN Nut	8
④		Allen Key	1
⑤		Screw Bit	1

Assembly Preparation

Before Beginning Assembly:

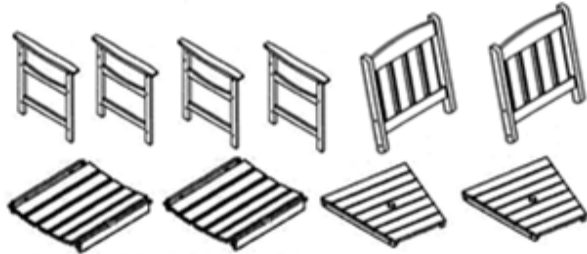
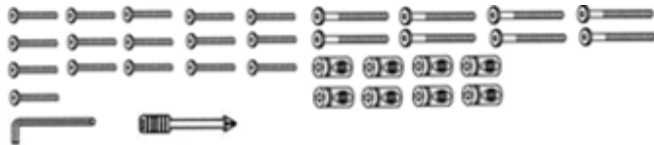

- Read instructions, cover to cover-



- Have 2 adults on hand for assembly-



- Do not assemble on flooring or carpet-



- Assemble on a clean non-marring surface (packing foam)-



- Save all packaging until finished-

Assembly Steps

OVERVIEW

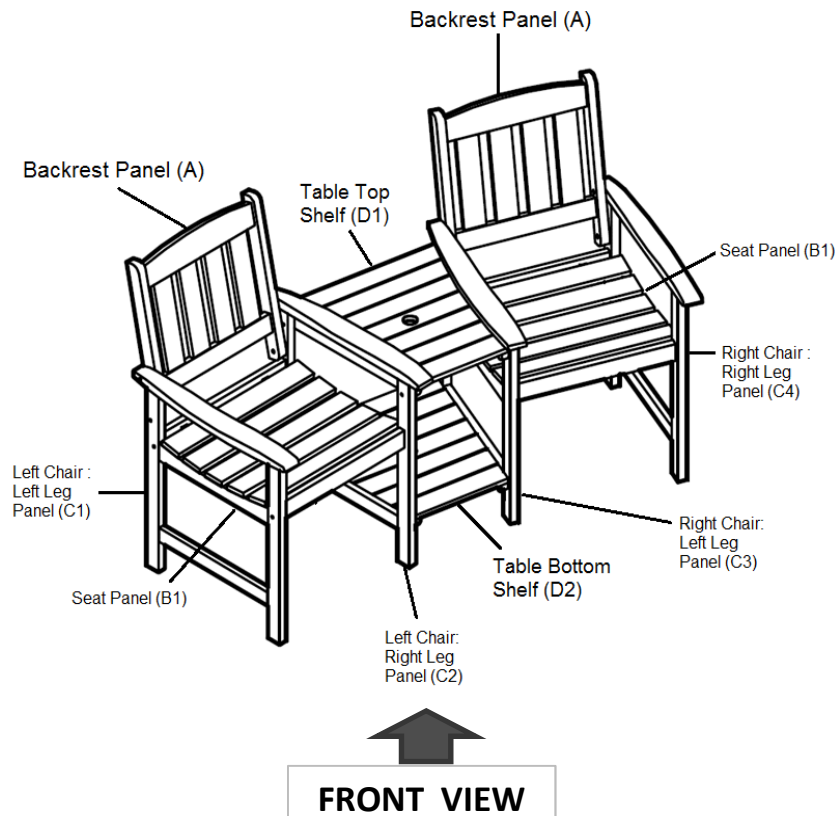

This Loveseat has multiple parts and may require up to some 30 minutes to assemble. To give you an overview of the Loveseat parts, the above picture is to help you put the various parts into perspective. Please read through the instructions herebelow to familiarise the parts and steps before assembly.

Step 1

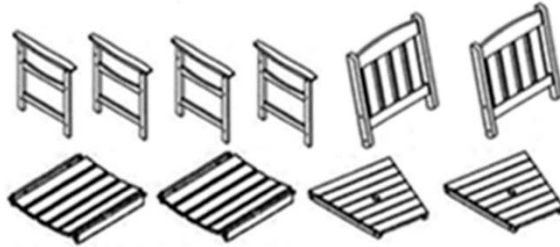

Unpack and place all parts on a clean non marring flat surface .

Step 2

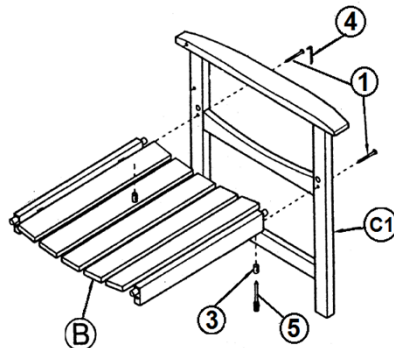

Place Left Leg Panel of Left Chair (C1) with inside facing skywards.
Then insert the tenon of the Seat Panel (B) to the mortise of Left Leg Panel of Left Chair (C1).
Secure with Short Screws (①) to JRN Nut (③) with Screw Bit (⑤) and Allen key (④).

Turn in Screw for positioning of panels only.
LOOSELY TIGHTEN THE SCREWS, up to 80%.

Step 3

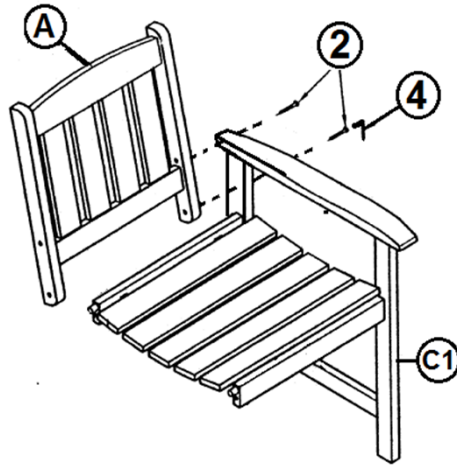

Insert each Tenon of Backrest Panel (A) to the mortise of Left Leg Panel of Left Chair (C1) .
Then attach this Panel (C1) to the Backrest Panel (A) with Long Screws (2) and Allen Key (4).
Turn in Screw for positioning of panels only.
LOOSELY TIGHTEN THE SCREWS, up to 80%.

Step 4

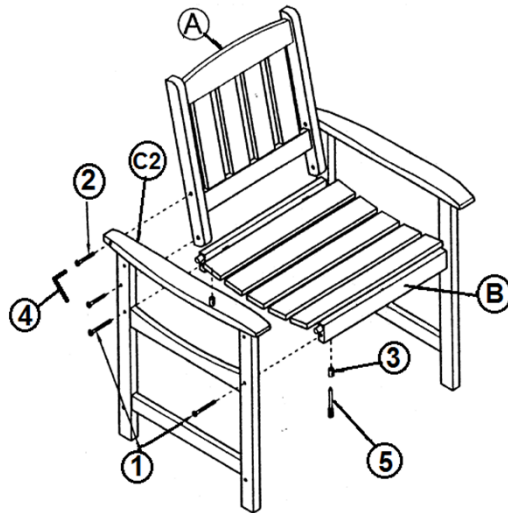

Insert tenon of Backrest Panel (A) and Seat Panel(B1) to the Right Leg Panel of Left Chair (C1).
Attach this Panel (C1) to the Backrest Panel (A) and Seat Panel (B) with Short & Long Screws (1 & 2) to JRN Nut (3) with Screw Bit (5) and Allen Key (4).
Turn in Screw for positioning of panels only.
TIGHTEN THE SCREWS, up to 80%.

Then, turn Chair to upright position.

Step 5

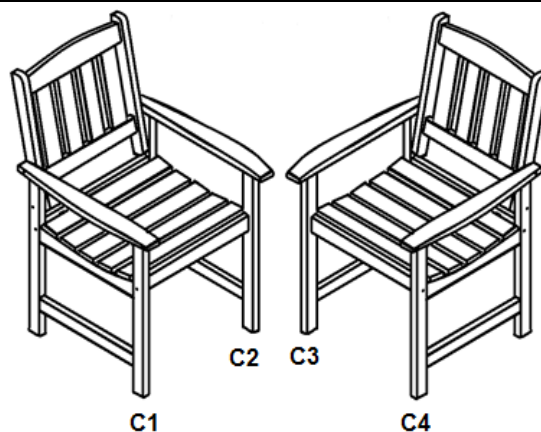

Repeat the above assembly step 2,3 and 4 to assemble the Right Chair.

Step 6

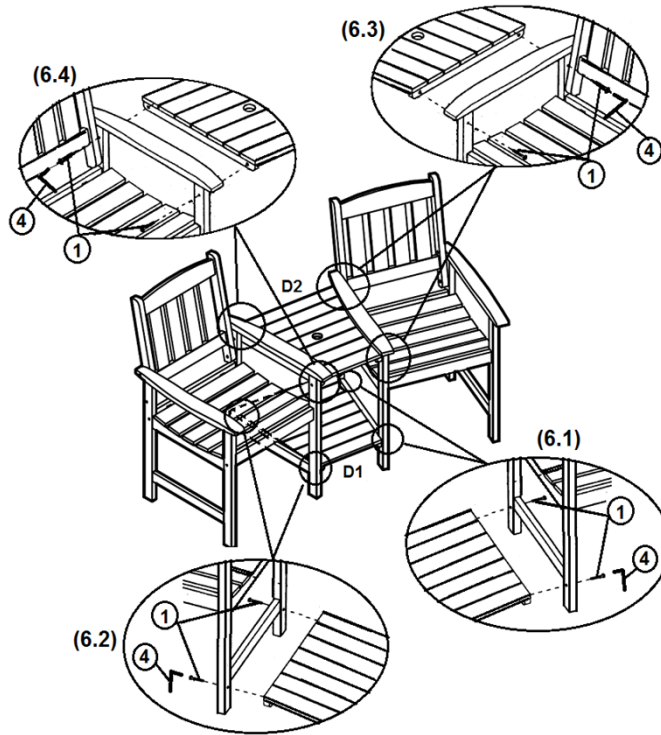

Caution : In this next remaining steps, to avoid injury to yourself and or damage to the goods, adults assistance may be needed to assist you in the remaining assembly process.

6.1 Place Shelf (D1) on the ground.

Then, position Chair Left and Chair Right to the long side of Shelf (D1).

6.2 Next, lift up Shelf (D1) and affix to the Leg panels of both Chair Left and Chair Right.

Affix by using Short Screw (①) & Allen Key (④).

LOOSELY TIGHT THE SCREWS.

6.3 Upon completion of attaching Shelf (D1) to the Loveseat, proceed to attach Table Top Shelf (D2).

6.4 Use the Short Screw (①) to secure Table Top Shelf (D2) and Table Bottom Shelf (D1) as shown in pictures above.

Step 7













Now that you have completed the position of Tray Tables in Step 6 above, proceed to **FULLY TIGHTEN** all Screws in a **SEQUENTIAL MANNER**.

TIGHTEN ALL SCREWS with the **ALLEN KEY**.

Inspect and make sure all parts are connected.

The Loveseat is ready for use

Care & Maintenance

-  ● Do not put hot items directly on furniture surface
 -  ● Do not clean furniture with harsh cleansers or polish.
 -  ● To obtain the longest lifespan of your outdoor products, minimizing exposure to direct sunlight is recommended.
 -  ● Children should not climb or jump on the furniture.
 -  ● Do not write on furniture without a padded barrier to protect the surface.
 -  ● To obtain the longest lifespan of your outdoor products, avoid extended and lengthy exposure to rain, snow, and direct sunshine. Whenever possible cover the product and /or place under patio or awnings.
 -  ● Not for commercial use. For residential use only .
 -  ● Stains may be removed with mild soap solution and damp cloth.
 -  ● Keep away from sources of ignition.
-
-  ● Dust and pick-up spills using a clean, non-colored, lint-free cloth.

Questions & Answers about Proposition 65

• What is Proposition 65?

Proposition 65 requires businesses to provide warnings to Californians about significant exposures to chemicals that cause cancer, birth defects or other reproductive harm.

These chemicals can be in the products that Californians purchase, in their homes or workplaces, or that are released into the environment. By requiring that this information be provided, Proposition 65 enables Californians to make informed decisions about their exposures to these chemicals.

Proposition 65 also prohibits California businesses from knowingly discharging significant amounts of listed chemicals into sources of drinking water.

Proposition 65 requires California to publish a list of chemicals known to cause cancer, birth defects or other reproductive harm. This list, which must be updated at least once a year, has grown to include approximately 900 chemicals since it was first published in 1987.

• What types of chemicals are on the Proposition 65 list?

The list contains a wide range of naturally occurring and synthetic chemicals that include additives or ingredients in pesticides, common household products, food, drugs, dyes, or solvents. Listed chemicals may also be used in manufacturing and construction, or they may be byproducts of chemical processes, such as motor vehicle exhaust.

• What does a warning mean?

If a warning is placed on a product label or posted or distributed at a workplace, a business, or in rental housing, the business issuing the warning is aware or believes that it is exposing individuals to one or more listed chemicals.

By law, a warning must be given for listed chemicals unless the exposure is low enough to pose no significant risk of cancer or is significantly below levels observed to cause birth defects or other reproductive harm.

• Where can I get more information on Proposition 65?

If you have specific questions on the administration or implementation of Proposition 65, you can contact OEHHA's Proposition 65 program at P65.Questions@oehha.ca.gov, or by phone at (916) 445-6900.