

PRODUCT FEATURES

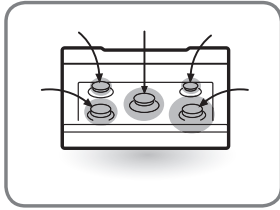

Multiple Gas Burner Sizes

Choose a burner to fit the size of the cookware.

Cooking multiple items at once is possible by using different burners at the same time.



Safe and Convenient Gas Range

Provides safety and convenience for cooking.

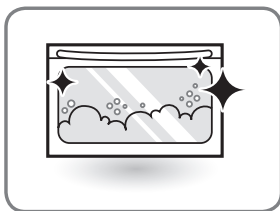

Self Clean & EasyClean®

Useful for easy cleaning.

IMPORTANT SAFETY INSTRUCTIONS

Read and follow all instructions when using the range to prevent the risk of fire, electric shock, personal injury, or damage. This guide does not cover all possible conditions that may occur. Always contact your service agent or manufacturer about problems that you do not understand.

Download this owner's manual at: <http://www.lg.com>



This is the safety alert symbol. This symbol alerts you to potential hazards that can result in property damage and/or serious bodily harm or death.

All safety messages will follow the safety alert symbol and either the word WARNING or CAUTION. These words mean:



WARNING - Indicates a hazardous situation which, if not avoided, could result in death or serious injury.



CAUTION - Indicates a hazardous situation which, if not avoided, could result in minor or moderate injury.

ANTI-TIP DEVICE



WARNING

- ALL RANGES CAN TIP
 - INJURY TO PERSONS COULD RESULT
 - INSTALL ANTI-TIP DEVICES PACKED WITH RANGE
 - SEE INSTALLATION INSTRUCTIONS
 - A child or adult can tip the range and be killed.
 - Install the anti-tip device to the structure and/or the range. Verify the anti-tip device has been properly installed and engaged by following the guide of the Anti tip bracket template.
 - Engage the range to the anti-tip device by following the guide of the Anti tip bracket template. Ensure the anti-tip device is re-engaged when the range is moved by following the guide of the Anti tip bracket template.
 - Re-engage the anti-tip device if the range is moved. Do not operate the range without the anti-tip device in place and engaged.
 - See installation instructions for details.
 - Failure to do so can result in death or serious burns to children or adults.
- To avoid tipping, do not step or sit on the door. Install the anti-tip bracket packed with this range.
 - The range could be tipped and injury might result from spilled hot liquid, food, or the range itself.
 - If the range is pulled away from the wall for cleaning, service, or any other reason, ensure that the anti-tip device is properly reengaged when the range is pushed back against the wall.

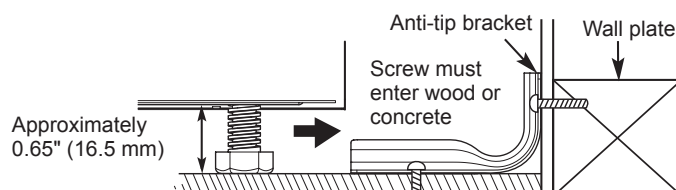

- To reduce the risk of the range tipping over, the range must be secured by properly installing the anti-tip device.
- To check that the anti-tip bracket is properly installed: Remove any items on the cooktop. Grasp the top rear edge of the range back guard and carefully attempt to tilt it forward. Verify that the anti-tip device is engaged.
- Remove the warming or storage drawers and visually inspect that the rear leveling leg is fully inserted into the anti-tip bracket.
- Refer to the installation section of the manual for proper anti-tip bracket installation.

IMPORTANT SAFETY NOTICE

Gas appliances can cause minor exposure to four of these substances, namely benzene, carbon monoxide, formaldehyde and soot, caused primarily by the imperfect combustion of natural or LP gas. Correctly adjusted burners, indicated by a bluish rather than a yellow flame, will minimize imperfect combustion. Exposure to these substances can be minimized by opening windows or using a ventilation fan or hood.

WARNING

- Never use your range as a space heater to heat or warm the room. Doing so may result in carbon monoxide poisoning and overheating of the oven.
- Never wear loose fitting or hanging garments while using the appliance. Be careful when reaching for items placed in cabinets over the range. Flammable materials could be ignited if brought in contact with flame or hot oven surfaces and may cause severe burns.
- Do not place or use combustible materials such as gasoline or other flammable vapors and liquids in the vicinity of this or any other appliance.
- Do not place flammable materials in the oven or near the cooktop.
- Do not allow cooking grease or other flammable materials in or near the range.
- Do not use water on grease fires. Never touch a flaming pan. Turn the controls off. Smother a flaming pan on a surface burner by covering the pan completely with a well-fitting lid, cookie sheet or flat tray. Use a multi-purpose dry chemical or foam-type fire extinguisher.
A grease fire can be put out by covering it with baking soda or, if available, by using a multi-purpose dry chemical or foam-type fire extinguisher.
Flame in the oven or the drawer can be smothered completely by closing the oven door or drawer and turning the control to off or by using a multi-purpose dry chemical or foam-type fire extinguisher.
- Do not use the oven or the drawer for storage.
- Let the burner grates and other surfaces cool before touching them.
- Never block the vents (air holes) of the range. They provide the air inlet and outlet necessary for the range to operate properly with correct combustion. Air openings are located at the rear of the cooktop, at the top and bottom of the oven door, and at the bottom of the range.
- Never obstruct the flow of combustion and ventilation air by blocking the oven vent or air intakes. Doing so restricts air to the burner and may result in carbon monoxide poisoning.

 **WARNING**

- Never cover any slots, holes or passages in the oven bottom or cover an entire rack with materials such as aluminum foil. Doing so blocks air flow through the oven and may cause carbon monoxide poisoning. Aluminum foil linings may also trap heat, causing a fire hazard.
- Large scratches or impacts to glass doors can lead to broken or shattered glass.
- Stepping, leaning or sitting on the doors or drawers of this range can result in serious injuries and also cause damage to the range. Do not allow children to climb or play around the range. The weight of a child on an open door may cause the range to tip, resulting in serious burns or other injury.
- Leak testing of the appliance must be conducted according to the manufacturer's instructions.
- Gas leaks may occur in the system and result in a serious hazard. Gas leaks may not be detected by smell alone. Gas suppliers recommend you purchase and install a UL-approved gas detector. Install and use in accordance with the gas detector manufacturer's instructions.
- Do not use commercial oven cleaners on the oven finish or around any part of the oven. They will damage the finish.
- To prevent staining or discoloration, clean appliance after each use.
- Do not attempt to open or close the door or operate the oven until the door is properly installed.
- Never place fingers between the hinge and front oven frame. Hinge arms are spring mounted. If accidentally hit, the hinge will slam shut against the oven frame and injure fingers.

 **CAUTION**

- Items of interest to children should not be placed in cabinets above the range or on the backsplash of the range - children climbing on the range to reach items could be seriously injured.
- Do not leave children alone or unattended where a range is hot or in operation. They could be seriously burned.
- Do not let anyone climb, stand or hang on the oven door, warming drawer or cooktop. They could damage the range or tip it over, causing severe personal injury.
- Wear gloves when cleaning the range to avoid injury or burns.
- Do not use the oven for storing food or cookware.
- To prevent damage to the oven door, do not attempt to open the door when Lock is displayed.
- Do not stand or place excessive weight on an open door. This could tip the range, break the door, or injure the user.
- Do not use delayed baking for highly perishable foods such as dairy products, pork, poultry, or seafood.

INSTALLATION SAFETY PRECAUTIONS

Have the installer show you the location of the range gas shut-off valve and how to shut it off if necessary.

WARNING

- Make sure your range is properly installed and grounded by a qualified installer, according to the installation instructions. Any adjustment and service should be performed only by qualified gas range installers or service technicians.
- Make sure your range is properly adjusted by a qualified service technician or installer for the type of gas (natural or LP) that is to be used. The range can be converted for use with either type of gas. See the installation instructions.
- These adjustments must be done by a qualified service technician according to the manufacturer's instructions and all codes and requirements of the authority having jurisdiction. Failure to follow these instructions could result in serious injury or property damage. The qualified agency performing these adjustments assumes responsibility for the conversion.
- Disconnect the electrical supply before servicing the appliance.
- Never use the appliance door as a step stool or seat, as this may result in possible tipping of the appliance and serious injuries.
- This product should not be installed below ventilation type hood systems that direct air in a downward direction.
Doing so may cause ignition and combustion problems with the gas burners resulting in personal injury and may affect the cooking performance of the unit.
- Plug your range into a 120-volt grounded outlet only. Do not remove the round grounding prong from the plug. If in doubt about the grounding of the home electrical system, it is your personal responsibility and obligation to have an ungrounded outlet replaced with a properly grounded, three-prong outlet in accordance with the National Electrical Code. Do not use an extension cord with this range.
- To prevent fire hazard or electrical shock, do not use an adapter plug, an extension cord, or remove the grounding prong from the electrical power cord. Failure to follow this warning can cause serious injury, fire or death.
- To prevent poor air circulation, place the range out of the kitchen traffic path and out of drafty locations.
- Do not attempt to repair or replace any part of the range unless it is specifically mentioned in this manual. All other services should be referred to a qualified technician.
- Make sure that all packaging materials are removed from the range before operating it to prevent fire or smoke damage should the packaging material ignite.

⚠ WARNING

- To shut off the gas supply to the range, close the range gas shutoff valve by turning it clockwise.

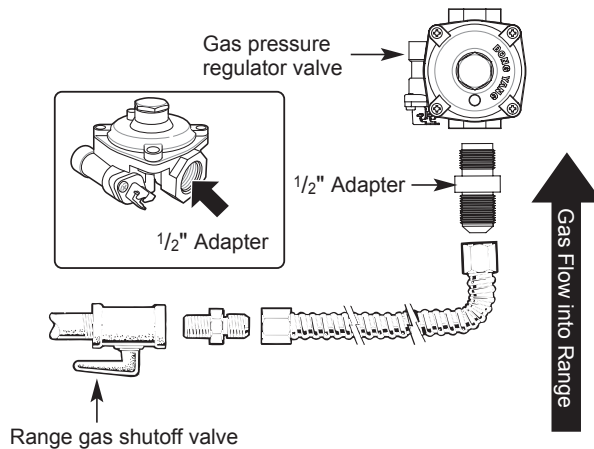

Installer: Inform the consumer of the location of the gas shut-off valve.

- After using the range for an extended period of time high floor temperatures may result. Many floor coverings will not withstand this kind of use.
- Never install the range over vinyl tile or linoleum that cannot withstand such type of use. Never install it directly over interior kitchen carpeting.

SURFACE BURNERS

⚠ WARNING

- Even if the top burner flame goes out, gas is still flowing to the burner until the knob is turned to the **Off** position. If you smell gas, immediately open a window and ventilate the area for five minutes prior to using the burner. Do not leave the burners on unattended.
- **Use proper pan size.** Do not use pans that are unstable or that can be easily tipped. Select cookware with flat bottoms large enough to cover burner grates. To avoid spillovers, make sure the cookware is large enough to contain the food properly. This will both save cleaning time and prevent hazardous accumulations of food, since heavy spattering or spillovers left on the range can ignite. Use pans with handles that can be easily grasped and remain cool.

 **CAUTION**

- Be sure that all surface controls are set in the **Off** position prior to supplying gas to the range.
- Never leave the surface burners unattended at high flame settings. Boilovers may cause smoke and greasy spillovers that may ignite.
- Always turn the knobs to the **Lite** position when igniting the top burners and make sure the burners have ignited.
- Control the top burner flame size so it does not extend beyond the edge of the cookware. Excessive flame is hazardous.
- Only use dry pot holders- moist or damp pot holders on hot surfaces may result in burns from steam. Do not let pot holders come near open flames when lifting cookware. Do not use towels or other bulky cloth items. Use a pot holder.
- If using glass cookware, make sure the cookware is designed for range-top cooking.
- To prevent burns from ignition of flammable materials and spillage, turn cookware handles toward the side or back of the range without extending them over adjacent burners.
- Never leave any items on the cooktop. The hot air from the vent may ignite flammable items and will increase pressure in closed containers, which may cause them to burst.
- Carefully watch foods being fried at a high flame setting.
- Always heat fat slowly, and watch as it heats.
- If frying combinations of oils and fats, stir together before heating.
- Use a deep fat thermometer if possible to prevent overheating fat from heating beyond the smoking point.
- Use the least possible amount of fat for effective shallow or deep fat frying. Filling the pan with too much fat can cause spillovers when food is added.
- Do not cook foods directly on an open flame on the cooktop.
- Do not use a wok on the surface burners if the wok has a round metal ring that is placed over the burner grate to support the wok. This ring acts as a heat trap, which may damage the burner grate and burner head. It may also cause the burner to work improperly. This may cause carbon monoxide levels which are higher than what is allowed by current standards, resulting in a health hazard.
- Foods for frying should be as dry as possible. Frost or moisture on foods can cause hot fat to bubble up and spill over the sides of the pan.
- Never try to move a pan of hot fat, especially a deep fryer. Wait until the fat is cool.
- Do not place plastic items on the cooktop- they may melt if left too close to the vent.
- Keep all plastics away from the surface burners.
- To prevent burns, always be sure that the controls for all burners are in the **Off** position and all grates are cool before attempting to remove them.
- If you smell gas, turn off the gas to the range and call a qualified service technician. Never use an open flame to locate a leak.
- Always turn the knobs to the **Off** position before removing cookware.
- Do not lift the cooktop. Lifting the cooktop can cause damage and improper operation of the range.
- If the range is located near a window, do not hang long curtains that could blow over the surface burners and catch on fire.
- Use care when cleaning the cooktop. The pointed metal ends on the electrodes could cause injury.

BROILER

Always use a broiler pan and a grid for excess fat and grease drainage. This will help to reduce splatter, smoke, and flare-ups.

WARNING

When using the broiler, the temperature inside the oven will be extremely high. Take caution to avoid possible burns by:

- Keeping the door closed when broiling (refer to Broil section of the manual)
- Always wearing oven mitts when inserting or removing food items

COOK MEAT AND POULTRY THOROUGHLY

To protect against food-borne illnesses, cook meat and poultry thoroughly—ground beef to at least an INTERNAL temperature of 160 °F, poultry to at least an INTERNAL temperature of 165 °F and beef, pork, veal & lamb steaks & chops to at least an INTERNAL temperature of 145 °F.

SELF CLEANING OVEN

Make sure to wipe off excess spillage before operating the self clean function.

CAUTION

- Do not leave food, cooking utensils, racks, etc. in the oven during the self clean cycle.
- Do not use oven cleaners. No commercial oven cleaner or oven liner protective coating of any kind should be used in or around any part of the oven. Residue from oven cleaners will damage the inside of the oven when the self clean cycle is used.
- Remove oven racks and other items from both upper and lower ovens before starting the self clean cycle.
- Only clean the parts listed in this manual.
- Do not clean the door gasket. The door gasket is necessary for a good seal. Care should be taken not to rub, damage or move the gasket.
- If the self cleaning mode malfunctions, turn the range off and disconnect the power supply. Have the range serviced by a qualified technician.
- It is normal for parts of the oven to become hot during a self clean cycle.
- Avoid touching the door, window or oven vent area during a clean cycle.

OVEN

When opening the door of a hot oven, stand away from the range. The hot air and steam that escape can cause burns to hands, face and eyes.

WARNING

- Never block any slots, holes or passages in the oven bottom or cover an entire rack with materials such as aluminum foil. Doing so blocks air flow through the oven and may cause carbon monoxide poisoning. Aluminum foil linings may trap heat, causing a fire hazard.
- Do not heat food in closed containers. Pressure inside the container could increase and cause the container to burst, resulting in injury.

⚠ WARNING

- Do not line oven walls or bottom with aluminum foil or allow them to contact exposed heating elements in the oven. Doing so could create a fire hazard or cause damage to the range.
- Do not use the oven for storage. Items stored in the oven can catch on fire.
- Keep the oven free from grease buildup.
- Insert the oven racks in the desired position while the oven is cool.
- To prevent burns when removing food, slide racks out until the stop engages, then remove food items. This may also protect you from getting burnt by touching hot surfaces of the door or oven walls.
- When placing or removing a griddle, always wear oven mitts.
- When using cooking or roasting bags in the oven, follow the manufacturer's directions.
- Use only glass cookware that is recommended for use in gas ovens.
- Always remove the broiler pan from the range after you finish broiling. Grease left in the pan can catch fire if the oven is used without removing the grease from the broiler pan.
- If meat is too close to the flame while broiling, the fat may ignite. Trim excess fat to prevent excessive flare-ups.
- Make sure the broiler pan is in place correctly to minimize the possibility of grease fires.
- If you have a grease fire in the broiler pan, press the **Clear/Off** and keep the oven door closed to contain the fire until it burns out.
- For safety and better cooking performance, always bake and broil with the oven door closed. Open door baking or broiling can cause damage to the knobs or valves. Do not leave the oven door open during cooking or while the oven is cooling down.

ENERGY SAVING TIPS

- Multiple-rack cooking saves time and energy. Whenever possible, cook foods requiring the same cooking temperature together in one oven.
- For optimal performance and energy savings, follow the guides on page 29 for proper rack and pan placements.
- Match the size of the cookware to the amount of food being cooked to save energy when heating. Heating ½ quart of water requires more energy in a 3-quart pot than in a 1-quart pot.
- Use cookware with flat bottoms to provide the best contact with the cooktop surface when cooking on the glass-ceramic cooktop.
- Match the size of the cooktop burner or element to the size of the cookware in use. Using a large element for a small pan wastes heating energy, and the exposed surface of the element is a burn or fire hazard.
- Reduce energy use by cleaning light oven soils with the EasyClean® feature instead of self-clean.
- Avoid opening the oven door more than necessary during use. This helps the oven maintain temperature, prevents unnecessary heat loss, and saves on energy use.

Read all instructions before using the appliance.

SAVE THESE INSTRUCTIONS

PRODUCT OVERVIEW

Parts

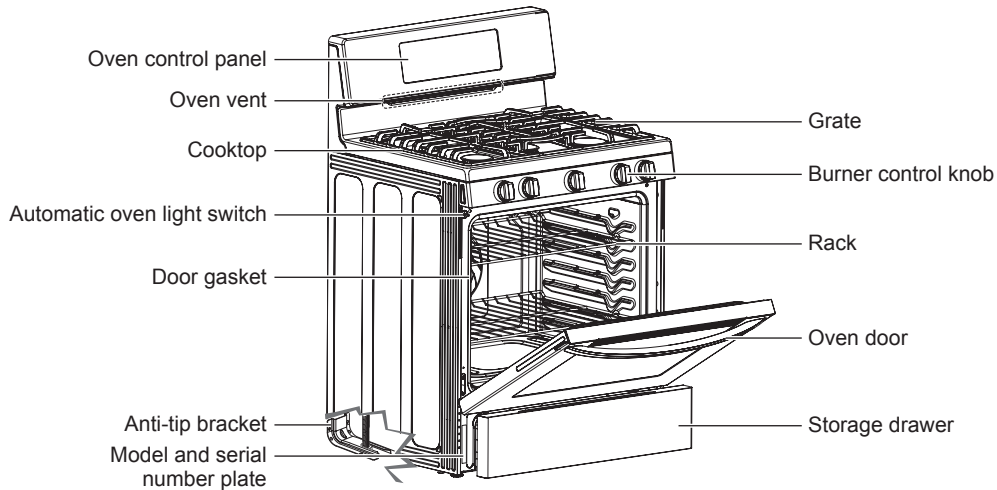

Accessories

Included Accessories



Standard rack (2ea)



Griddle (1ea)
(LRG3061, LRG3193,
LRG3194)



Owner's manual (1ea)

Anti-tip kit

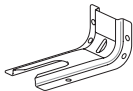

Anti-tip (1ea)



Screws (4ea)



Anchors (4ea)

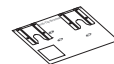

Template (1ea)

LP nozzle conversion kit

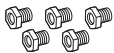

Cooktop Nozzles (5ea)



Oven Nozzles (2ea)



Choke (1ea)



Set screw (1ea)

EasyClean® kit (LRG3061, LRG3193)



Spray bottle (1ea)

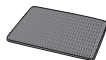

Non-scratch scouring pad (1ea)

Optional Accessories

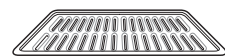

Grid



Broiler pan

NOTE

- Contact LG Customer Service at 1-800-243-0000 (1-888-542-2623 in Canada) if any accessories are missing.
- For your safety and for extended product life, only use authorized components.
- The manufacturer is not responsible for product malfunction or accidents caused by the use of separately purchased, unauthorized components or parts.
- The images in this guide may be different from the actual components and accessories, which are subject to change by the manufacturer without prior notice for product improvement purposes.