

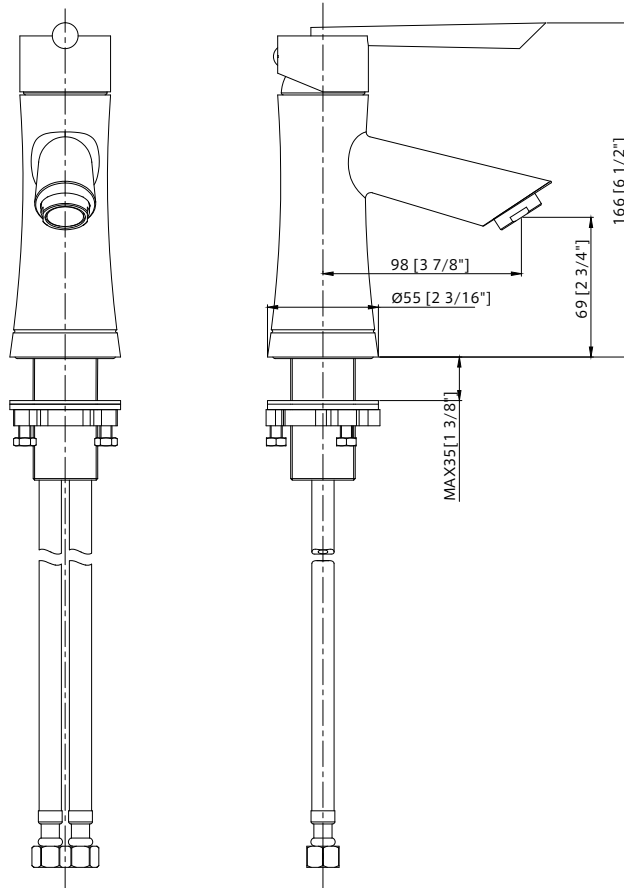

Single-handle Bathroom Sink Faucet

81H11-***



Technical Information

All product dimensions are nominal.

Valve body: Lead free brass

Drain included: NO

Spout

Spout Length: 3-3/8"

Spout Height: 2-3/4"

Faucet

Flow rate: 1.5 gal/min (5.7 l/min)

Pressure: 60 psi (4.1 bar)

Installation Information

Install this product according to the installation instructions.

Faucet Lifetime Limited Warranty

See website for detailed warranty information.

Italia Faucets, Inc.
2505 Anthem Village Dr, Suite E-240
Henderson, NV 89052
(877) 482-5422
For the most current Specification Sheet, go to : www.italiafaucets.com





Single-handle Bathroom Sink Faucet

81H11-***

Features

- Single lever handle allows for both on/off activation,
- Ceramic disc valves exceed industry longevity standards for a lifetime of durable performance.
- 1.5 gal/min (5.7 l/min) maximum flow rate [max at 60 psi (4.1 bar)]
- Red/blue indexing on handle.
- Flexible supplies for simplified installation.

Material

- Premium metal construction.
- Finishing resists corrosion and tarnishing.



Installation

- Single-hole.



NSF/ANSI 61



Codes/Standards

- CUPC (ASME A112.18.1-2012/CSA B125.1-12)
- NSF/ANSI 61
- NSF/ANSI 372
- All applicable US Federal and State material regulations
- EPA WaterSense®
- CEC (California Energy Commission)

Available Color/Finishes

Intended for reference only.

Color	Code	Description
	CHR	Chrome
	BN	Brush Nickel
	ORB	Oil Rubbed Bronze
	MB	Matte Black

Italia Faucets, Inc.
 2505 Anthem Village Dr, Suite E-240
 Henderson, NV 89052
 (877) 482-5422
 For the most current Specification Sheet, go to : www.italiafaucets.com

