



DUAL FUEL



XP2200IS GENERATOR

User Manual

REV: XP2200iS-03262018

This manual provides information regarding the operation and maintenance of these products. We have made every effort to ensure the accuracy of the information in this manual. We reserve the right to change this product at any time without prior notice.

5800 Ontario Mills Pkwy
Ontario, CA 91764 USA
www.duromaxpower.com

Call our Customer Care Team Toll Free 8-5pm PST Mon-Fri
844-DUROMAX



CONTENTS

1.

Introduction

| | |
|------------------------------------|----|
| Introduction | 6 |
| General Safety Procedures | 7 |
| Quick Start Guide (Gasoline) | 10 |
| Generator Components | 12 |
| Package Contents | 14 |

2.

Generator Setup

| | |
|-------------------------------|----|
| Adding Oil | 16 |
| Adding Gasoline | 17 |
| Grounding the Generator | 18 |
| High Altitude Operation | 18 |

3.

Starting the Generator

| | |
|------------------------------|----|
| Checking the Oil | 20 |
| Check the Gas Level | 21 |
| Starting the Generator | 22 |

4.

Using the Generator

| | |
|--|----|
| AC Usage | 26 |
| Connecting a Load to the Generator | 28 |
| Parallel Usage | 30 |
| USB Usage | 32 |
| 12V Auto Usage | 33 |

CONTENTS

| | | |
|-----------|----------------------------------|----|
| 5. | Maintenance and Care | |
| | Maintenance Schedule..... | 36 |
| | Maintenance Log | 37 |
| | Checking the Oil | 38 |
| | Changing the Oil..... | 39 |
| | Cleaning the Air Filter | 40 |
| | Spark Plug Maintenance | 42 |
| | Storage and Transportation | 44 |
| | Specifications..... | 45 |
| 6. | Troubleshooting | |
| | Basic Troubleshooting | 48 |
| 7. | Warranty | 50 |
| 8. | Contact Information | 54 |



INTRODUCTION

DuroMax has cemented its reputation as one of the markets leading power equipment companies who are headquartered in the US. All of our products are manufactured to the strictest guidelines and go through countless testing in all phases of production.

Evolving our strong engine line, DuroMax has complemented its offerings to include Pressure Washers, Water Pumps, Engines and now offering V-Twin engines. Reliability is the highest standard we hold ourselves to, whether its powering a heater during a winter storm that knocks out power, dewatering a flooded property, or washing away a deck for the summer season



Notice Regarding Emissions

Engines that are certified to comply with U.S. EPA emission regulations for SORE (Small off Road Equipment), are certified to operate on regular unleaded gasoline, and may include the following emission control systems: (EM) Engine Modifications and (TWC) Three-Way Catalyst (if so equipped).

GENERAL SAFETY PROCEDURES



SAFETY ALERT SYMBOL

The safety alert symbol is used with one of the safety words (**DANGER**, **CAUTION**, or **WARNING**) to alert you of hazards. Please pay attention to these hazard notices both in this manual and on the generator.

Please familiarize yourself with the following safety symbols and words:

- **DANGER:** Indicates a hazard that will result in serious injury or death if instructions are not followed.
- **WARNING:** Indicates a strong possibility of causing serious injury or death if instructions are not followed.
- **CAUTION:** Indicates a possibility of personal injury or equipment damage if instructions are not followed.



DANGER: This generator produces poisonous carbon monoxide gas when running. This gas is both odorless and colorless. Even if you do not see or smell gas, carbon monoxide may still be present. Breathing this poison can lead to headaches, dizziness, drowsiness, and eventually death.

- Use outdoors **ONLY** in non-confined areas.
- Keep several feet of clearance on all sides to allow proper ventilation of the generator.



WARNING: The exhaust from this product contains chemicals known to the State of California to cause cancer, birth defects, or other reproductive harm.



WARNING: This generator produces heat when running. Temperatures near exhaust can exceed 150°F (65°C).

- Do not touch hot surfaces. Pay attention to warning labels on the generator denoting hot parts of the machine.
- Allow generator to cool several minutes after use before touching engine or areas which heat during use.

GENERAL SAFETY PROCEDURES



WARNING: This generator may emit highly flammable and explosive gasoline vapors, which can cause severe burns or even death. A nearby open flame can lead to an explosion even if not directly in contact with gas.

- Do not operate near an open flame.
- Do not smoke near generator.
- Always operate on a firm, level surface.
- Always turn generator off before refueling.
- Allow generator to cool for at least 2 minutes before removing fuel cap. Loosen cap slowly to relieve pressure in tank.
- Do not overfill gas tank. Gas may expand during operation. Do not fill to the top of the tank.
- Always check for spilled gas before operating.
- Empty the gasoline tank before storing or transporting the generator.
- Before transporting, turn fuel valve to the off position and disconnect the spark plug.



WARNING: This generator produces a powerful voltage, which can result in electrocution.

- ALWAYS ground the generator before using it (see the “Grounding the Generator” portion of the “PREPARING THE GENERATOR FOR USE section).
- Generator should only be plugged into electrical devices, either directly or with an extension cord. NEVER connect to a building electrical system without a qualified electrician. Such connections must comply with local electrical laws and codes. Failure to comply can create a backflow of power, which may result in serious injury or death to utility workers.
- Use a ground fault circuit interrupter (GFCI) in highly conductive areas such as metal decking or steel work. GFCIs are available in-line with some extension cords.
- Do not use uncovered in rainy or wet conditions.
- Do not touch bare wires or receptacles (outlets).
- Do not allow children or non-qualified persons to operate.

GENERAL SAFETY PROCEDURES

In addition to the above safety notices, please familiarize yourself with the safety and hazard markings on the generator.



⚠ DANGER

Using a generator indoors **CAN KILL YOU IN MINUTES**. Generator exhaust contains carbon monoxide. This is a poison you cannot see or smell.

| | | |
|---|--|--|
| | | |
| NEVER use inside a home or garage, EVEN IF doors and windows are open. | | Only use OUTSIDE and far away from windows, doors, and vents. |

⚠ DANGER

| | | | | | |
|--|---|--|---|-------------------------------|---|
| | Failure to read and follow the instructions in user manual(s) could result in death, bodily injury, and/or property damage. | | Generator is a potential source of electric shock. Do not expose to moisture, rain, or snow. Do not operate with wet hands or feet. | | Gasoline and its vapors are flammable and explosive. Turn engine off and let it cool at least 2 minutes before refueling. |
| | Running engines give off carbon monoxide, an odorless, colorless, poisonous gas. Breathing carbon monoxide can cause nausea, fainting or death. DO NOT run in enclosed area, even if windows and doors are open. | | Failure to properly ground generator can result in electrocution, especially if the generator is equipped with a wheel kit. | DO NOT REMOVE THIS TAG | |



HOT

⚠ CAUTION

QUICK START GUIDE



1. Open access panel

Using a Phillips screwdriver (not included) unscrew the top screw in the access panel and remove the panel.



2. Add oil

The oil fill cap is located on the lower engine block on the right inside the access panel. Remove the oil fill cap and fill with 10w30 oil. Close the access panel when finished.



3. Add gasoline

The fuel cap is located on top of the generator. Fill the tank with fresh unleaded gasoline 87 octane or higher.

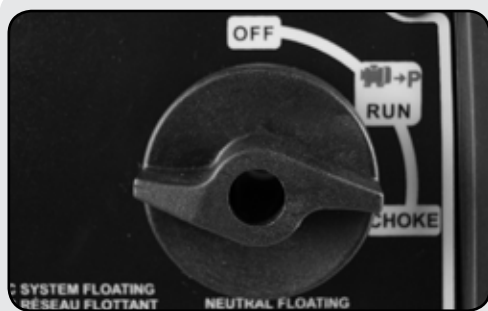

4. Switch start selector to Choke

Turn the Start Switch knob to Choke.



5. Turn gas valve on

The gas valve is located on the gas cap. Rotate the valve counter clockwise to the ON position.

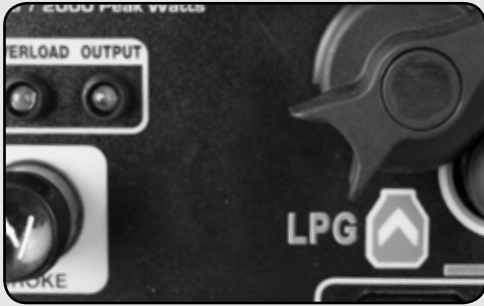

6. Turn eco mode off

The gas valve is located above the recoil start on the bottom of the fuel tank. Rotate the valve counter clockwise to the horizontal position to stop the flow of gasoline to the carburetor.



9. Pull recoil

Pull the recoil start handle briskly. It may take 2 to 3 pulls to the unit to start.

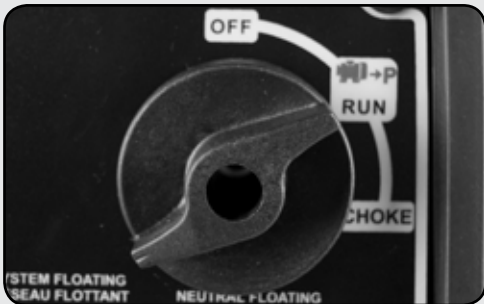

10. Switch start selector to Run

Turn the Start Switch knob to Run.

GENERATOR COMPONENTS



1. **Fuel Valve** - Open to allow gasoline into the engine, close to transport.
2. **Fuel Cap** - Allows access to fill the gasoline tank.
3. **Muffler** - Reduces engine emissions and reduces noise.
4. **Recoil Start** - Easy Pull Recoil Start to start the engine.
5. **Output Light** - Lit when the unit is producing power.
6. **Overload Light** - Blinks when the unit is in surge mode, lit steady when overloaded.
7. **Low Oil Light** - Lit when the unit shuts down, or will not start, due to low oil.
8. **12V Auto Outlet** - Used to power 12v automotive style appliances and tools.
9. **Eco Mode Switch** - Slows the engine speed when demand on the generator is low.

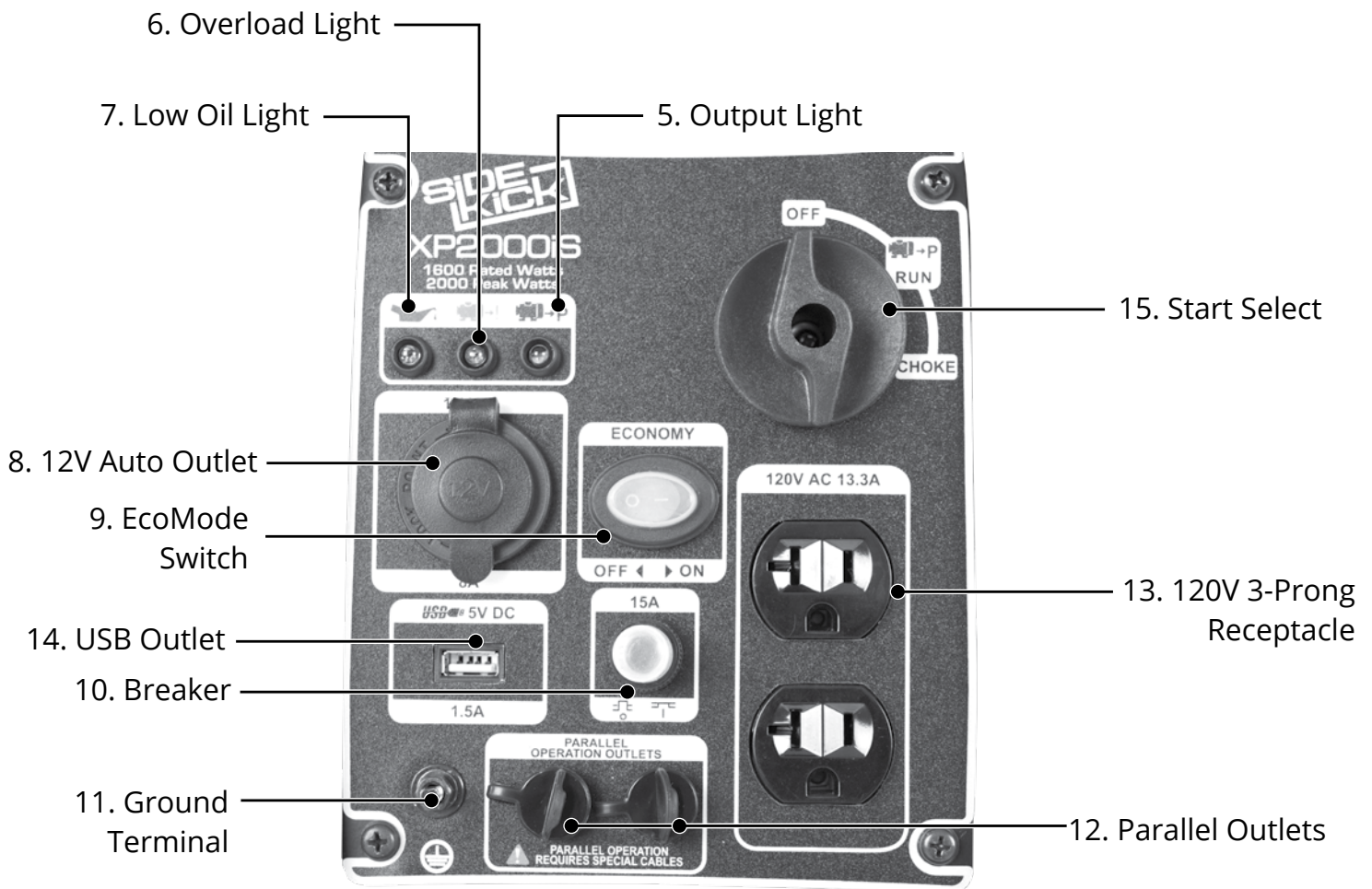

- 10. **Breaker** - Prevents overloads from damaging equipment and the generator.
- 11. **Ground Terminal** - Connect a ground wire here to properly ground the generator.
- 12. **Parallel Outlets** - Allows use of two units parallel to handle large loads. ***Parallel Kit Sold separately**
- 13. **120v 3-Prong Receptacle** - Use to connect electrical devices that run 120 Volt, 60 Hz, single phase, AC current (NEMA 5-20).
- 14. **USB Outlet** - Used to charge phones, tablets, and any other USB powered electronics.
- 15. **Start Select** - Used to start or stop the generator.

PACKAGE CONTENTS

Your generator comes with the items listed below. Please check to see that all of the following items are included with your generator.



Spark Plug Wrench

Used in spark plug maintenance, inspection, and installation.



Oil Funnel w/ hose

Used to add oil to the generator without messy spills.

- Note: Actual tools may differ in appearance or design from image shown.



GENERATOR SETUP

Proper setup of your generator will get you going as soon as possible while making sure you and your equipment are safe and cared for.

GENERATOR SETUP

Step 3 - Adding Oil

The generator requires engine oil to operate properly. The generator, when new from the package contains no oil in the crankcase*. You must add the proper amount of oil before operating the generator for the first time. This amount is equal to the oil capacity of the engine crankcase:

| | |
|----------------------------|---------------------|
| Model Number | XP2200iS |
| Engine Oil Capacity | 11.8 fl. oz (0.35L) |

WARNING: Do not apply engine oils with additives or 2-stroke gasoline engine oils. They don't have enough lubrication, and may shorten the engine's service life.

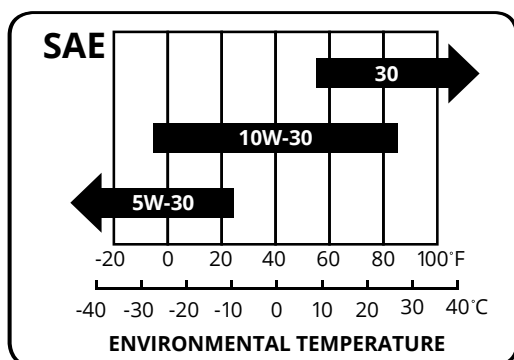

Engine oil recommended: SAE 10W-30. Viscosity varies with regions and temperatures. Choose your oil viscosity using the chart to the left.

* A small amount of oil from factory testing may be present on arrival.



1. Add oil

- Make sure the generator is on a level surface.
- Unscrew the oil filler/dipstick cap from the engine .
- Using a funnel, add the appropriate amount of oil into the crankcase. You will know the crankcase is full when the oil level has reached the lower lip of the opening you have just poured the oil into.
- Replace oil filler cap.

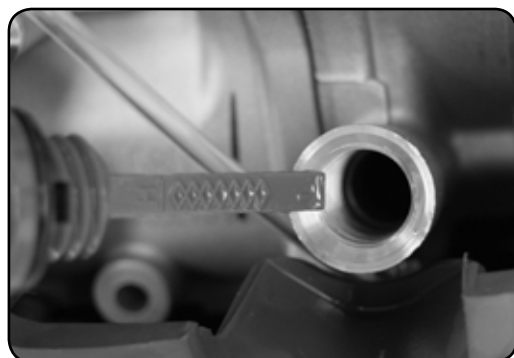

WARNING: DO NOT overfill the crankcase. This may damage the motor and shorting overall life of your generator.

Step 4 - Adding Gasoline



WARNING: Gasoline and gas fumes are highly flammable.

- Do not fill tank near an open flame.
- Do not overfill. Always check for fuel spills.

To ensure that the generator runs smoothly use only FRESH, UNLEADED GAS WITH AN OCTANE RATING OF 87 OR HIGHER.



2. Add Gasoline

- Make sure the generator is on a level surface.
- Unscrew gas cap and set aside (NOTE: the gas cap may be tight and hard to unscrew).
- Slowly add unleaded gasoline to the fuel tank. Be careful not to overfill. Please refer to the chart below to find the gas capacity of your generator model.
- Replace fuel cap and wipe up any spilled gasoline with a dry cloth.

NOTE: Gas can expand. Do not fill the gas tank to the very top. Leave a minimum of 1.5 in of open space.



IMPORTANT:

- Never use an oil/gasoline mixture. Never use old gas.
- Avoid getting dirt or water in the fuel tank.
- Gas can age in the tank and make it hard to start up the generator in the future.
- Never store generator for extended periods of time with fuel in the tank.

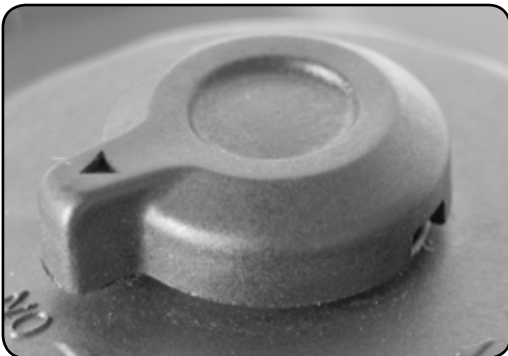

| | |
|--------------------------|------------------------|
| Model Number | XP2200iS |
| Gas Tank Capacity | 1.18 US Gallons (4.5L) |

GENERATOR SETUP (CONTINUED)

Step 5 - Grounding the Generator



1. Attach grounding wire

- a. Ground the generator by tightening the grounding nut against a grounding wire.
- b. Connect the other end to a copper or brass grounding rod that's driven into the earth.

A generally acceptable grounding wire is a No. 12 AWG (American Wire Gauge) stranded copper wire.



Grounding codes can vary by location. Please contact a local electrician to check the grounding regulations for your area.



WARNING: Failure to properly ground the generator can result in electrocution.

High Altitude Operation

At high altitude, the standard carburetor air/fuel mixture will be too rich. Performance will decrease, and fuel consumption will increase. A very rich mixture will also foul the spark plug and cause hard starting. Operation at an altitude that differs from that at which this engine was certified, for extended periods of time, may increase emissions. High altitude performance can be improved by specific modifications to the carburetor. If you always operate your generator at altitudes above 5,000 feet (1,500 meters), have a dealer perform this carburetor modification. This engine, when operated at high altitude with the carburetor modifications for high altitude use, will meet each emission standard throughout its useful life. Even with carburetor modification, engine horsepower will decrease about 3.5% for each 1,000-foot (300-meter) increase in altitude. The effect of altitude on horsepower will be greater than this if no carburetor modification is made.

When the carburetor has been modified for high altitude operation, the air/fuel mixture will be too lean for low altitude use. Operation at altitudes below 5,000 feet (1,500 meters) with a modified carburetor may cause the engine to overheat and result in serious engine damage.



STARTING THE GENERATOR

If this is not your first time using the generator there are still steps you should take to prepare it for operation each time you use it.

IMPORTANT: At this point you should be familiar with the procedures described in the first portion of this section entitled “GENERATOR SETUP” If you have not yet read this section, go back and read it now.

BEFORE YOU START YOUR GENERATOR

Step 1 - Check the oil



1. Check the oil

The generator is equipped with an automatic shutoff to protect it from damage due to low oil. Nonetheless, you should check the oil level of the engine before each use to ensure that the engine crankcase has a sufficient amount.

To check the oil level:

- a. Make sure the generator is on a level surface.
- b. Unscrew the oil filler/dipstick cap.
- c. With a dry cloth, wipe the oil off of the stick on the inside of the cap.
- d. Insert the dipstick as if you were replacing the cap and then remove again. There should now be oil on the stick. If there is no oil on the stick, or oil only at the very end of the stick, you should add oil until the engine crankcase is filled (see “Adding Oil” portion of the “Maintenance” section).
- e. Be sure to replace the cap when finished checking oil.



NOTE: The oil capacity for your generator can be found in the “Specifications” section of this manual.

Step 2 - Check the gas level

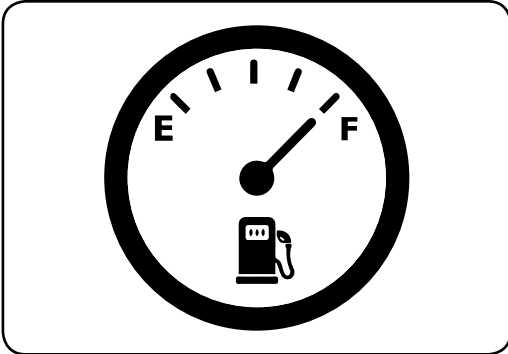

1. Check Fuel Level

Before starting the generator, check to see that there is sufficient gasoline in the fuel tank.



WARNING: Gasoline and gasoline fumes are highly flammable.

- Do not fill tank near an open flame.
- Always allow engine to cool for several minutes before refueling.
- DO NOT overfill fuel tank. Fuel expands when shaken or heated. ALWAYS leave 1½" space or more at the top of the tank.
- ALWAYS use fresh fuel or stabilized fuel. Old gasoline (older than 30 days) can cause permanent damage to the fuel system.
- Always check for fuel spills.

STARTING THE GENERATOR

Starting the Generator

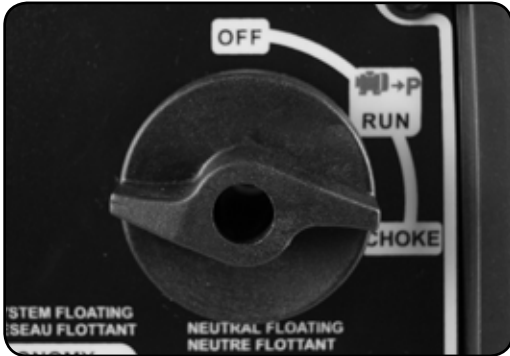

1. Switch start selector to Choke

Turn the Start Switch Selector knob to Start.



2. Turn gas valve on

The gas valve is located on the gas cap. Rotate the valve counter clockwise to the ON position.



3. Turn eco mode off

Set the eco mode switch to off when using propane.



4. Pull Recoil

Pull the recoil start handle briskly. It may take 2 to 3 pulls to the unit to start.

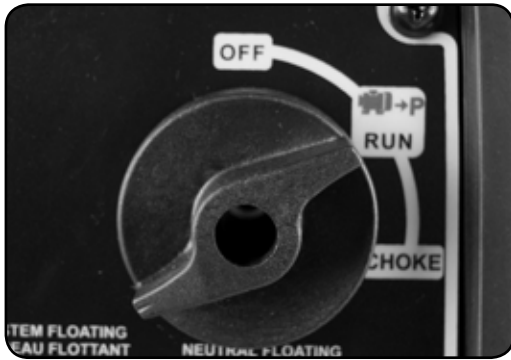

5. Switch start selector to Run

Turn the Start Switch Selector knob to Run.



CAUTION: Disconnect all electrical loads from the generator before attempting to start!



USING THE GENERATOR

If this is not your first time using the generator there are still steps you should take to prepare it for operation each time you use it.

IMPORTANT: At this point you should be familiar with the procedures described in the first portion of this section entitled “GENERATOR SETUP” If you have not yet read this section, go back and read it now.

USING THE GENERATOR

AC Usage

- You may connect electrical devices running on AC current according to their wattage requirements.
- The chart below shows the rated and surge wattage of your generator according to its model number.
- The rated wattage corresponds to the maximum wattage the generator can output on a continuous basis.
- The surge wattage corresponds to the maximum amount of power the generator can output for a short period of time. Many electrical devices such as refrigerators require short bursts of extra power, in addition the rated wattage listed by the device, to stop and start their motors. The surge wattage ability of the generator covers this extra power requirement.

| Fuel Source | Rated (Running Wattage) | Surge (Peak) Wattage |
|-------------|-------------------------|----------------------|
| Gasoline | 1800 | 2200 |

The total running wattage requirement of the electrical devices connected to the generator should not exceed the rated wattage of the generator itself. To calculate the total wattage requirement of the electrical devices you wish to connect, find the rated (or running) wattage of each device. This number should be listed somewhere on the device or in its instruction manual.

If you cannot find this wattage, you may calculate it by multiplying the Voltage requirement by the Amperage drawn: $\text{Watts} = \text{Volts} \times \text{Amps}$. If these specifications are not available you may estimate the Watts required by your device by using the chart on the next page.

Once you have found the rated wattage requirement of each electrical device, add these numbers to find the total rated wattage you wish to draw from the generator. If this number exceeds the rated wattage of the generator, DO NOT connect all these devices. Select a combination of electrical devices, which has a total rated wattage lower than or equal to the rated wattage of the generator.

| Tool or Appliance | Rated (Running) Watts | Additional Surge Watts |
|--------------------------------|------------------------------|-------------------------------|
| Electric water heater (40 gal) | 4000 | 0 |
| Hot plate | 2500 | 0 |
| Radial arm saw | 2000 | 2000 |
| Electric Stove | 1500 | 0 |
| Circular Saw | 1500 | 1500 |
| Air compressor (1 HP) | 1500 | 3000 |
| Window air conditioner | 1200 | 1800 |
| Miter saw | 1200 | 1800 |
| Microwave | 1000 | 2000 |
| Well water pump | 1000 | 1500 |
| Reciprocating saw | 960 | 1040 |
| Sump pump | 800 | 1200 |
| Refrigerator freezer | 800 | 1200 |
| Furnace blower | 800 | 1300 |
| Computer | 800 | 0 |
| Electric drill | 600 | 900 |
| Television | 500 | 0 |
| Deep freezer | 500 | 800 |
| Garage door opener | 480 | 600 |
| Stereo | 400 | 0 |
| Box fan | 300 | 600 |
| Clock radio | 300 | 0 |
| Security system | 180 | 0 |
| DVD Player | 100 | 0 |
| Common light bulb | 75 | 0 |



CAUTION - The generator can only run at its surge wattage capacity for a very short time. Connect only electrical devices requiring a rated (running) wattage equal to or less than the rated wattage of the generator. Never connect devices requiring a rated wattage equal to the surge wattage of the generator.

*NOTE: The above wattage figures are estimates only.
Try to check the wattage listed on your electrical devices before consulting this chart.*

USING THE GENERATOR (CONTINUED)

Connecting a load to the generator

NOTE: Be sure to attach devices to the correct receptacle (outlet).

- 120v devices can be directly connected to the 120v ONLY receptacles.
- 120v devices can be connected to the 120/240v receptacle using an appropriate adapter.
- 240v devices can NOT be connected.



CAUTION: Do not connect 50Hz or 3-phase loads to the generator.



1. Plug in devices

Plug in devices to the appropriate receptacle.



2. Turn on EcoMode

Eco mode idles the generator's motor up and down based on the load which saves fuel and noise.



3. Turn on connected devices

Start or turn on appliances starting with the biggest loads first.

Choosing the right power cord

Long or thin cords can drain the power provided to an electrical device by the generator. When using such cords, allow for a slightly higher rated wattage requirement for the electrical device. See table below for recommended cords based on the power requirement of the electrical device.

| DEVICE REQUIREMENTS | | WIRE GAUGE BY LENGTH (ft.) | | | | |
|------------------------------|------------------|----------------------------|----|----|-----|-----|
| AMPS | WATTS (120/240V) | 10 | 25 | 50 | 100 | 150 |
| 5 | 600/1200 | 18 | 16 | 14 | 12 | 10 |
| 10 | 1200/2400 | 16 | 14 | 12 | 10 | 8 |
| 15 | 1800/3600 | 14 | 12 | 10 | 8 | 6 |
| 20 | 2400/4800 | 12 | 10 | 8 | 6 | 4 |
| 25 | 3000/6000 | 10 | 8 | 6 | 4 | 4 |
| 30 | 3600/7200 | 8 | 6 | 4 | 4 | NR |
| 40 | 4800/9600 | 6 | 4 | 4 | NR | NR |
| 50 | 6000/1200 | 4 | 4 | 2 | NR | NR |
| *NR = NOT RECOMMENDED | | | | | | |

USING THE GENERATOR (CONTINUED)

Parallel Usage



CAUTION: Parallel usage requires use of the XP2000PK Parallel Kit, Sold Separately.



CAUTION: Only Parallel Capable with the DuroMax 2000 and 2200 Inverter Generators.



1. Connect Power, Gen #1

Connect one set of the Red Parallel Cables from the Parallel Kit to the Parallel Operation Outlets on bottom of the front panel of the 1st generator.

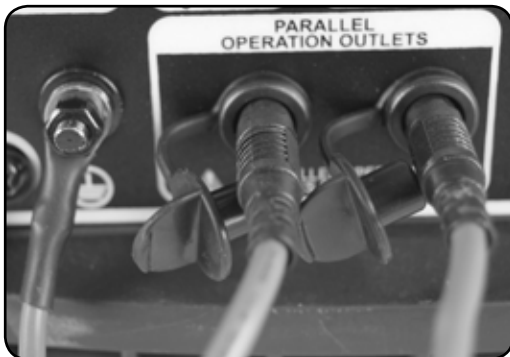

2. Connect Ground, Gen #1

Connect the Green Ground wire from the Parallel Kit to the ground lug on the bottom left of the front panel 1st generator.



3. Connect Power, Gen #2

Connect one set of the Red Parallel Cables from the Parallel Kit to the Parallel Operation Outlets on bottom of the front panel of the 2nd generator.

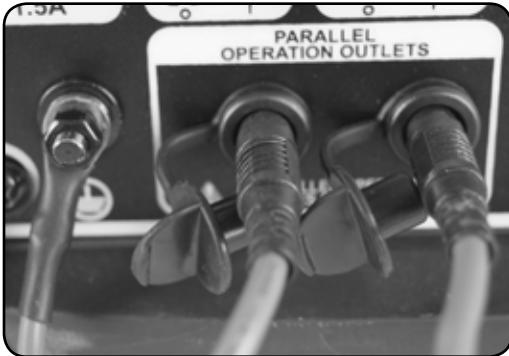

4. Connect Ground, Gen #2

Connect the Green Ground wire from the Parallel Kit to the ground lug on the bottom left of the front panel 2nd generator.



5. Start the Generators

Start both generators according to the instructions found on pages 24 - 28.



CAUTION: Do not draw power from the Parallel Kit until both units have been started.



6. Connect your Load

Connect your RV or large 30A appliance to either the TT-30R 30A RV Plug or 5-30R 30A 120v Plug found on the Parallel Kit.

USING THE GENERATOR (CONTINUED)

USB Usage



CAUTION: Only plug in devices that require 5 VDC, 1.5A or less.



CAUTION: Only connect USB after generator has been started and is producing power.



1. Start the Generator

Start the generator according to the instructions found on pages 24 - 28.



2. Connect USB

Plug your USB powered item into the 1.5A 5V USB Outlet on the front panel of the generator.



3. Charge Devices

Connect one set of the Red Parallel Cables from the Parallel Kit to the Parallel Operation Outlets on bottom of the front panel of the 2nd generator.

12V Auto Usage



CAUTION: Only plug in devices that require 12 VDC.



CAUTION: Only connect 12v Auto after generator has been started and is producing power.



1. Start the Generator

Start the generator according to the instructions found on pages 24 - 28.



2. Connect 12v Auto

Plug your 12v powered item into the 8A 12V Barrel Outlet on the front panel of the generator.



3. Use Devices

Connect one set of the Red Parallel Cables from the Parallel Kit to the Parallel Operation Outlets on bottom of the front panel of the 2nd generator.



MAINTENANCE AND CARE

Proper maintenance and storage of your generator is essential to ensure trouble free use of your generator when you need it.

By following the maintenance and care requirements, you can keep your generator running smooth and efficient for years to come.

MAINTENANCE AND CARE

Proper routine maintenance of your generator is essential for safe, economical, and trouble-free operation. It will also help reduce air pollution.



WARNING: Improper maintenance, or failure to correct a problem before operation, can cause a malfunction in which you can be seriously injured or killed. Always follow the inspection and maintenance recommendations and schedules in this instruction manual.

- Make sure the engine is off before you begin any maintenance or repairs.
- Let the engine and exhaust system cool before touching.
- To reduce the possibility of fire or explosion, be careful when working around gasoline. Use only a nonflammable solvent, not gasoline, to clean parts. Keep cigarettes, sparks, and flames away from all fuel related parts.

Maintenance Schedule

Remember that this schedule is based on the assumption that your machine will be used for its designed purpose. Sustained high-load, high temperature operation, or use in unusually wet or dusty conditions, will require more frequent service.

| SERVICE | | REGULAR SERVICE PERIOD | | | | |
|---|----------------|--|---------------------|-----------------------|------------------------|-------------------------|
| | | BEFORE EACH USE | EVERY MO. OR 20 HRS | EVERY 3 MO. OR 50 HRS | EVERY 6 MO. OR 100 HRS | EVERY 12 MO. OR 300 HRS |
| ENGINE OIL | CHECK | | | | | |
| | CHANGE | | | | | |
| AIR CLEANER | CHECK | | | | | |
| | CHANGE | | | | | |
| SEDIMENT CUP | CLEAN | | | | | |
| SPARK PLUG | CLEAN-ADJUST | | | | | |
| | REPLACE | | | | | |
| SPARK ARRESTOR | CLEAN | | | | | |
| IDLE SPEED | CHECK / ADJUST | | | | | |
| VALVE CLEARANCE | CHECK-ADJUST | | | | | |
| COMBUSTION CHAMBER | CLEAN | 500 HOURS | | | | |
| FUEL TANK / FILTER | CLEAN | | | | | |
| FUEL TUBE | CHECK | EVERY 24 MO. (REPLACE IF NECESSARY) | | | | |
| TO BE PERFORMED AT EVERY MONTH INDICATED OR HOUR INTERVAL WHICH EVER COMES FIRST | | | | | | |

MAINTENANCE AND CARE (CONTINUED)

Checking the oil

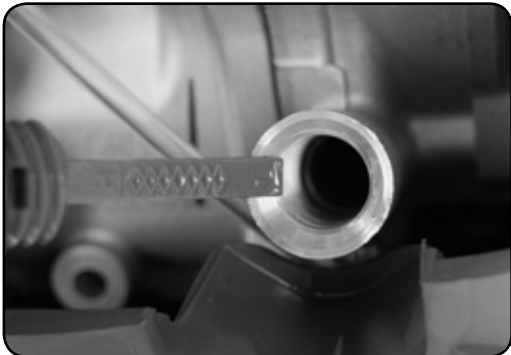

1. Check the oil

The generator is equipped with an automatic shutoff to protect it from damage due to low oil. Nonetheless, you should check the oil level of the engine before each use to ensure that the engine crankcase has a sufficient amount.

To check the oil level:

- a. Make sure the generator is on a level surface.
- b. Unscrew the oil filler/dipstick cap.
- c. With a dry cloth, wipe the oil off of the stick on the inside of the cap.
- d. Insert the dipstick as if you were replacing the cap and then remove again. There should now be oil on the stick. If there is no oil on the stick, or oil only at the very end of the stick, you should add oil until the engine crankcase is filled (see “Adding Oil” portion of the “Maintenance” section).
- e. Be sure to replace the cap when finished checking oil.

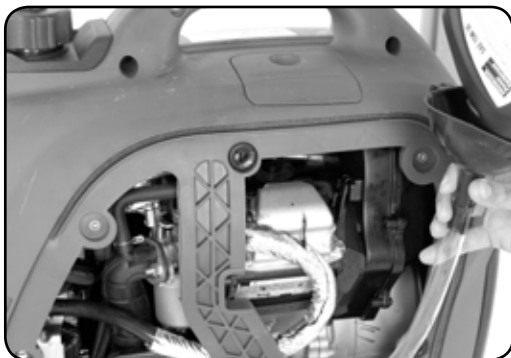

NOTE: The oil capacity for your generator can be found in the “Specifications” section of this manual.

Changing the oil

Worn out or dirty oil does not cool the generator properly and can lead to catastrophic engine damage.

In addition to regular oil changes, it is necessary to drain the oil from the crankcase if it has become contaminated with water or dirt.



2. Remove Oil Fill Cap

Unscrew the oil fill cap.



2. Drain oil

Tip the generator towards the open door to drain the oil from the oil fill into an approved oil disposal container. Contact your local auto parts store for information on oil disposal.

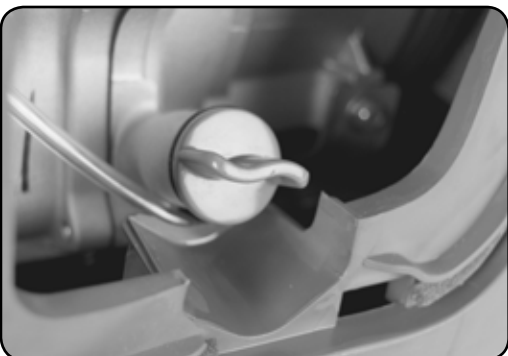

3. Replace Oil Fill Cap

Replace the oil fill cap and tighten.

MAINTENANCE AND CARE (CONTINUED)

Cleaning the air cleaner

Routine maintenance of the air cleaner helps maintain proper airflow to the carburetor. Check that the air cleaner is free of excessive dirt after every use.

Note: Improper maintenance may cause less air to enter the engine or dirty air to enter the engine causing overheating and engine wear.



1. Open cleaner cover

Unhinge the clasps at the top and bottom of the air cleaner cover.



2. Remove cleaner element

Remove the sponge-like elements from the casing.



3. Wipe out cleaner casing

Wipe the dirt from inside the empty air cleaner casing.



4. Wash cleaner element

Wash the sponge-like elements in household dish detergent and warm water.



5. Dry cleaner element

Allow the elements to dry completely.

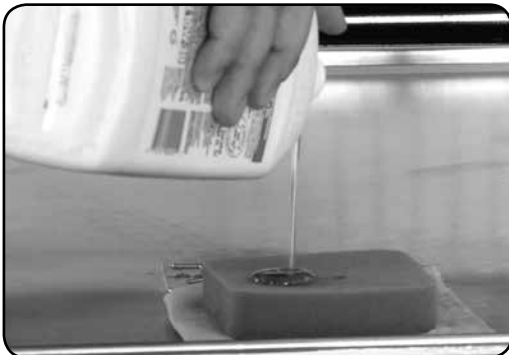

6. Add engine oil to elements

Soak the dry elements in a small amount of engine oil. Ring out any excess oil.

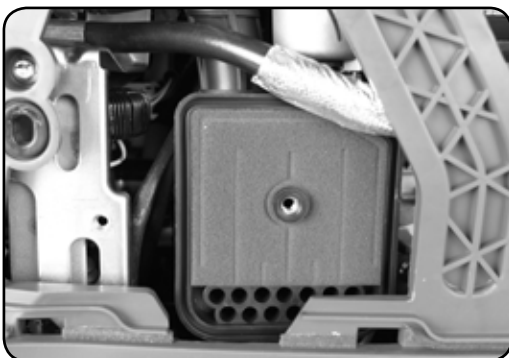

7. Replace elements in casing

Replace the sponge-like elements in the air cleaner casing and replace the cover.

MAINTENANCE AND CARE (CONTINUED)

Spark Plug Maintenance

The spark plug is important for proper engine operation. A good spark plug should be intact, free of deposits, and properly gapped.

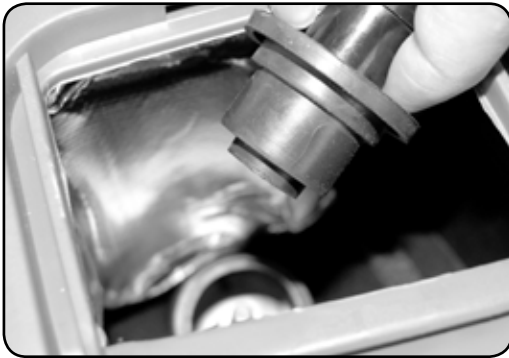

1. Remove spark plug cap

Pull on the spark plug cap to remove it.

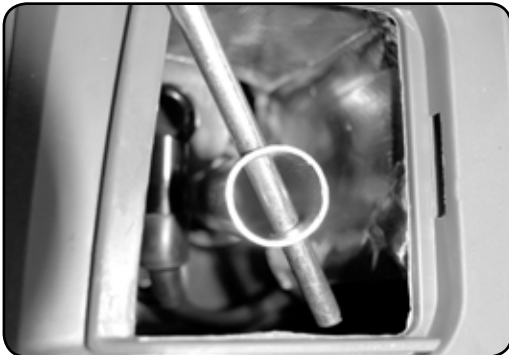

2. Remove spark plug

Unscrew the spark plug from the generator using the spark plug wrench included with this product.



3. Inspect spark plug

Visually inspect the spark plug. If it is cracked or chipped, discard and replace with a new spark plug. We recommend using a F6RTC spark plug such as NGK BPR5ES.



4. Measure plug gap

Measure the plug gap with a gauge. The gap should be 0.7-0.8 mm (0.028-0.031 in).



5. Clean and re-gap

If you are re-using the spark plug, use a wire brush to clean any dirt from around the spark plug base and then re-gap the spark plug.



6. Replace spark plug

Screw the spark plug back into its place on the generator using the spark plug wrench.



7. Replace spark plug cap

Replace the spark plug cap.

MAINTENANCE AND CARE (CONTINUED)

Storage and Transportation



CAUTION: Never place any type of storage cover on the generator while it is still hot.

When transporting your generator:

- Empty the gas tank (see “Emptying the Gas Tank” in the “Maintenance” section).
- Disconnect the spark plug.
- Do not obstruct any ventilation openings & keep the generator in a cool dry area.

| Storage Period | Storage Preparation |
|--|---|
| If you plan on starting the same day. | <ol style="list-style-type: none">1. Turn off the main breaker.2. Allow the unit to run 3 - 5 minutes.3. Turn off the key.4. Store. |
| If you plan on starting the unit again within 30 days. | <ol style="list-style-type: none">1. Turn off the main breaker.2. Allow the unit to run 3 - 5 minutes.3. Turn off the fuel valve.4. Allow the unit to stall out.5. Turn off the key.6. Add fuel stabilizer to the gas remaining in the tank.7. Store. |
| If you do not plan to start the unit for longer than 30 days. | <ol style="list-style-type: none">1. Turn off the main breaker.2. Allow the unit to run 3 - 5 minutes.3. Turn off the fuel valve.4. Allow the unit to stall out.5. Turn off the key.6. Drain the fuel tank (See “Emptying the Gas Tank” in the “Maintenance” section)7. Drain the carburetor<ol style="list-style-type: none">a. Remove the drain bolt from the carburetor.b. Drain the small amount of remaining fuel from the carburetor bowl.8. Oil the cylinder<ol style="list-style-type: none">a. Remove the spark plug.b. Put 2 tbsp. of 10w30 motor oil directly into the spark plug holec. Pull the recoil start one time.d. Replace the plug.9. Remove the battery and place on tender indoors. |

SPECIFICATIONS

| | | |
|----------------------------------|-------------------------|---------|
| AC Rated Wattage | 1800W | |
| AC Surge Wattage | 2200W | |
| AC Rated Voltage | 120V | |
| AC Rated Frequency | 60 Hz | |
| AC Phase | Single | |
| DC Voltage | 12V / 5V | |
| DC Amperage | 8A / 1.5A | |
| Dimensions | LENGTH | 19.8in. |
| | WIDTH | 11.4in. |
| | HEIGHT | 17.9in. |
| Engine Type | 4-Stroke OHV Forced-Air | |
| Ignition System | Non-Contact Transistor | |
| Displacement | 79cc | |
| Starting Type | Electric | |
| Fuel Tank Capacity | 1.2 US Gal. (4.5L) | |
| Oil Capacity | 11.8 fl. oz. (0.3L) | |
| Run Time @ 50% (Gasoline) | 10 hr. | |
| Run Time @ 50% (Propane) | 16 hr. (5 Gallon) | |
| Noise Level | 52dB @ 25% Load | |



TROUBLESHOOTING

This section of the manual is to help you troubleshoot problems with your generator.

TROUBLESHOOTING

| Mode | Description | |
|---|---|---|
| Engine will not start | Engine Switch is "Off" | Set engine switch to "run" |
| | Fuel Valve is "Closed" | Turn fuel valve to "open" |
| | Choke is open | Close the choke |
| | Engine is out of fuel | Add fuel |
| | Fuel is old or contaminated | Change fuel |
| | Spark Plug is dirty | Clean spark plug |
| | Spark Plug is broken | Replace spark plug |
| | Generator is not level | Move generator to a level surface |
| | Oil is low | Add / change oil |
| Engine runs, but there is no electrical output. | Circuit Breaker is "Off" | Turn "on" circuit breaker |
| | Wiring connection is bad | Replace extension cord(s) |
| | Device connected to generator is Malfunctioning | Disconnect malfunctioning device |
| Generator runs, but does not support all electrical devices connected. | Generator is overloaded | Disconnect 1 or more items to reduce the load |
| | Device connected to generator is bad | Disconnect malfunctioning device |
| | Air Cleaner is Dirty | Clean / replace the air filter |

WIRING DIAGRAM

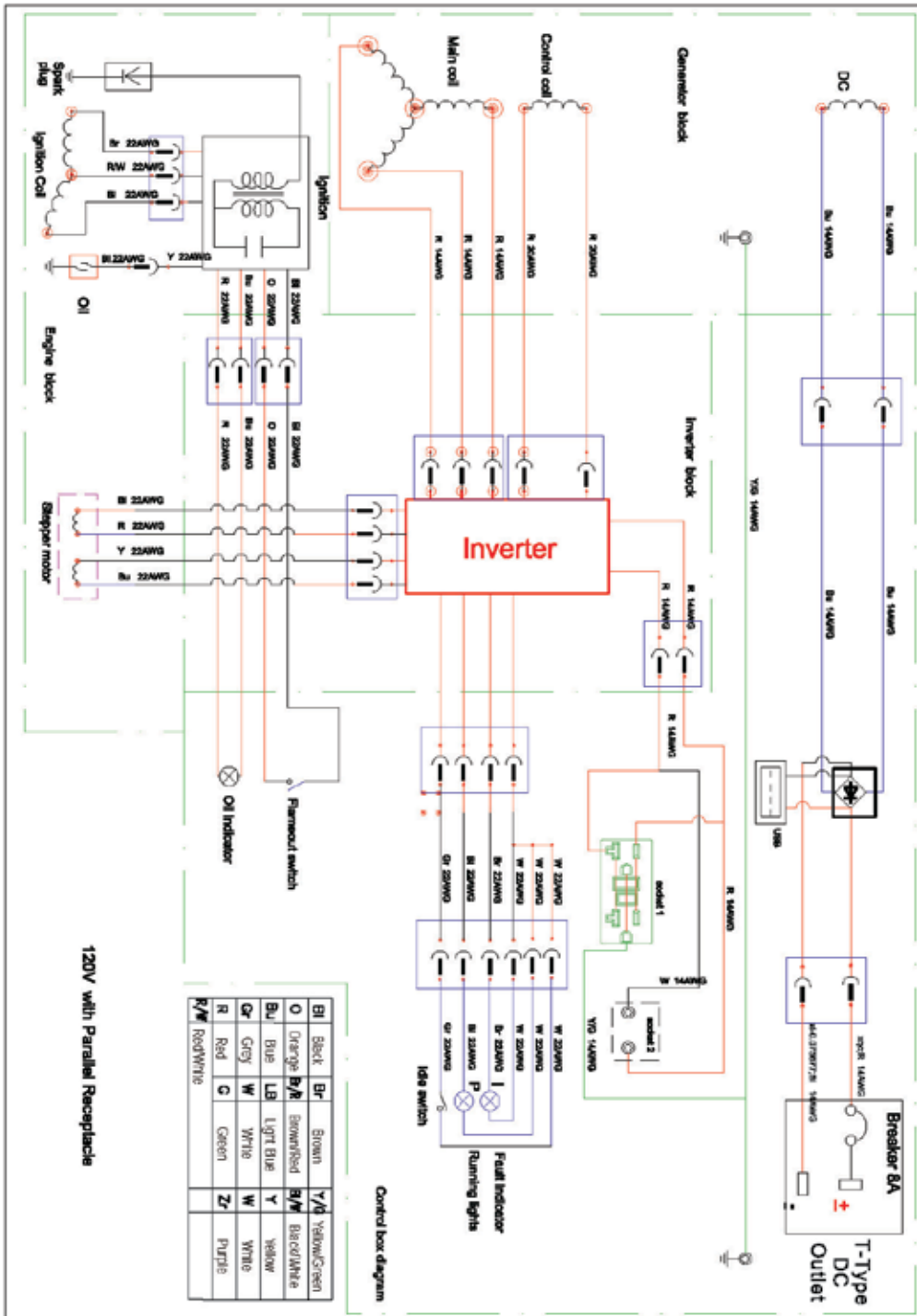

WARRANTY

3-year Warranty

All DuroMax/DuroStar Power Equipment warrant the original purchasers to a 3-year Parts Warranty (Residential Use ONLY: Unusually heavy or commercial use is covered for a period of 1-year) in the event of failure due to defects in electrical or mechanical components. Freight on any items submitted for replacement or repair under the Warranty are the responsibility of the equipment owner. This warranty is non-transferable and only valid to the original purchaser.

Warranty Exclusions

The DuroMax/DuroStar Power Equipment warranty does not cover repairs or returns when the fault is: Normal Wear and Tear, Installation Use or Maintenance Services, Cosmetic defects, Accessories, Failures due to acts of God or Natural Disasters, or problems related to/from aftermarket or non-OEM parts.

Warranty Limitations

DuroMax/DuroStar Power Equipment does not claim or hold any obligation to loss of time, freight charges, use of product, or any incidental damages from the use of this product. THIS WARRANTY IS IN LIEU OF ALL OTHER WARRANTIES, EXPRESSED OR IMPLIED.

U.S. EPA AND CALIFORNIA EMISSIONS CONTROL WARRANTY STATEMENT YOUR WARRANTY RIGHTS AND OBLIGATIONS

The U.S. Environmental Protection Agency (EPA), California Air Resources Board, and Imperial Industrial Supply Co. LTD. / DuroMax Power Equipment are pleased to explain the emissions control system's warranty on your 2018 small off-road engine. In California, new equipment that use small off-road engines must be designed, built, and equipped to meet the State's stringent anti-smog standards. DuroMax Power Equipment must warrant the emissions control system on your small off-road engine for the period listed below provided there has been no abuse, neglect, or improper maintenance of your equipment.

Your emissions control system may include parts such as: carburetors or the fuel injection system, ignition system, catalytic converters, fuel tanks, valves, filters, clamps, connectors, and other associated components. Also, included may be hoses, belts, connectors, sensors, and other emission-related assemblies.

Where a warrantable condition exists, DuroMax Power Equipment will repair your small off-road engine at no cost to you including diagnosis, parts, and labor.

MANUFACTURER'S WARRANTY COVERAGE:

This emissions control system is warranted for two years. If any emissions-related part on your equipment is defective, the part will be repaired or replaced by DuroMax Power Equipment.

OWNER'S WARRANTY RESPONSIBILITIES:

- As the small off-road engine owner, you are responsible for performance of the required maintenance listed in your owner's manual. DuroMax Power Equipment recommends that you retain all receipts covering maintenance on your small off-road engine, but DuroMax Power Equipment cannot deny warranty solely for the lack of receipts or your failure to ensure the performance of all scheduled maintenance.
- As the small off-road engine owner, you should however be aware that the DuroMax Power Equipment may deny you warranty coverage if your small off-road engine or a part has failed due to abuse, neglect, or improper maintenance or unapproved modifications.
- You are responsible for presenting your small off-road engine to a DuroMax Power Equipment distribution center or service center as soon as the problem exists. The warranty repairs should be completed in a reasonable amount of time, not to exceed 30 days.
- If you have any questions regarding your warranty coverage, contact us at 844-DUROMAX or email support@duromaxpowerequipment.com.

DEFECTS WARRANTY REQUIREMENTS:

The warranty period begins on the date the engine or equipment is delivered to an ultimate purchaser and extends for a period of Two Years.

GENERAL EMISSIONS WARRANTY COVERAGE:

DuroMax Power Equipment warrants to the ultimate purchaser and each subsequent owner that the engine or equipment is:

1. Designed, built, and equipped to conform with all applicable regulations adopted by the Air Resources Board; and
2. Free from defects in materials and workmanship that causes the failure of a warranted part for a period of two years.

The warranty on emissions-related parts will be interpreted as follows:

1. Any warranted part that is not scheduled for replacement as required maintenance in the Owner's Manual must be warranted for the warranty period stated above. If any such part fails during the period of warranty coverage, it must be repaired or replaced by the manufacturer according to Subsection (4) below. Any such part repaired or replaced under the warranty must be warranted for the remaining warranty period.

WARRANTY (CONTINUED)

1. Any warranted part that is scheduled only for regular inspection in the Owner's Manual must be warranted for the warranty period stated above. A statement in such written instructions to the effect of "repair or replace as necessary" will not reduce the period of warranty coverage. Any such part repaired or replaced under warranty must be warranted for the remaining warranty period.
2. Any warranted part that is scheduled for replacement as required maintenance in the Owner's Manual must be warranted for the period prior to the first scheduled replacement point for that part. If the part fails prior to the first scheduled replacement, the part must be repaired or replaced by the engine manufacturer according to Subsection (4) below. Any such part repaired or replaced under warranty must be warranted for the remainder of the period prior to the first scheduled replacement point for the part.
3. Repair or replacement of any warranted part under the warranty must be performed at no charge to the owner at a warranty station.
4. Notwithstanding the provisions of Subsection (4) above, warranty services or repairs must be provided at all manufacturer distribution centers that are franchised to service the subject engines.
5. The owner must not be charged for diagnostic labor that leads to the determination that a warranted part is in fact defective, provided that such diagnostic work is performed at a warranty station.
6. The manufacturer is liable for damages to other engine components proximately caused by a failure under warranty of any warranted part.
7. Throughout the emissions warranty period stated above, the manufacturer must maintain a supply of warranted parts sufficient to meet the expected demand for such parts.
8. Any replacement part may be used in the performance of any warranty maintenance or repairs and must be provided without charge to the owner.
 - a. Such use will not reduce the warranty obligations of the manufacturer.
9. Add-on or modified parts that are not exempted by the Air Resources Board may not be used. The use of any nonexempt add-on or modified parts will be grounds for disallowing a warranty claim. The manufacturer will not be liable to warrant failures of warranted parts caused using a nonexempt add-on or modified part.
10. The manufacturer issuing the warranty shall provide any documents that describe that manufacturer's warranty procedures or policies within five working days of request by the Air Resources Board.

- Exhaust Emission Warranty Parts List.
1. Fuel Metering System
 - i. Carburetor and internal parts (and/or pressure regulator or fuel injection system).
 - ii. Air/fuel ratio feedback and control system.
 - iii. Cold start enrichment system.
 2. Air Induction System
 - i. Controlled hot air intake system.
 - ii. Intake manifold.
 3. Ignition System
 - i. Spark Plugs.
 - ii. Magneto or electronic ignition system.
 - iii. Spark advance/retard system.
 4. Air Injection System
 - i. Air pump or pulse valve.
 - ii. Valves affecting distribution of flow.
 - iii. Distribution manifold.
 5. Catalyst or Thermal Reactor System (i) Catalytic converter.
 - i. Thermal reactor.
 - ii. Exhaust manifold.
 6. Particulate Controls
 7. Traps, filters, precipitators, and any other device used to capture particulate emissions.
 8. Electronic controls.
 9. Vacuum, temperature, and time sensitive valves and switches.
 10. Hoses, belts, connectors, and assemblies.
 11. Evaporative Emission Warranty Part List
 - i. Fuel Tank*
 - ii. Fuel Cap
 - iii. Fuel Line
 - iv. Fuel Line Fittings
 - v. Clamps**
 - vi. Pressure Relief Valves**
 - vii. Control Valves**
 - viii. Control Solenoids**
 - ix. Electronic Controls**
 - x. Vacuum Control Diaphragms**
 - xi. Control Cables**
 - xii. Control Linkages**
 - xiii. Purge Valves
 - xiv. Vapor Hoses
 - xv. Liquid/Vapor Separator
 - xvi. Carbon Canister
 - xvii. Canister Mounting Brackets
 - xviii. Carburetor Purge Port Connector

CUSTOMER SERVICE

Duromax Power Equipment is committed to ensuring that our products perform when they need to. Our generators are your lifeline in the event of an emergency. Should you have any problems, please contact our customer service department:

DUROMAX POWER EQUIPMENT
5800 Ontario Mills Parkway
Ontario, CA 91764

Customer Service: 844-DUROMAX
Customer Service Hours: 8-5pm PST

Website: www.duromaxpower.com
Email: customerservice@duromaxpower.com







5800 Ontario Mills Parkway
Ontario, CA 91764
United States

844-DUROMAX