

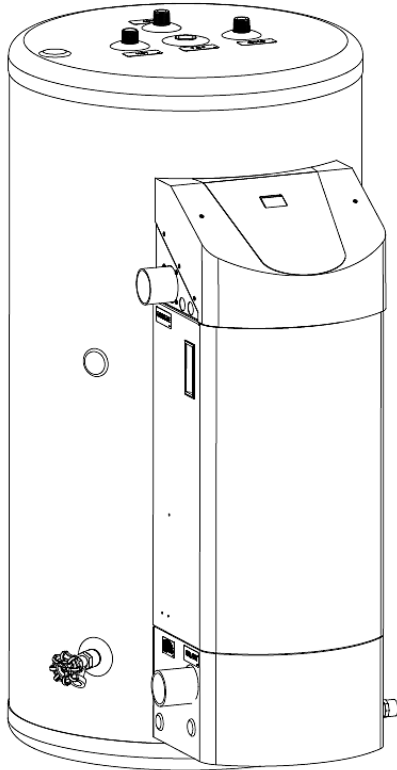

Westinghouse

High Efficiency Water Heater



INSTALLATION

START-UP

MAINTENANCE

PARTS

*Models**

**WGR050NG076 / WGR060NG076 / WGR080NG076
WGR050LP076 / WGR060LP076 / WGR080LP076**



⚠ DANGER

This manual must only be used by a qualified heating installer/service technician. Read and understand all instructions in this manual before installing. Perform steps in the order given. Failure to comply will result in substantial property damage, severe personal injury, or death.

⚠ WARNING

Improper installation, adjustment, alteration, service, or maintenance could void product warranty and cause property damage, personal injury, or death.

NOTICE: Westinghouse reserves the right to make product changes or updates without notice and will not be held liable for typographical errors in literature.

The surfaces of these products contacted by consumable water contain less than 0.25% lead by weight, as required by the Safe Drinking Water Act, Section 1417.

NOTE TO CONSUMER: PLEASE KEEP ALL INSTRUCTIONS FOR FUTURE REFERENCE.

⚠ WARNING

IF THE INFORMATION IN THIS MANUAL IS NOT FOLLOWED EXACTLY, A FIRE OR EXPLOSION MAY RESULT, CAUSING PROPERTY DAMAGE, PERSONAL INJURY, OR LOSS OF LIFE. DO NOT STORE GASOLINE OR OTHER FLAMMABLE VAPORS AND LIQUIDS IN THE VICINITY OF THIS OR ANY OTHER APPLIANCE.

WHAT TO DO IF YOU SMELL GAS

- Do not try to light any appliance.
- Do not touch any electrical switch.
- Do not use any phone in your building.
- Immediately call your gas supplier from a neighbor's phone. Follow the gas supplier's instructions.
- If you cannot reach your gas supplier, call the fire department. Installation and service must be provided by a qualified installer, service agency, or the gas supplier.

FOR YOUR SAFETY READ BEFORE OPERATING

WARNING: If you do not follow these instructions exactly, a fire or explosion may result, causing property damage, personal injury or loss of life.

- A.** This appliance does not have a pilot. It is equipped with an ignition device which automatically lights the burner. Do not try to light the burner by hand.
- B.** BEFORE OPERATING smell all around the appliance area for gas. Be sure to smell next to the floor because some gas is heavier than air and will settle on the floor.
- WHAT TO DO IF YOU SMELL GAS**
- Do not try to light any appliance
 - Do not touch any electric switch; do not use any phone in your building
 - Immediately call your gas supplier from a neighbor's phone. Follow the gas suppliers' instructions.
- If you cannot reach your gas supplier, call the fire department.
- C.** Use only your hand to turn the gas control knob. Never use tools. If the handle will not turn by hand, don't try to repair it, call a qualified service technician. Force or attempted repair may result in a fire or explosion.
- D.** Do not use this appliance if any part has been under water. Immediately call a qualified service technician to inspect the appliance and to replace any part of the control system and any gas control which has been under water.

OPERATING INSTRUCTIONS

1. STOP! Read the safety information above.
2. Set the thermostat to lowest setting.
3. Turn off all electric power to the appliance.
4. This appliance is equipped with an ignition device which automatically lights the burner. Do not try to light the burner by hand.
5. Remove front cover.
6. Turn gas shutoff valve to "off". Handle will be across the piping, do not force.
7. Wait five (5) minutes to clear out any gas. If you then smell gas, STOP! Follow "B" in the safety information above on this label. If you don't smell gas, go to next step.
8. Turn gas shutoff valve to "on". Handle will be in line with piping.
9. Install Front Cover.
10. Turn on all electric power to appliance.
11. Set thermostat to desired setting.
12. If the appliance will not operate, follow the instructions "To Turn Off Gas To Appliance" and call your service technician or gas supplier.

GAS VALVE
ON

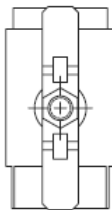

GAS VALVE
OFF

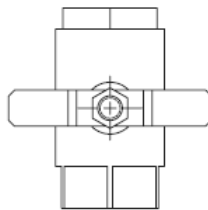

TO TURN OFF GAS TO APPLIANCE

1. Set the thermostat to lowest setting.
2. Turn off all electric power to the appliance if service is to be performed.
3. Remove Front Cover.
4. Turn gas shutoff valve to "off". Handle will be across the piping. Do not force.
5. Install Front Cover.

LP-175 Rev. 4 3-11-08

SPECIAL ATTENTION BOXES

The following defined terms are used throughout this manual to bring attention to the presence of hazards of various risk levels, or to important product information.

DANGER

DANGER indicates an imminently hazardous situation which, if not avoided, will result in death or serious injury.

WARNING

WARNING indicates a potentially hazardous situation which, if not avoided, could result in death or serious injury.

CAUTION

CAUTION indicates a potentially hazardous situation which, if not avoided, may result in minor or moderate injury.

CAUTION

CAUTION used without the safety alert symbol indicates a potentially hazardous situation which, if not avoided, may result in property damage.

NOTICE

NOTICE is used to address practices not related to personal injury.

FOREWORD

This manual is intended to be used in conjunction with other literature provided with the High Efficiency Water Heater. This includes all related control information. It is important that this manual, all other documents included with this system, and additional publications including the National Fuel Gas Code, ANSI Z223.1-2002, be reviewed in their entirety before beginning any work.

Installation should be made in accordance with the regulations of the Authority Having Jurisdiction, local code authorities, and utility companies which pertain to this type of water heating equipment.

Authority Having Jurisdiction (AHJ) – The Authority Having Jurisdiction may be a federal, state, local government, or individual such as a fire chief, fire marshal, chief of a fire prevention bureau, labor department or health department, building official or electrical inspector, or *others having statutory authority*. In some circumstances, the property owner or his/her agent assumes the role, and at government installations, the commanding officer or departmental official may be the AHJ.

NOTE: Westinghouse reserves the right to modify product technical specifications and components without prior notice.

FOR THE INSTALLER

DANGER

This manual must only be used by a qualified heating installer/service technician. Read and understand all instructions in this manual before installing. Perform steps in the order given. Failure to comply will result in substantial property damage, severe personal injury, or death.

This water heater must be installed by qualified and licensed personnel. The installer should be guided by the instructions furnished with the heater, and with local codes and utility company requirements. In the absence of local codes, preference should be given to the National Fuel Gas Code, ANSI Z223.1-2002.

INSTALLATIONS MUST COMPLY WITH:

Local, state, provincial, and national codes, laws, regulations and ordinances.

The latest version of the National Fuel Gas Code, ANSI Z223.1, from American Gas Association Laboratories, 8501 East Pleasant Valley Road, Cleveland, OH 44131.

In Canada – CGA No. B149 (latest version), from Canadian Gas Association Laboratories, 55 Scarsdale Road, Don Mills, Ontario, Canada M3B 2R3. Also, Canadian Electrical Code C 22.1, from Canadian Standards Association, 5060 Spectrum Way, Suite 100, Mississauga, Ontario, Canada L4W 5N6.

Code for the installation of Heat Producing Appliances (latest version), from American Insurance Association, 85 John Street, New York, NY 11038.

The latest version of the National Electrical Code, NFPA No. 70.

NOTE: The gas manifold and controls met safe lighting and other performance criteria when undergoing tests specified in ANSI Z21.10.3 – latest edition.

TABLE OF CONTENTS

PART 1 – GENERAL SAFETY INFORMATION	6
A. PRECAUTIONS.....	6
B. IMPROPER COMBUSTION.....	6
C. GAS	7
D. WHEN SERVICING THE HEATER.....	7
E. HEATER WATER	7
PART 2 – BEFORE YOU START	7
A. WHAT'S IN THE BOX.....	7
B. HOW THE HEATER OPERATES	7
C. OPTIONAL EQUIPMENT	8
PART 3 – PREPARE WATER HEATER LOCATION	9
A. BEFORE LOCATING THE HEATER.....	9
B. LEVELING.....	10
C. CLEARANCES FOR SERVICE ACCESS.....	10
D. RESIDENTIAL GARAGE INSTALLATION.....	10
E. EXHAUST VENT AND INTAKE PIPE	11
1. DIRECT VENT INSTALLATION OF EXHAUST AND INTAKE	11
2. INDOOR COMBUSTION AIR INSTALLATION IN CONFINED OR UNCONFINED SPACE	11
F. PREVENT COMBUSTION AIR CONTAMINATION.....	12
G. REMOVING A HEATER FROM A COMMON VENT SYSTEM	12
H. WATER CHEMISTRY.....	13
PART 4 – HEATER PIPING	16
A. GENERAL PIPING INFORMATION.....	16
B. SCALDING	17
C. TEMPERATURE AND PRESSURE RELIEF VALVE	17
D. BACKFLOW PREVENTER.....	17
E. POTABLE EXPANSION TANK.....	17
F. WATER PIPING.....	18
G. AUXILIARY CONNECTIONS	18
H. FILLING THE HEATER	18
I. IMPORTANT NOTICE.....	19
J. PIPING DIAGRAMS	20

PART 5 – VENTING, COMBUSTION AIR AND CONDENSATE REMOVAL.....23

- A. GENERAL 23
- B. APPROVED MATERIALS FOR EXHAUST VENT AND INTAKE PIPE 24
- C. REQUIREMENTS FOR INSTALLATION IN CANADA 24
- D. EXHAUST VENT AND INTAKE PIPE LOCATION 25
- E. EXHAUST VENT AND INTAKE PIPE SIZING..... 26
- F. LONGER VENT RUNS 26
- G. EXHAUST VENT AND INTAKE PIPE INSTALLATION 27
- H. VENTING DRAWINGS 27
 - 1. DIRECT VENT INSTALLATION OF EXHAUST AND INTAKE 27
 - 2. VENTING THROUGH AN EXISTING SYSTEM 31
 - 3. INDOOR COMBUSTION AIR INSTALLATION IN CONFINED OR UNCONFINED SPACE 33
- I. CONDENSATE REMOVAL SYSTEM..... 35

PART 6 – WIRING37

- A. LINE VOLTAGE INPUT 37
- B. LINE VOLTAGE CONDENSATE OUTPUT 37
- C. LOW VOLTAGE OUTDOOR SENSOR INPUT 37
- D. INTERNAL WIRING DIAGRAM 38

PART 7 – GAS CONNECTIONS38

- A. GAS PIPING..... 39
- B. GAS TABLE..... 39
- C. GAS VALVE 40

PART 8 – CONTROLS.....41

- A. CONTROL AND DISPLAY OVERVIEW 41
- B. BASIC CONTROL FUNCTIONS 42
 - 1. TURNING WATER HEATER ON / OFF 42
 - 2. RESETTING THE WATER HEATER 42
 - 3. PUTTING THE WATER HEATER IN ECO MODE 42
 - 4. CHANGING USER SETPOINT 43
- C. ADVANCED CONTROL FUNCTIONS..... 43
 - 1. UPPER LEVEL INSTALLER MODE MENU NAVIGATION..... 43
 - 2. TECHNICAL SERVICE AND NAVIGATION..... 43
- D. OUTDOOR RESET 44
 - 1. INQUIRY MODE AND NAVIGATION 45
 - 2. HISTORY MODE AND NAVIGATION 45
 - 3. RESET MODE AND NAVIGATION 46

PART 9 – START-UP PROCEDURE.....47

- A. OPERATING INSTRUCTIONS 47
- B. TEST MODE..... 47
- C. MAINTENANCE 48

PART 10 – SHUTDOWN.....49

- A. SHUTDOWN PROCEDURE 49
- B. VACATION PROCEDURE..... 49
- C. FAILURE TO OPERATE 49

D. IMPORTANT NOTICE 49

PART 11 – TROUBLESHOOTING49

A. ERROR CODE 49

B. HEATER ERROR 49

C. LOCKOUT 49

PART 12 - MAINTENANCE55

MAINTENANCE NOTES 59

CUSTOMER INSTALLATION RECORD FORM 60

PART 1 – GENERAL SAFETY INFORMATION

A. PRECAUTIONS

This water heater is for indoor installations only. Clearance to combustible materials: 0” top, bottom, sides, front, and back. Unit must have room for service: 24” front, 3” left, 3” right, 6” top, and 0” back are minimum recommended service clearances. (A combustible door or removable panel is acceptable front clearance.) This water heater has been approved for closet installation, and installation on combustible flooring. Do not install this water heater directly on carpeting. Use only Category IV vent systems.

 WARNING
INSTALLER – Read all instructions in this manual before installing. Perform steps in the order given.
USER – This manual is for use only by a qualified heating installer/service technician. Have this heater serviced/inspected by a qualified service technician annually.
FAILURE TO ADHERE TO THE GUIDELINES ON THIS PAGE AND HAVE THIS HEATER SERVICED/INSPECTED ANNUALLY CAN RESULT IN SUBSTANTIAL PROPERTY DAMAGE, SEVERE PERSONAL INJURY, OR DEATH.

 WARNING
If the heater is exposed to the following, do not operate until all corrective steps have been made by a qualified service technician:
<ol style="list-style-type: none"> 1. FIRE 2. DAMAGE 3. WATER
Any claims for damage or shortage in shipment must be filed immediately against the transportation company by the consignee.

 WARNING
DO NOT USE THIS APPLIANCE IF ANY PART HAS BEEN SUBMERGED IN WATER. Immediately call a qualified service technician. The appliance MUST BE replaced if it has been submerged. Attempting to operate an appliance that has been submerged could create numerous harmful conditions, such as a potential gas leakage causing a fire and/or explosion, or the release of mold, bacteria, or other harmful particulates into the air. Operating a previously submerged appliance could result in property damage, severe personal injury, or death.
NOTE: Appliance damage due to flood or submersion is considered an Act of God, and IS NOT covered under product warranty.

 WARNING
Altering any Westinghouse appliance with parts not manufactured and/or approved by Westinghouse. WILL INSTANTLY VOID the appliance warranty and could result in property damage, serious personal injury, or death.

 WARNING
This water heater has been designed to heat potable water ONLY . Using this water heater to heat non-potable fluid WILL VOID product warranty, and could result in property damage, personal injury, or death.

B. IMPROPER COMBUSTION

 WARNING
Do not obstruct the flow of combustion and ventilating air. Adequate air is necessary for safe operation. Failure to keep the exhaust vent and combustion air intake clear of ice, snow, or other debris could result in property damage, serious personal injury, or death.

C. GAS



Should overheating or gas supply fail to shut off, turn off the manual gas control valve to the water heater.

D. WHEN SERVICING THE HEATER

- To avoid electric shock, disconnect electrical supply before performing maintenance.
- To avoid severe burns, allow heater to cool.

E. HEATER WATER

- Do not use petroleum-based cleaning or sealing compounds in a heater system. Gaskets and seals in the system may be damaged. This can result in substantial property damage.
- Do not use “homemade cures” or “patent medicines”. Substantial property damage, damage to heater, and/or serious personal injury may result.

	
<p>⚠ Vapors from flammable liquids will explode and catch fire causing death or severe burns.</p> <p>Do not use or store flammable products such as gasoline, solvents or adhesives in the same room or area near the water heater.</p> <p>Keep flammable products:</p> <ol style="list-style-type: none"> 1. far away from heater, 2. in approved containers, 3. tightly closed and 4. out of children's reach. 	<p>Water heater has a main burner and pilot flame.</p> <p>The pilot flame:</p> <ol style="list-style-type: none"> 1. which can come on at any time and 2. will ignite flammable vapors. <p>Vapors:</p> <ol style="list-style-type: none"> 1. cannot be seen, 2. are heavier than air, 3. go a long way on the floor and 4. can be carried from other rooms to the pilot flame by air currents.
<p>Installation:</p> <p>Do not install water heater where flammable products will be stored or used unless the main burner and pilot flames</p>	<p>are at least 18" above the floor. This will reduce, but not eliminate, the risk of vapors being ignited by the main burner or pilot flame.</p>
<p>Read and follow water heater warnings and instructions. If owners manual is missing, contact the retailer or manufacturer.</p>	
<p>Water temperature over 125°F can cause severe burns instantly or death from scalds. Children, disabled and elderly are at highest risk of being scalded.</p> <p>See instruction manual before setting temperature at water heater.</p> <p>Feel water before bathing or showering.</p> <p>Temperature limiting valves are available, see manual.</p>	

PART 2 – BEFORE YOU START

A. WHAT'S IN THE BOX

Also included with the heater:

- Intake PVC Tee with Screens
- Exhaust PVC Coupling with Screens
- Temperature and Pressure Relief Valve (Ships Installed)
- High Output Cold Water Dip Tube
- Installation Manual
- Warranty

B. HOW THE HEATER OPERATES

Modulation Condensing Technology is an intelligent system that delivers highly efficient water heating, while maximizing efficiency by measuring the data parameters of your water heating system. Some of its features are:

Stainless Steel Water Storage Tank

The stainless steel water storage tank has a combustion chamber submerged into the tank water. When the water heater is fired, combustion gases heat the combustion chamber walls, transferring heat directly into the surrounding water. These hot gases are blown into secondary heat exchanger coils, where more heat is transferred into the water, removing even more heat from the gases.

Modulating Combustion System

Modulation during water heating operation is based on tank temperature. The control monitors the system to regulate burner output during operation to match system demand. This increase in efficiency allows for substantial fuel savings.

High Output Cold Water Dip Tube (Optional – Supplied with Water Heater)

Increases hot water draw by 20% when installed. The High Output Cold Water Dip Tube also increases recovery time by 20%, and decreases thermal efficiency by a small amount.

Gas Valve

The gas valve senses suction from the blower, allowing gas to flow only if the gas valve is energized and combustion air is flowing.

Tank Sensor

This sensor monitors system water temperature. The control module adjusts the burner firing rate so the outlet water temperature meets the set point.

Control

The integrated control system monitors water temperature and regulates fan speed to regulate the unit's energy output. This allows the unit to deliver the required amount of heated energy and nothing more.

Burner

Constructed of high grade stainless steel, the burner uses pre-mixed air and gas and provides a wide range of firing rates.

Condensate System with Built-In Neutralizing Cartridge

This is a condensing high efficiency water heater, and therefore has a condensate removal system. Condensate is nothing more than water vapor, derived from combustion products and similar to an automobile when it is initially started. It is very important that the condensate line slopes away from the water heater and down to a suitable inside drain.

The Built-In Neutralizing Cartridge is filled with marble chips that neutralize the condensate before it flows into a local drain. The marble chips dissolve over time. The cartridge is designed to be easily removed, refilled with marble chips, and reinstalled,

If the condensate outlet on the heater is lower than the drain, you must use a condensate removal pump. In addition, local authorities may require a condensate neutralizer to neutralize the condensate.

It is also very important not to expose the condensate line to freezing temperatures or any type of blockage. Plastic tubing must be the only material used for the condensate line. Steel, brass, copper or other materials will be subject to corrosion or deterioration. A second vent may be necessary to prevent condensate line vacuum lock on a long horizontal run. Also, an increase in pipe size may be necessary to allow condensate to drain properly. Support of the condensation line may be necessary to avoid blockage of the condensate flow.

Spark Ignition

The burner flame is ignited by applying high voltage to the system spark electrode. This causes a spark from electrode to ground.

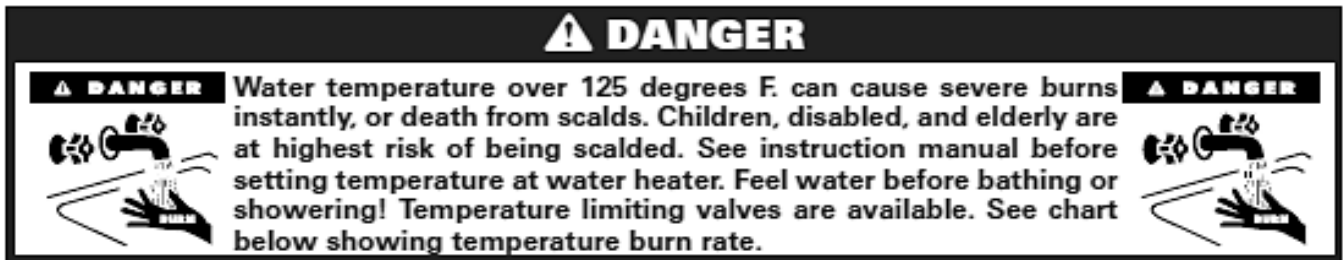

C. OPTIONAL EQUIPMENT

Below is a list of optional equipment available from Westinghouse:

- 2" PVC Concentric Vent Kit (Part # KGAVT0501CVT)
- 3" PVC Concentric Vent Kit (Part # KGAVT0601CVT)
- Outdoor Sensor (Part # 7250P-319)
- Condensate Neutralizer Replacement (Part # 7700P-026)

PART 3 – PREPARE WATER HEATER LOCATION

CAUTION

Carefully consider installation when determining heater location. Please read the entire manual before attempting installation. Failure to properly take factors such as heater venting, piping, condensate removal, and wiring into account before installation could result in wasted time, money, and possible property damage and personal injury.

A. BEFORE LOCATING THE HEATER

WARNING

Incorrect ambient conditions can lead to damage to the heating system and put safe operation at risk. Ensure that the heater installation location adheres to the information included in this manual. Failure to do so could result in property damage, serious personal injury, or death.

CAUTION

Failure of heater or components due to incorrect operating conditions IS NOT covered by product warranty.

1. Installation Area (Mechanical Room) Operating Conditions

- Ensure ambient temperatures are higher than 32°F/0°C and lower than 104°F/40°C.
- Prevent the air from becoming contaminated by the products, places, and conditions listed in this manual, Part 3, Section F.
- Avoid continuously high levels of humidity
- Never close existing ventilation openings
- Ensure a minimum 1" clearance around hot water and exhaust vent pipes
- **NOTE:** To prevent condensing in the fan, it is recommended to avoid prolonged exposure to temperatures below 45°F.

WARNING

This water heater has a condensate disposal system that may freeze if exposed to sustained temperatures below 32°F. Precautions should be taken to protect the condensate trap and drain lines from sustained freezing conditions. Failure to take precautions could result in property damage, severe personal injury, or death.

CAUTION

The service life of the heater's exposed metallic surfaces, such as the casing, as well as internal surfaces, such as the heat exchanger, are directly influenced by proximity to damp and salty marine environments. In such areas, higher concentration levels of chlorides from sea spray coupled with relative humidity can lead to degradation of the heat exchanger and other heater components. In these environments, heaters must not be installed using direct vent systems which draw outdoor air for combustion. Such heaters must be installed using room air for combustion. Indoor air will have a much lower relative humidity and, hence, potential corrosion will be minimized.

WARNING

This heater is certified for indoor installations only. Do not install the heater outdoors. Failure to install this heater indoors could result in substantial property damage, severe personal injury, or death.

2. Check for nearby connections to:

- System water piping
- Venting connections
- Gas supply piping
- Electrical power
- Condensate drain

3. Check area around heater. Remove any combustible materials, gasoline, and other flammable liquids.

WARNING

Failure to keep heater area clear and free of combustible materials, liquids, and vapors can result in substantial property damage, severe personal injury, or death.

4. Gas control system components must be protected from dripping water during operation and service.

5. If the heater is to replace an existing heater, check for and correct any existing system problems, such as:

- System leaks

- Location that could cause the system and heater to freeze and leak.
- Incorrectly-sized expansion tank

6. Clean and flush system when reinstalling a heater.

NOTE: When installing in a zero clearance location, it may not be possible to read or view some product labeling. It is recommended to make note of the heater model and serial number.

B. LEVELING

⚠ CAUTION

In order for the condensate to properly flow out of the collection system, the area where you locate the heater must be level. Location must also fully support the weight of the filled water heater.

C. CLEARANCES FOR SERVICE ACCESS

CAUTION

All water heaters eventually leak. It is recommended to install a catch pan beneath the water heater. This catch pan should be sized with a maximum depth of 2", and a minimum diameter 2" greater than the diameter of the water heater. The catch pan should empty into an open drain line. This drain line should be 3/4" ID minimum, piped to an open drain. Failure to follow these instructions could result in property damage. Such damages ARE NOT covered by product warranty.

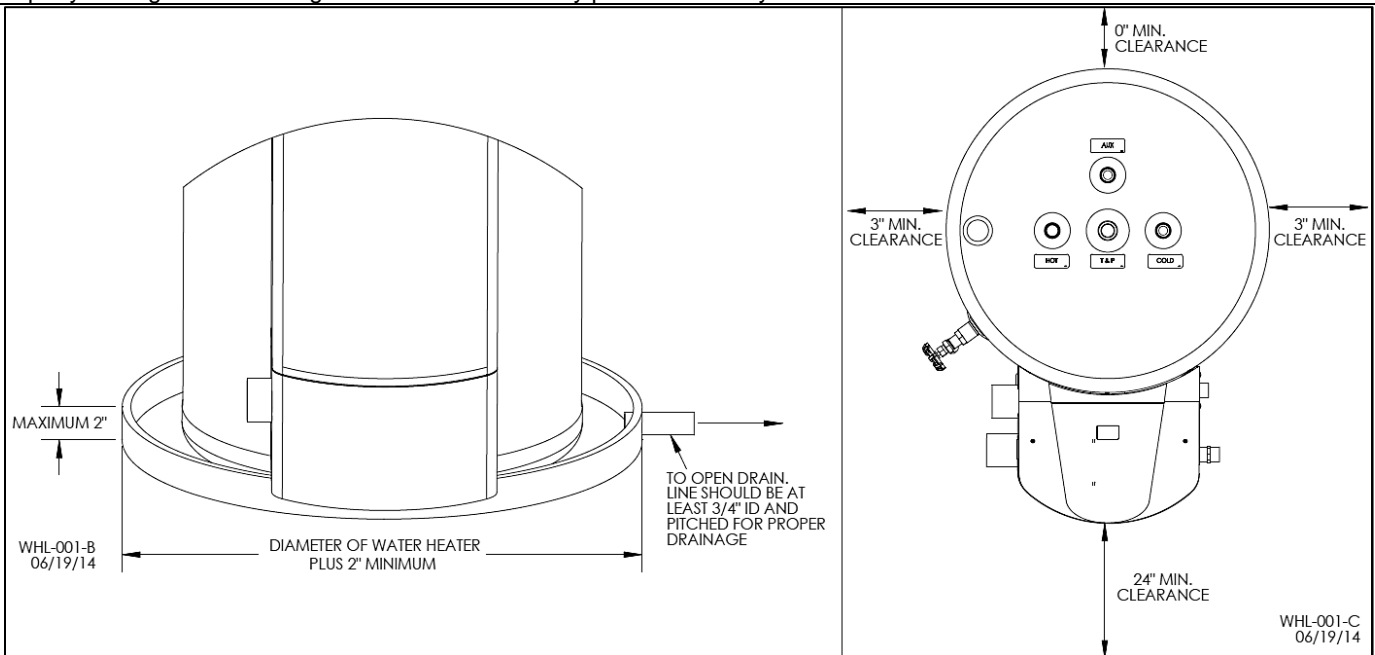

Figure 1 – Recommended Service Clearances

NOTE: In addition, it is recommended to provide a minimum service clearance of 6" from the top of the water heater to allow for piping of the T&P relief valve and top ports. Depending on the installation, this clearance may need to be substantially greater than 6".

NOTE: If you do not provide the minimum clearances shown in Figure 1, it might not be possible to service the heater without removing it from the space.

⚠ WARNING

The space must be provided with combustion/ventilation air openings correctly sized for all other appliances located in the same space as the heater. The heater cover must be securely fastened to prevent the heater from drawing air from the heater room. This is particularly important if the heater is in a room with other appliances. Failure to comply with the above warnings could result in substantial property damage, severe personal injury, or death.

D. RESIDENTIAL GARAGE INSTALLATION

PRECAUTIONS

If the heater is located in a residential garage, per ANSI Z223.1:

- Mount the bottom of the heater a minimum of 18" above the floor of the garage, to ensure the burner and ignition devices are well off the floor.

- When raising the heater, fully support the entire bottom of the water heater.
- Locate or protect the heater so it cannot be damaged by a moving vehicle.

E. EXHAUST VENT AND INTAKE PIPE

The heater is rated ANSI Z21.10.3 Category IV (pressurized vent, likely to form condensate in the vent) and requires a special vent system designed for pressurized venting.

NOTE: The venting options described here (and further detailed in Venting, Part 5 in this manual) are the lone venting options approved for this water heater. Failure to vent the water heater in accordance with the provided venting instructions will void the warranty.

DANGER

Failure to vent the water heater properly will result in serious personal injury or death.

WARNING

Do not attempt to vent this water heater by any means other than those described in this manual. Doing so will void the warranty, and may result in severe personal injury or death.

WARNING

Vents must be properly supported. Heater exhaust and intake connections are not designed to carry heavy weight. Vent support brackets must be within 1' of the heater and the balance at 4' intervals. Heater must be readily accessible for visual inspection for the first 3' from the heater.

WARNING

The exhaust discharged by this water heater may be very hot. Avoid touching or other direct contact with the exhaust gases or the vent termination assembly. Doing so may result in product damage, severe personal injury, or death.

1. DIRECT VENT INSTALLATION OF EXHAUST AND INTAKE

If installing a direct vent option, combustion air must be drawn from the outdoors directly into the water heater intake, and exhaust must terminate outside. There are three basic direct vent options detailed in this manual: 1. Side Wall Venting, 2. Roof Venting, and 3. Unbalanced Venting.

Be sure to locate the heater such that the exhaust vent and intake piping can be routed through the building and properly terminated. Different vent terminals can be used to simplify and eliminate multiple penetrations in the building structure (see Optional Equipment in Venting Section). The exhaust vent and intake piping lengths, routing and termination methods must all comply with the methods and limits given in the Venting section, Part 5 of this manual.

When installing a combustion air intake from outdoors, care must be taken to utilize uncontaminated combustion air. **To prevent combustion air contamination, see Table 1 – Contaminant Table.**

2. INDOOR COMBUSTION AIR INSTALLATION IN CONFINED OR UNCONFINED SPACE

This heater requires fresh, uncontaminated air for safe operation and must be installed in a mechanical room where there is adequate combustion and ventilating air. **NOTE: To prevent combustion air contamination, see Table 1 – Contaminant Table.**

Combustion air from the indoor space can be used if the space has adequate area or when air is provided through a duct or louver to supply sufficient combustion air based on the water heater input. **Never obstruct the supply of combustion air to the water heater.** If the water heater is installed in areas where indoor air is contaminated (see Table 1) it is imperative that the water heater be installed as direct vent so that all combustion air is taken directly from the outdoors into the water heater intake connection.

Unconfined space is space with volume greater than 50 cubic feet per 1,000 Btu/hour (4.8 cubic meters per kW) of the total input rating of all fuel-burning appliances installed in that space. Rooms connected directly to this space, through openings not furnished with doors, are considered part of the space. See **Figure 14**, p. 34 for details.

Confined space is space with volume less than 50 cubic feet per 1,000 Btu/hour (4.8 cubic meters per kW) of the total input rating of all fuel-burning appliances installed in that space. Rooms connected directly to this space, through openings not furnished with doors, are considered part of the space.

When drawing combustion air from inside a conventionally constructed building to a confined space, such space should be provided with two permanent openings: one located 6" (15 cm) below the space ceiling, the other 6" (15cm) above the space floor. Each opening should have a free area of one square inch per 1,000 Btu/hr (22cm²/kW) of the total input of all appliances in the space, but not less than 100 square inches (645cm²).

If the confined space is within a building of tight construction, air for combustion must be obtained from the outdoors as outlined in the Venting section, Part 5 of this manual.

CAUTION

When drawing combustion air from the outside into the mechanical room, care must be taken to provide adequate freeze protection.

⚠ WARNING

Do not attempt to vent this water heater by any means other than those described in this manual. Doing so will void the warranty, and may result in severe personal injury or death.

⚠ WARNING

Failure to provide an adequate supply of fresh combustion air can cause poisonous flue gases to enter living space, resulting in severe personal injury or death. To prevent combustion air contamination, see Table 1.

F. PREVENT COMBUSTION AIR CONTAMINATION

Install intake air piping for the heater as described in the Venting Section. Do not terminate exhaust in locations that can allow contamination of intake air.

⚠ WARNING

Ensure that the intake air will not contain any of the contaminants below. Contaminated air will damage the heater, resulting in possible substantial property damage, severe personal injury, or death. For example, do not pipe intake air near a swimming pool. Also, avoid areas subject to exhaust fumes from laundry facilities. These areas always contain contaminants.

PRODUCTS TO AVOID	AREAS LIKELY TO HAVE CONTAMINANTS
Spray cans containing fluorocarbons	Dry cleaning/laundry areas and establishments
Permanent wave solutions	Swimming pools
Chlorinated waxes/cleaners	Metal fabrication plants
Chlorine-based swimming pool chemicals	Beauty shops
Calcium chloride used for thawing	Refrigeration repair shops
Sodium chloride used for water softening	Photo processing plants
Refrigerant leaks	Auto body shops
Paint or varnish removers	Plastic manufacturing plants
Hydrochloric or Muriatic acid	Furniture refinishing areas and establishments
Cements and glues	New building construction
Antistatic fabric softeners used in clothes dryers	Remodeling areas
Chlorine-type bleaches, laundry detergents, and cleaning solvents	Garages and workshops
Adhesives used to fasten building products	

Table 1 – Contaminant Table

NOTE: DAMAGE TO THE HEATER CAUSED BY EXPOSURE TO CORROSIVE VAPORS IS NOT COVERED BY WARRANTY. (Refer to the limited warranty for complete terms and conditions).

G. REMOVING A HEATER FROM A COMMON VENT SYSTEM

⚠ DANGER

Do not install the heater into a common vent with any other appliance. This will cause flue gas spillage or appliance malfunction, resulting in possible substantial property damage, severe personal injury, or death.

⚠ WARNING

Failure to follow all instructions can result in flue gas spillage and carbon monoxide emissions, causing severe personal injury or death.

When removing an existing heater, follow the steps below.

1. Seal any unused openings in the common venting system.
2. Visually inspect the venting system for proper size and horizontal pitch to

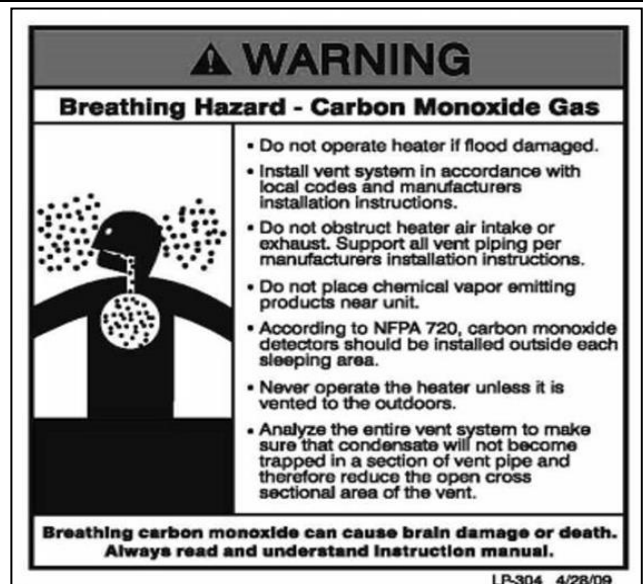

Figure 2 - CO Warning Label

determine if there is blockage, leakage, corrosion or other deficiencies that could cause an unsafe condition.

3. If practical, close all building doors, windows and doors between the space in which the water heater remains connected to the common venting system and other spaces in the building. Turn on clothes dryers and any appliances not connected to the common venting system. Turn on any exhaust fans, such as range hoods and bathroom exhausts, at maximum speed. Do not operate a summer exhaust fan. Close all fireplace dampers.
4. Place in operation the appliance being inspected. Follow the lighting instructions. Adjust the thermostat so the appliance will operate continuously.
5. Test for spillage at the draft hood relief opening after 5 minutes of main burner operation. Use the flame of a match or candle or smoke from a cigarette.
6. After it has been determined that each appliance remaining connected to common venting system properly vents when tested as outlined, return doors, windows, exhaust fans, fireplace dampers and any other gas burning appliance to their previous condition of use.
7. Any improper operation of the common venting system should be corrected to conform to the National Fuel Gas Code, ANSI Z223.1. When resizing any portion of the common venting system, the system should approach the minimum size as determined using the appropriate tables in Appendix G in the National Fuel Gas Code, ANSI Z 223.1.

H. WATER CHEMISTRY

CAUTION

Chemical imbalance of the water supply may affect efficiency and cause severe damage to the water heater and associated equipment. Westinghouse recommends having water quality professionally analyzed to determine whether it is necessary to install a water softener. It is important that the water chemistry on both the domestic hot water and central heating sides are checked before installing the water heater, as water quality will affect the reliability of the system. Failure of a heat exchanger due to lime scale build-up on the heating surface, low pH, or other chemical imbalance IS NOT covered by the warranty.

CAUTION

Operating temperatures above 135°F will further accelerate the build-up of lime scale on the heating surface and may shorten the service life of the water heater. Failure of a heat exchanger due to lime scale build-up on the heating surface, low pH, or other chemical imbalance IS NOT covered by the warranty.

Outlined below are water quality parameters which need to be met in order for the system to operate efficiently for many years.

Water Hardness

Water hardness is mainly due to the presence of calcium and magnesium salts dissolved in water. The concentration of these salts is expressed in mg/L, ppm, or grains per gallon as a measure of relative water hardness. Grains per gallon is the common reference measurement used in the U.S. water heater industry. Hardness expressed as mg/L or ppm may be divided by 17.1 to convert to grains per gallon. Water may be classified as very soft, slightly hard, moderately hard, or hard based on its hardness number. The minerals in the water precipitate out as the water is heated and cause accelerated lime scale accumulation on a heat transfer surface. This lime scale build-up may result in premature failure of the heat exchanger. Operating temperatures above 135°F will further accelerate the build-up of lime scale on the heating surface and may shorten the service life of the water heater.

Water that is classified as hard and very hard must be softened to avoid heat exchanger failure. See below for further information about water hardness.

CLASSIFICATION	MG/L OR PPM	GRAINS/GAL
Soft	0 – 17.1	0 - 1
Slightly Hard	17.1 – 60	1 – 3.5
Moderately Hard	60 – 120	3.5 – 7.0
Hard	120 – 180	7.0 – 10.5
Very Hard	180 and over	10.5 and over

If the hardness of the water exceeds the maximum level of 7 grains per gallon, water should be softened to a hardness level no lower than 5 grains per gallon. Water softened as low as 0 to 1 grain per gallon may be under-saturated with respect to calcium carbonate, resulting in water that is aggressive and corrosive.

pH of Water

pH is a measure of relative acidity, neutrality or alkalinity. Dissolved minerals and gases affect water pH. The pH scale ranges from 0 to 14. Water with a pH of 7.0 is considered neutral. Water with a pH lower than 7 is considered acidic. Water pH higher than 7 is considered alkaline. A neutral pH (around 7) is desirable for most potable water applications. **Corrosion damage and heater failures resulting from water pH levels of lower than 6 or higher than 8 ARE NOT covered by the warranty.** The ideal pH range for water used in a storage tank or a water heater system is 7.2 to 7.8.

Total Dissolved Solids

Total Dissolved Solids (TDS) is a measurement of all minerals and solids dissolved in a water sample. The concentration of total dissolved solids is usually expressed in parts per million (ppm).

Water with a high TDS concentration will greatly accelerate lime and scale formation in the hot water system. Most high TDS concentrations precipitate out of the water when heated. This can generate a scale accumulation on the heat transfer surface that will greatly reduce the service life of a water heater. This scale accumulation can also impede the ability of the heat exchanger to transfer heat into the water. A heat exchanger damaged or blocked by lime/scale accumulation must be replaced.

The manufacturer of the water heater has no control of water quality, especially TDS levels in your system. Total dissolved solids in excess of 2,000 ppm will accelerate lime and scale formation in the heat exchanger. Heat exchanger failure due to total dissolved solids in excess of 2,000 ppm is a non-warrantable condition. **Failure of a water heater due to lime scale build up on the heating surface IS NOT covered by the warranty.**

Hardness: 7 grains

Chloride levels: 100 ppm

pH levels: 6-8

TDS: 2000 ppm

Sodium: 20 mGL

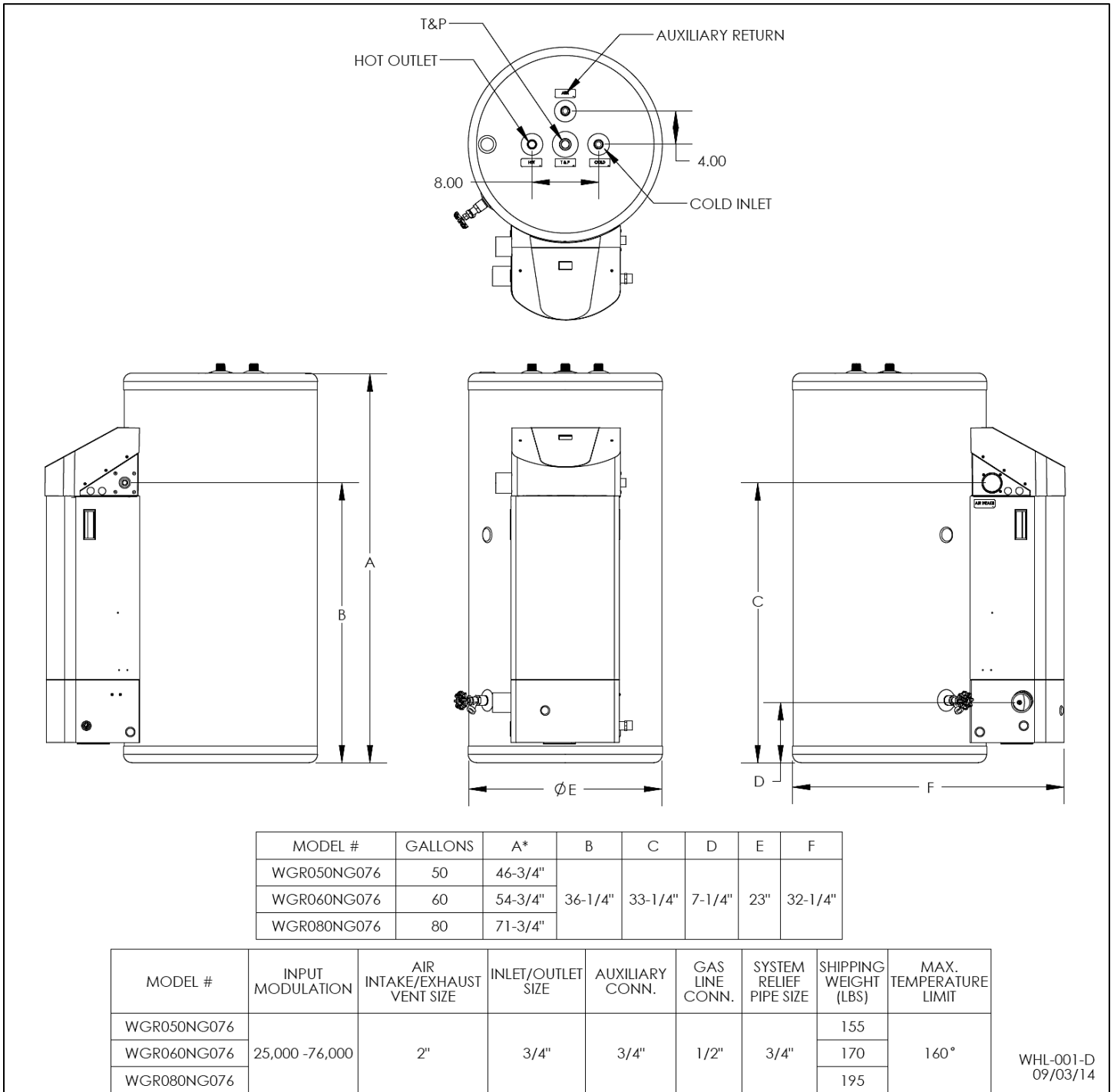

Figure 3 – *ALL DIMENSIONS ARE APPROXIMATE

⚠ WARNING

UNCRATING HEATER – Any claims for damage or shortage in shipment must be filed immediately against the transportation company by the consignee.

⚠ CAUTION

COLD WEATHER HANDLING – If the heater has been stored in a very cold location (BELOW 0°F) before installation, handle with care until the plastic components come to room temperature.

Remove all sides of the shipping crate to allow the heater to be lifted into its installation location.

PERFORMANCE SPECIFICATIONS FOR HIGH EFFICIENCY WATER HEATER MODELS													
BTUH	Efficiency	Temperature Rise in Degrees Fahrenheit											
		(°F)	40	50	60	70	80	90	100	110	120	130	140
76,000	97%	(°C)	22	28	33	39	44	50	56	61	67	72	78
		GPH	231	187	158	135	119	107	97	86	79	73	69
		LPH	874	708	598	511	450	405	367	326	299	276	261

Table 2 – Recovery on rating plate is based at 97% thermal efficiency at 70° Fahrenheit rise, as required by ANSI

PART 4 – HEATER PIPING

WARNING

Failure to follow the instructions in this section WILL VOID the warranty and may result in property damage, serious injury, or death.

CAUTION

Never use dielectric unions or galvanized steel fittings when connecting to a stainless steel storage tank or heater. Use only copper or brass fittings. Teflon thread sealant must be used on all connections.

CAUTION

DO NOT pipe this water heater with black iron, galvanized steel, steel, or lead pipe. Doing so will result in premature product failure and property damage, and WILL VOID the product warranty.

CAUTION

Do not apply heat to the Hot or Cold water heater connections. If sweat connections are used, sweat tubing to the adapter before fitting adapter to the water connections on the heater. Any heat applied to the water heater connections will permanently damage the dip tube and/or heat traps. Damages due to improper installation practices ARE NOT covered by warranty.

A. GENERAL PIPING INFORMATION

CAUTION

Use two wrenches when tightening water piping at heater. Use one wrench to prevent the heater return or supply line from turning. Failure to prevent piping connections from turning could cause damage to heater components.

CAUTION

The heater control module uses temperature sensors to provide both high limit protection and modulating temperature control. The control module also provides low water protection by sensing the water level in the tank. Some codes/jurisdictions may require additional external controls.

NOTICE

Installing the Optional High Output Cold Water Dip Tube – For longer hot water draw, remove the factory installed dip tube from the cold water inlet and replace with the Optional High Output Cold Water Dip Tube. This can be done by hand.

B. SCALDING

APPROXIMATE TIME / TEMPERATURE RELATIONSHIPS IN SCALDS	
120°F	More than 5 minutes
125°F	1 ½ to 2 minutes
130°F	About 30 seconds
135°F	About 10 seconds
140°F	Less than 5 seconds
145°F	Less than 3 seconds
150°F	About 1 ½ seconds
155°F	About 1 second

Table 3

This heater can deliver scalding water. Be careful whenever using hot water to avoid scalding injury. Certain appliances, such as dishwashers and automatic clothes washers may require increased water temperature. By setting the thermostat on this heater to obtain the increased water temperature required by these appliances, you may create the potential for scald injury.

To protect against injury, you should install a mixing valve in the water system. This valve will reduce point of discharge temperature by mixing cold and hot water in branch supply lines. Such valves are available from your local plumbing supplier.

Table 3 details the relationship of water temperature and time with regard to scald injury and may be used as a guide in determining the safest water temperature for your applications.

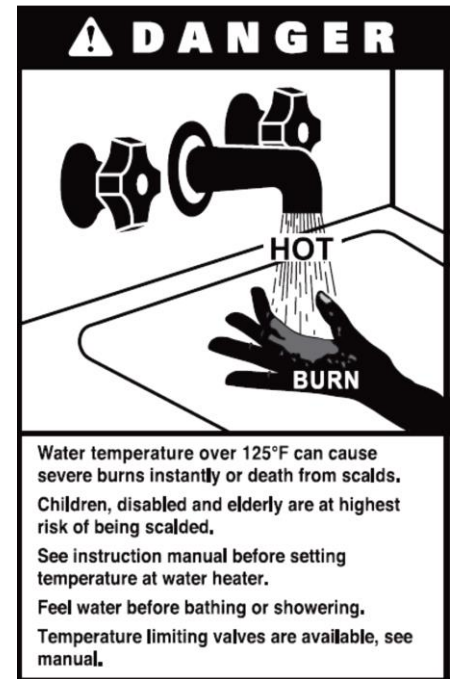

C. TEMPERATURE AND PRESSURE RELIEF VALVE

⚠ WARNING

Overheated water and high pressures can cause water tank explosion. A properly sized temperature and pressure relief valve must be installed in the opening provided on the water heater. Failure to install a properly sized temperature and pressure relief valve could result in explosion and property damage, serious injury, or death.

⚠ WARNING

To avoid water damage or scalding due to relief valve operation:

- Discharge line must be connected to relief valve outlet and run to a safe place of disposal. Terminate the discharge line in a manner that will prevent possibility of severe burns or property damage should the relief valve discharge.
- Discharge line must be as short as possible and the same size as the valve discharge connection throughout its entire length.
- Discharge line must pitch downward from the valve and terminate at least 6" above the floor drain, making discharge clearly visible.
- The discharge line shall terminate plain, not threaded, with a material serviceable for temperatures of 375°F or greater.
- Do not pipe discharge to any location where freezing could occur.
- No shutoff valve may be installed between the relief valve and heater or in the discharge line. Do not plug or place any obstruction in the discharge line.
- Test the operation of the relief valve after filling and pressurizing the system by lifting the lever. Make sure the valve discharges freely. If the valve fails to operate correctly, immediately replace with a new properly rated relief valve.
- Test T&P valve at least once annually to ensure the waterway is clear. If valve does not operate, turn the heater "off" and call a plumber immediately.
- Take care whenever operating relief valve to avoid scalding injury or property damage.

FAILURE TO COMPLY WITH THE ABOVE GUIDELINES COULD RESULT IN FAILURE OF RELIEF VALVE OPERATION, RESULTING IN POSSIBILITY OF SUBSTANTIAL PROPERTY DAMAGE, SEVERE PERSONAL INJURY, OR DEATH.

⚠ WARNING

Do not thread a cap or plug into the relief valve under any circumstances! Explosion and property damage, serious injury, or death may result.

D. BACKFLOW PREVENTER

Use a backflow preventer specifically designed for water heater installations. This valve should be installed on the cold water fill supply line per local codes.

E. POTABLE EXPANSION TANK

A potable hot water expansion tank is required to offset heated water expansion. In most city plumbing systems, the water meter has a no return or back flow device built into the system to prevent back flowing of water into city mains. Some local codes require back flow

preventers on all incoming water supplies. The hot water expansion tank must be listed for potable water use. The expansion tank should be located on the cold inlet piping close to the water heater.

EXPANSION TANK AND MAKE-UP WATER

1. Ensure that the expansion tank is sized to correctly handle heater and system water volume and temperature.

CAUTION

Undersized expansion tanks cause system water to be lost from the relief valve, causing make-up water to be added. Eventual heater failure can result due to excessive make-up water addition. **SUCH FAILURE IS NOT COVERED BY WARRANTY.**

2. The expansion tank must be located as shown in the Heater Piping Details, or following recognized design methods. See expansion tank manufacturer's instructions for details.

⚠ CAUTION

The expansion tank must be suitable for hot potable water.

F. WATER PIPING

⚠ CAUTION

Never use dielectric unions or galvanized steel fittings on any domestic water or auxiliary connections. Use only copper or brass fittings. Thread sealant must be used on all connections.

CAUTION

Do not apply heat to the water heater connections. If sweat connections are used, sweat tubing to the adapter before fitting adapter to the water connections on the heater. Any heat applied to the water heater connections will permanently damage the dip tube and/or heat traps. Damages due to improper installation practices ARE NOT covered by warranty.

The domestic water connections must be installed in accordance to all local and national plumbing codes, or any applicable standard which prevails. The inlet (cold) and outlet (hot) ports are $\frac{3}{4}$ " on all models.

It is recommended to install a sweat shut off valve and a union in the cold inlet piping and hot outlet to ease future servicing. If there is a back flow preventer or any type of a no return valve in the system, you must install an additional tee here, suitable for a potable hot water expansion tank.

In the hot outlet, install a suitable adapter to match the copper tubing of the plumbing system. A thermal trap or heat trap loop may be installed here to provide additional energy savings and prevent the thermal siphoning of domestic hot water.

G. AUXILIARY CONNECTIONS

The auxiliary connections are additional connections for a recirculation connection, air handlers, plate exchangers, or other devices that supply hot water. These connections must be installed in accordance with all local and national codes or any applicable standard that prevails. Auxiliary connections are $\frac{3}{4}$ " on all models. Never use dielectric unions or galvanized steel fittings. Use only copper or brass fittings. Sealant must be used on all connections.

⚠ WARNING

Never connect auxiliary connections to any system that uses glycol or other solutions formulated for hydronic systems. These auxiliary connections are to be used only in a potable water system. Failure to follow this warning could result in serious injury or death.

H. FILLING THE HEATER

⚠ WARNING

When filling the water heater, open a hot water tap to release air in the tank and piping. The tank must be full of water before the heater is turned on. Failure to ensure the water heater is full before turning it on will result in damage to the water heater, and could result in property damage, serious personal injury, or death. Such damages ARE NOT covered by water heater warranty.

- Make certain that the field installed drain valve is completely closed.
- Open the shut-off valve in the cold water supply line.
- Open the hot water faucets to allow air to vent from the heater and piping.
- Allow sufficient time for the heater to completely fill with water.

⚠ WARNING

The water heater must be full of water and the system fully purged BEFORE powering the water heater. Applying power to the water heater when it is not full of water could result in a condition referred to as “dry-firing”. Dry-firing the water heater will damage the heat exchanger, and could result in property damage, serious personal injury, or death. Such damages ARE NOT covered by water heater warranty.

I. IMPORTANT NOTICE

NOTICE

It is extremely important that whenever work is performed on the plumbing system that either:

- The water heater is powered off, or,
- The water heater is valved off and isolated from the plumbing system.

Failure to take these measures could result in a dry-firing condition.

⚠ WARNING

The water heater must be full of water and the system fully purged BEFORE powering the water heater. Performing any work in the plumbing system without either powering off the water heater or isolating the water heater through the use of shut-off valves could result in a condition referred to as “dry-firing”. Dry-firing the water heater will damage the heat exchanger, and could result in property damage, serious personal injury, or death. Such damages ARE NOT covered by water heater warranty.

J. PIPING DIAGRAMS

Figure 4 – High Efficiency Water Heater with Recirculation Line and Thermostatic Mixing Valve Piping

NOTES:

1. Minimum pipe size should match unit connection size. Upsize pipe accordingly if greater flow is required.
2. A thermal expansion tank suitable for potable water must be sized and installed within this piping system between the backflow preventer and the cold water inlet.
3. Gas line must be rated to the unit maximum input capacity. Unit must have 10 feet of pipe after gas regulator.
4. All circulators should have an integral flow check.
5. Drains and check valve between unit and storage tank will assist in purging air from system.
6. This drawing is meant to demonstrate system piping only. The installer is responsible for all equipment and detailing required by local codes. In Massachusetts, you must install a vacuum relief valve per 248 CMR.
7. Always shut off power to the water heater or isolate the heater from the system if ANY plumbing work is to be done. Running the water heater without water will result in dry firing.

⚠ DANGER

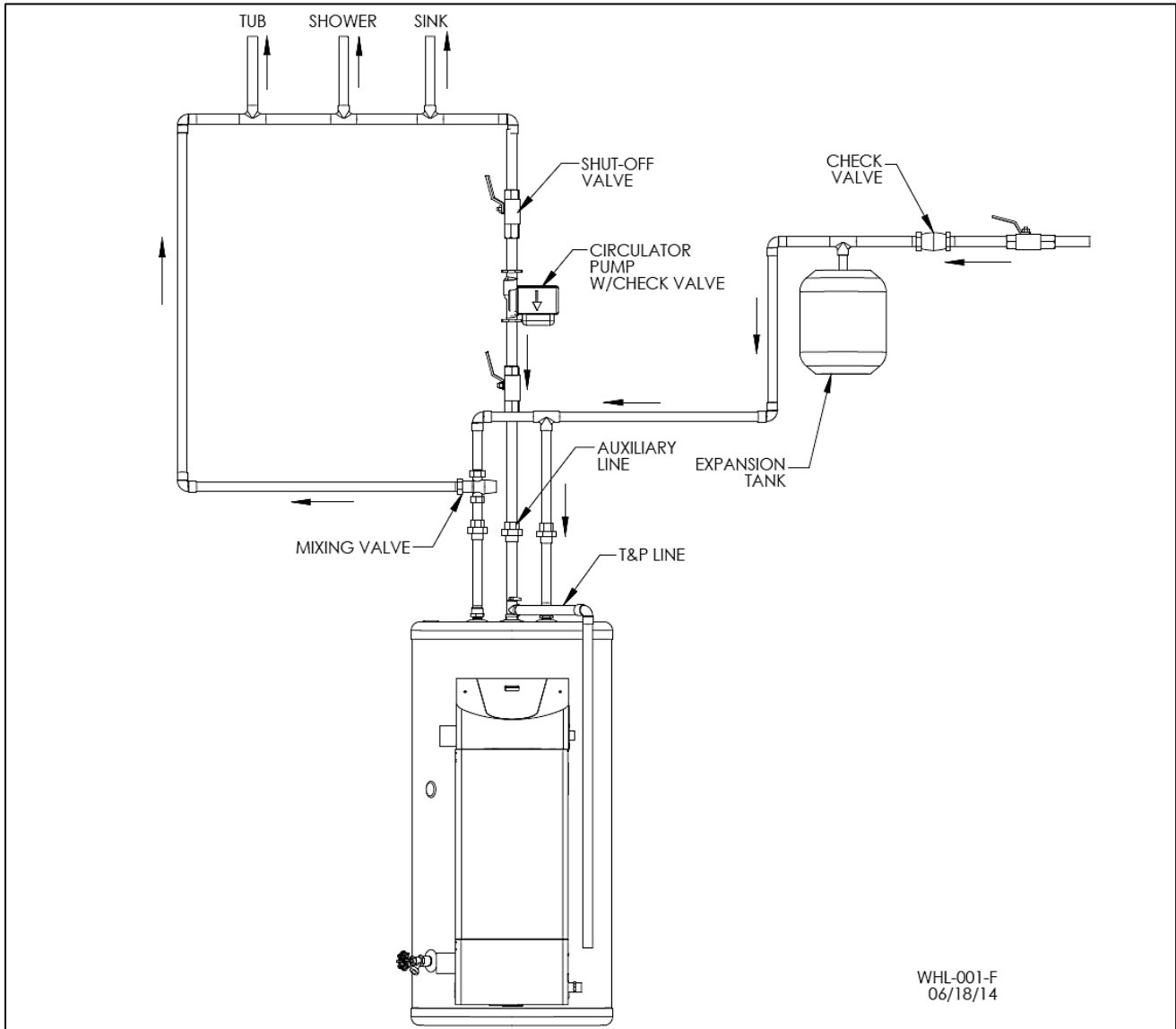
An ASSE 1017 thermostatic mixing valve **MUST** be installed when using outdoor reset. Failure to do so could result in substantial property damage, serious injury, or death.

⚠ WARNING

The piping will not support the weight of the water heater circulator pump. Refer to the pump manufacturer's installation instructions to properly support the circulator pump. Failure to comply with these instructions could result in substantial property damage, severe personal injury, or death.

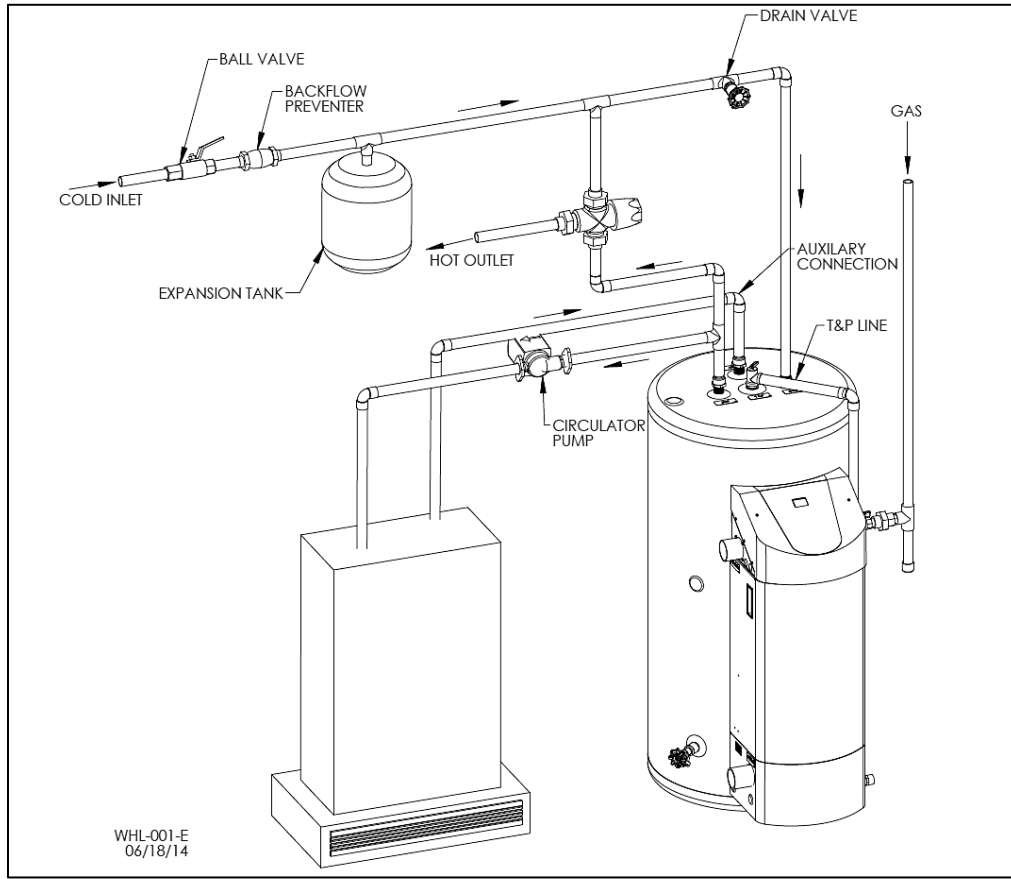

Figure 5 – High Efficiency Water Heater with Air Handler on Side

NOTES:

1. Minimum pipe size should match unit connection size. Upsize pipe accordingly if greater flow is required.
2. A thermal expansion tank suitable for potable water must be sized and installed within this piping system between the backflow preventer and the cold water inlet.
3. Gas line must be rated to the unit maximum input capacity. Unit must have 10 feet of pipe after gas regulator.
4. All circulators should have an integral flow check.
5. Check with air handler manufacturer for proper sizing.
6. This drawing is meant to demonstrate system piping only. The installer is responsible for all equipment and detailing required by local codes. In Massachusetts, you must install a vacuum relief valve per 248 CMR. With air handlers, outdoor reset is available with an outdoor sensor. See Part 8, Section D.
7. Always shut off power to the water heater or isolate the heater from the system if ANY plumbing work is to be done. Running the water heater without water will result in dry firing.

NOTES FOR AIR HANDLER APPLICATION:

1. MASSACHUSETTS STATE PLUMBING CODE REQUIRES A DISTANCE NO GREATER THAN 50 FEET FROM THE WATER HEATER TO THE FAN COIL IN THE AIR HANDLER.
2. MASSACHUSETTS STATE PLUMBING CODE REQUIRES AN ELECTRONICALLY TIMED CIRCULATOR PUMP TO ACTIVATE EVERY SIX HOURS FOR 60 SECONDS. THIS CIRCULATOR IS REQUIRED TO BE BRONZE OR STAINLESS.
3. ALL WATER PIPING MUST BE INSULATED.
4. YOU MUST INSTALL A VACUUM RELIEF VALVE PER 248 CMR.

NOTE: THIS DRAWING IS MEANT TO DEMONSTRATE SYSTEM PIPING ONLY. THE INSTALLER IS RESPONSIBLE FOR ALL EQUIPMENT AND DETAILING REQUIRED BY LOCAL CODES.

⚠ DANGER

An ASSE 1017 thermostatic mixing valve **MUST** be installed when using outdoor reset. Failure to do so could result in substantial property damage, serious injury, or death.

⚠ WARNING

The piping will not support the weight of the water heater circulator pump. Refer to the pump manufacturer's installation instructions to properly support the circulator pump. Failure to comply with these instructions could result in substantial property damage, severe personal injury, or death.

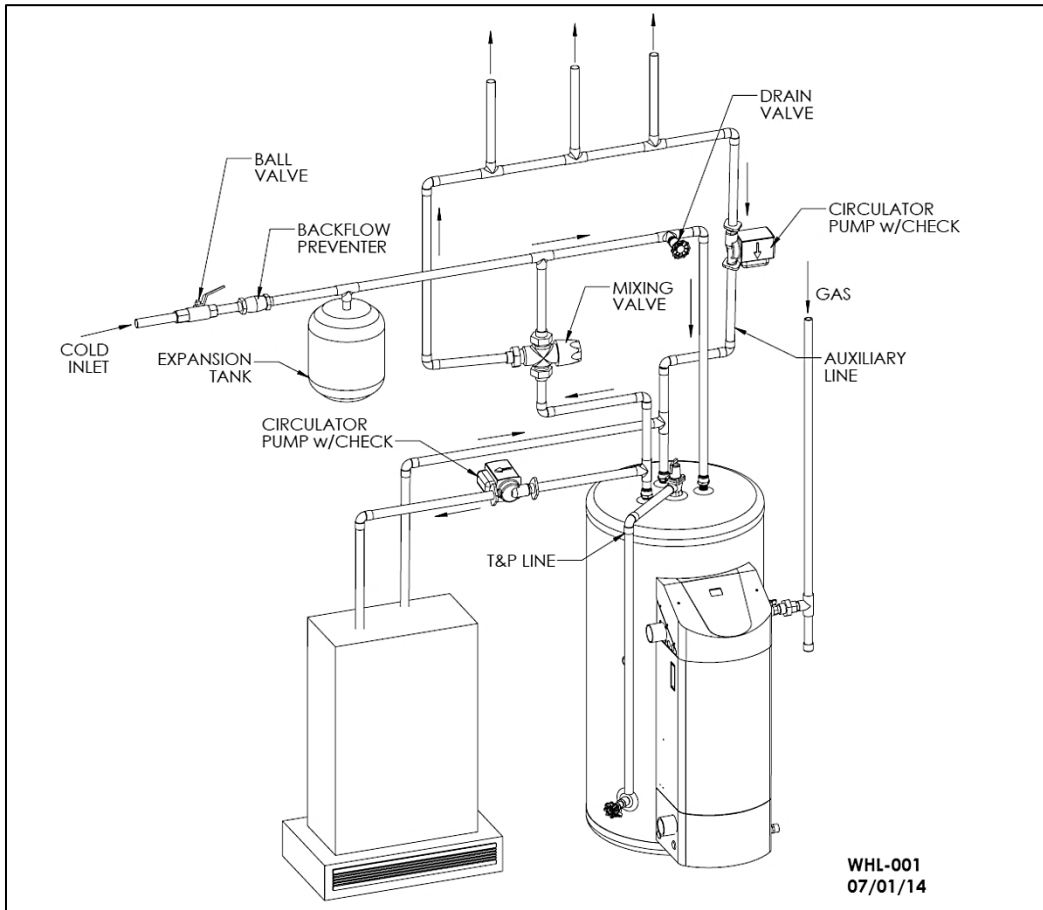

Figure 6 – High Efficiency Water Heater with Air Handler on Side

NOTES:

1. Minimum pipe size should match unit connection size. Upsize pipe accordingly if greater flow is required.
2. A thermal expansion tank suitable for potable water must be sized and installed within this piping system between the backflow preventer and the cold water inlet.
3. Gas line must be rated to the unit maximum input capacity. Unit must have 10 feet of pipe after gas regulator.
4. All circulators should have an integral flow check.
5. Check with air handler manufacturer for proper sizing.
6. This drawing is meant to demonstrate system piping only. The installer is responsible for all equipment and detailing required by local codes. In Massachusetts, you must install a vacuum relief valve per 248 CMR. With air handlers, outdoor reset is available with an outdoor sensor. See Part 8, Section D.
7. Always shut off power to the water heater or isolate the heater from the system if ANY plumbing work is to be done. Running the water heater without water will result in dry firing.

NOTES FOR AIR HANDLER APPLICATION:

1. MASSACHUSETTS STATE PLUMBING CODE REQUIRES A DISTANCE NO GREATER THAN 50 FEET FROM THE WATER HEATER TO THE FAN COIL IN THE AIR HANDLER.
2. MASSACHUSETTS STATE PLUMBING CODE REQUIRES AN ELECTRONICALLY TIMED CIRCULATOR PUMP TO ACTIVATE EVERY SIX HOURS FOR 60 SECONDS. THIS CIRCULATOR IS REQUIRED TO BE BRONZE OR STAINLESS.
3. ALL WATER PIPING MUST BE INSULATED.
4. YOU MUST INSTALL A VACUUM RELIEF VALVE PER 248 CMR.

NOTE: THIS DRAWING IS MEANT TO DEMONSTRATE SYSTEM PIPING ONLY. THE INSTALLER IS RESPONSIBLE FOR ALL EQUIPMENT AND DETAILING REQUIRED BY LOCAL CODES.

⚠ DANGER

An ASSE 1017 thermostatic mixing valve MUST be installed when using outdoor reset. Failure to do so could result in substantial property damage, serious injury, or death.

⚠ WARNING

The piping will not support the weight of the water heater circulator pump. Refer to the pump manufacturer's installation instructions to properly support the circulator pump. Failure to comply with these instructions could result in substantial property damage, severe personal injury, or death.

PART 5 – VENTING, COMBUSTION AIR AND CONDENSATE REMOVAL

⚠ DANGER

The heater must be vented as detailed in this Venting Section. Ensure exhaust vent and intake piping complies with these instructions regarding vent system. Inspect finished exhaust vent and intake piping thoroughly to ensure all joints are well secured, airtight, and comply with all applicable code requirements, as well as with the instructions provided in this manual. Failure to properly install the vent system will result in severe personal injury or death.

A. GENERAL

⚠ DANGER

This heater is certified as a “Category IV” appliance, and requires a special venting system. The vent system will operate with a positive pressure in the pipe. Exhaust gases must be piped directly outdoors using the vent materials and rules outlined in these instructions. Do not connect vent connectors serving appliances vented by natural draft into any portion of mechanical draft systems operating under positive pressure. Follow the venting instructions carefully. Failure to do so will result in substantial property damage, severe personal injury, or death.

1. Installation should be made in accordance with the regulations of the Authority Having Jurisdiction, local code authorities, and utility companies which pertain to this type of water heating equipment.

2. Install the venting system in accordance with these instructions and with the National Fuel Gas Code, ANSI Z223.1/NFPA 54, CAN/CGA B149, and/or applicable provisions of local building codes.

3. This water heater must be vented with materials, components, and systems listed and approved for Category IV appliances.

⚠ DANGER

Exhaust and intake are to be piped separately. This heater cannot share a common exhaust or intake with multiple appliances. Failure to follow this instruction will result in substantial property damage, severe personal injury, or death.

NOTE: To avoid contamination often contained in indoor air, it is best to pipe all intake combustion air directly to the outdoors.

NOTE: If exhaust vent pipe system passes through an unheated space, such as an alcove or attic, the space must be heated or the pipe must be insulated. The insulation must have an R value sufficient to prevent freezing of the condensate.

⚠ WARNING

Improper seating of vent pipe gaskets can cause eventual gasket failure and exhaust gas leakage. Ensure the exhaust vent pipe is properly beveled and seated before insertion into the flue adapter. Failure to do so could result in property damage, severe personal injury, or death.

⚠ DANGER

Due to the extreme flammability of most glues, cements, solvents, and primers used to join plastic exhaust vent and intake pipes, explosive solvent vapors must be cleared from all vent piping before start-up. Avoid using excess cement or primer, as this may pool in the vent pipes. Vent assemblies should be allowed to cure for a period of at least 8 hours before powering a connected appliance. Failure to follow these instructions will result in substantial property damage, severe personal injury, or death. It is the installers' responsibility to understand the hazards associated with explosive solvents and take the necessary precautions to avoid these risks.

⚠ WARNING

DO NOT insulate the first 3 feet of the Exhaust Vent. CPVC, Polypropylene, or Stainless Steel pipe material MUST be used for the first 3 feet of the vent run if the Exhaust Vent is insulated or passes through an enclosed space greater than 6", such as a wall. The balance of the vent run can be installed with standard Schedule 40 PVC pipe. Failure to comply with this warning could result in substantial property damage, severe personal injury, or death.

⚠ WARNING

Breathing Hazard - Carbon Monoxide Gas



- Do not operate heater if flood damaged.
- Install vent system in accordance with local codes and manufacturers installation instructions.
- Do not obstruct heater air intake or exhaust. Support all vent piping per manufacturers installation instructions.
- Do not place chemical vapor emitting products near unit.
- According to NFPA 720, carbon monoxide detectors should be installed outside each sleeping area.
- Never operate the heater unless it is vented to the outdoors.
- Analyze the entire vent system to make sure that condensate will not become trapped in a section of vent pipe and therefore reduce the open cross sectional area of the vent.

Breathing carbon monoxide can cause brain damage or death. Always read and understand instruction manual.

LP-304 4/28/09

B. APPROVED MATERIALS FOR EXHAUST VENT AND INTAKE PIPE

APPROVED EXHAUST VENT AND INTAKE PIPE MATERIAL			
Item	Material	Standards for Installation in:	
		United States	Canada
Exhaust vent or Intake pipe and fittings	PVC schedule 40/80	ANSI/ASTM D1785	PP, CPVC, and PVC venting must be ULC-S636 Certified. IPEX is an approved manufacturer in Canada, supplying vent material listed to ULC-S636.
	PVC-DWV*	ANSI/ASTM D2665	
	CPVC schedule 40/80	ANSI/ASTM F441	
	Polypropylene	ULCS636	
	Stainless Steel AL29-4C	Certified for Category IV and direct vent appliance venting	Certified for Category IV and direct vent appliance venting
Pipe cement/primer	PVC	ANSI/ASTM D2564	IPEX System 636 Cements & Primers
	CPVC	ANSI/ASTM F493	

Table 4

 DANGER

- The exhaust and intake components installed with this heater must be used for near heater piping BEFORE transitioning to the approved materials listed above. DO NOT REMOVE these installed components. Doing so WILL VOID heater warranty.
- PVC/CPVC pipe and fittings of the same diameter are considered interchangeable.
- DO NOT use Foam Core Pipe in any portion of the exhaust piping from this water heater.
- DO NOT connect PVC/CPVC to PP without an approved vent connector.
- When installing AL29-4C vent piping, install a PVC-to-stainless adapter at the heater vent connection, and at the termination when using a PVC termination kit. DO NOT mix AL-29-4C piping from different manufacturers unless using adapters specifically designed for the purpose by the manufacturer.
- A double wall vent may be used when using stainless steel vent material in a freezing climate.
- *PVC-DWV for air intake applications ONLY.
- Contact the venting material manufacturer if there is any question about the applicability of the proposed venting material. Failure to follow these directions will result in substantial property damage, severe personal injury, or death.

 WARNING

DO NOT mix components from different venting systems. The vent system could fail, causing leakage of flue products into the living space. Use only the approved pipe and fitting materials, and primer and cement specifically designed for the material used, as listed in Table 4. Failure to do so could result in property damage, severe personal injury, or death.

 WARNING

Exhaust vent adaptors are not designed as load-bearing devices, and must not be used to support exhaust vent piping. All vent pipes must be properly connected, supported, and the exhaust vent must be pitched a minimum of 1/4" per foot back to the heater to allow drainage of condensate. Failure to properly support vent piping and follow the information in this statement could result in product damage, severe personal injury, or death.

NOTE: The use of double-wall vent or insulated material for the combustion air inlet pipe is recommended in cold climates to prevent the condensation of airborne moisture in the incoming combustion air.

CAUTION

High heat sources (sources generating heat 100°F / 37°C or greater, such as stove pipes, space heaters, etc.) may damage plastic components of the water heater as well as plastic vent pipe materials. Such damages ARE NOT covered by warranty. It is recommended to keep a minimum clearance of 8" from high heat sources. Observe heat source manufacturer instructions, as well as local, state, provincial, and national codes, laws, regulations and ordinances when installing this water heater and related components near high heat sources.

C. REQUIREMENTS FOR INSTALLATION IN CANADA

1. Installations must be made with a vent pipe system certified to ULC-S636. IPEX is an approved vent manufacturer in Canada supplying vent material listed to ULC-S636. Additionally you may use AL29-4C stainless steel venting to comply with Canadian requirements.
2. The first three (3) feet of vent pipe from the water heater flue outlet must be readily accessible for visual inspection.
3. The components of the certified vent system must not be interchanged with other vent systems or unlisted pipe / fittings.

Cellular foam core piping may be used on air inlet piping **only**.

⚠ DANGER

You must not use "B" vent in an exhaust application. "B" vent is for intake applications **ONLY**. Using "B" vent in an exhaust application will result in serious injury or death.

D. EXHAUST VENT AND INTAKE PIPE LOCATION

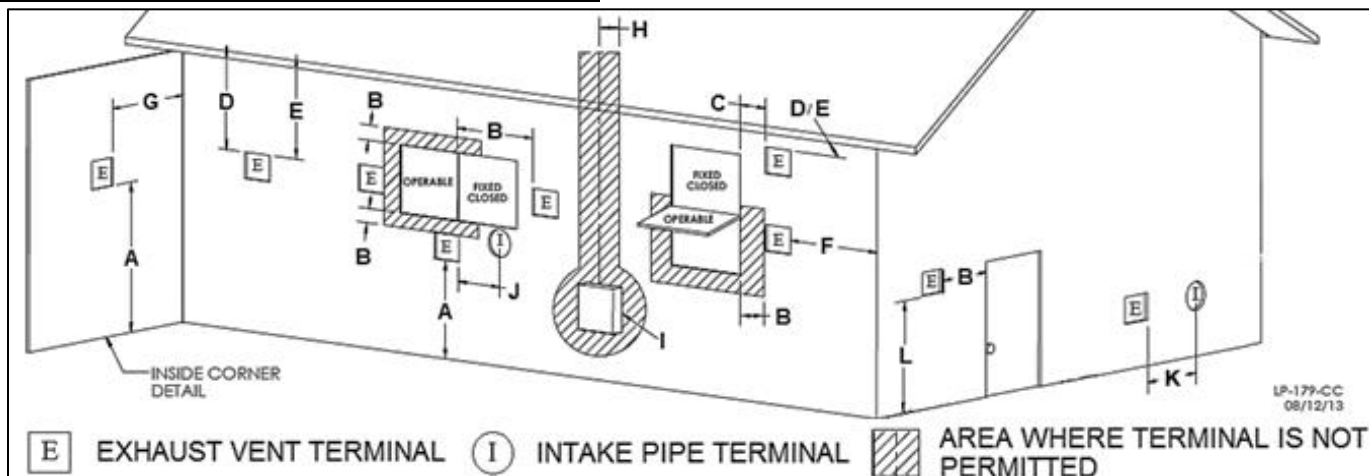

Figure 7 – ANSI Z223.1 / NFPA 54 for US and CAN/CSA B149.1 for Canada – Exit Terminals for Direct-Vent Venting Systems

DETERMINE EXHAUST VENT AND INTAKE PIPE LOCATION – FIGURE 7 NOTES: INSTALLATIONS IN THE UNITED STATES

- A.** Provide a minimum of 1 foot clearance from the bottom of the exhaust vent and intake pipe above the expected snow accumulation level. Snow removal may be necessary to maintain clearance.
- B.** Provide a minimum of 1 foot distance from exhaust vent termination to any door, operable window, or gravity intake into any building.
- C.** Provide a minimum of 1 foot distance from exhaust vent termination to any permanently closed door or window.
- D.** Provide a minimum of 4 feet vertical clearance from the exhaust vent to all roof overhangs.
- E.** Locating exhaust vent termination near roof overhangs will result in the formation of icicles in freezing weather, and could result in blockage of the exhaust vent. To prevent icicles from forming, maintain 4 feet vertical clearance from the exhaust vent to all roof overhangs.
- F.** Provide 4 feet clearance from the outside corner of vertical walls, chimneys, etc., as well as horizontal corners created by roof overhangs.
- G.** Provide 6 feet clearance from the inside corner of vertical walls, chimneys, etc., as well as horizontal corners created by roof overhangs.
- H.** Provide 4 feet clearance from center line within a height of 15 feet above electrical meters, gas meters, gas regulators, relief equipment, exhaust fans and inlets.
- I.** Provide 4 feet horizontal clearance from electrical meters, gas meters, gas regulators, relief equipment, exhaust fans and inlets. In no case shall the exit terminal be above or below the aforementioned equipment unless the 4 foot horizontal distance is maintained.
- J.** This water heater vent system shall terminate at least 3 feet (0.9 m) above any forced air intake located within 10 ft (3 m).
NOTE: This does not apply to the combustion air intake of a direct-vent appliance.
- K.** When venting with a two pipe system, maximum distance between exhaust vent and intake pipe is 6 feet (1.8 m). Minimum distance between exhaust vent and intake pipe on single direct vented appliance is 10" (0.255 m) center-to-center. Minimum distance between exhaust vents and intake pipes on multiple water heaters is 10" (0.255 m) center-to-center.
- L.** When adjacent to a public walkway, locate exit terminal at least 7 feet above grade.

In addition:

- Total length of vent piping shall not exceed the limits specified in this manual.
- The vent piping for this direct vented appliance is approved for zero clearance to combustible construction.
- The flue products coming from the exhaust vent will create a large plume when the boiler is in operation. Avoid venting in areas that will affect neighboring buildings or be considered objectionable.
- DO NOT locate exhaust vent or intake pipe in a parking area where machinery may damage the pipe.
- DO NOT locate the exhaust vent or intake pipe terminals under a porch, balcony, or veranda.
- Avoid terminating exhaust vents near shrubs, air conditioners, or other objects that will obstruct the exhaust stream.
- DO NOT vent over a public walkway. Condensate could drip or freeze and create a nuisance or hazard.
- **NOTE:** Due to potential moisture build-up, sidewall venting may not be the preferred venting option. Carefully consider venting installation and location to save time and cost.

INSTALLATIONS IN CANADA

NOTE: Canadian installation must comply with the CAN/CSA B149.1 code and applicable local codes and supersede the restrictions for the United States outlined in this section.

⚠ WARNING

The building owner is responsible for keeping the exhaust and intake terminations free of snow, ice, or other potential blockages, as well as scheduling routine maintenance. Failure to keep the vent piping terminations clear and properly maintain the heater could result in property damage, severe personal injury, or death.

⚠ WARNING

For each floor containing bedroom(s), a carbon monoxide detector and alarm shall be placed in the living area outside the bedrooms, as well as in the room that houses the heater. Detectors and alarms shall comply with NFPA 720 (latest edition). Failure to comply with requirements for detectors and alarms could result in property damage, severe personal injury, or death.

E. EXHAUST VENT AND INTAKE PIPE SIZING

1. The exhaust vent and intake pipe size is 2".
2. The total equivalent length of exhaust vent and intake pipe should **not exceed 150 feet**.
 - a. The equivalent length of elbows, tees, and other fittings are listed in the Friction Loss Table, Table 5:

FRICTION LOSS EQUIVALENT IN PIPING AND FITTINGS		
FITTINGS OR PIPING	EQUIVALENT FEET	
	2"	3"
90 DEGREE ELBOW*	5'	5'
45 DEGREE ELBOW	3'	3'
COUPLING	0'	0'
AIR INLET TEE	0'	0'
STRAIGHT PIPE	1'	1'
CONCENTRIC VENT KIT	3'	3'
V500 2" VENT KIT	1'	N/A
V1000 3" VENT KIT	N/A	1'
V2000 4" VENT KIT	N/A	1'

Table 5 - *Friction loss for long radius elbow is 1 foot less. NOTE: Consult Polypropylene venting instructions for friction loss and pressure drop equivalents.

- b. For example: If the exhaust vent has two 90° elbows and 10 feet of PVC pipe we will calculate:
 Exhaust Vent Equivalent Length = (2x5) + 10 = 20 feet.
 Further, if the intake pipe has two 90° elbows, one 45° elbow and 10 feet of PVC pipe, the following calculation applies:
 Intake Pipe Equivalent Length = (2x5) + 3 + 10 = 23 feet.
 Finally, if a concentric vent kit is used we find:
 Total Equivalent Length = 20 + 23 + 3 = 46 feet.
 The total equivalent length is 46 feet which is well below the maximum of 150 feet.
- c. The exhaust vent and intake pipe are intended to penetrate the same wall or roof of the building.
- d. Effort should be made to keep a minimum difference in equivalent length between the exhaust vent and intake pipe.

3. The minimum total equivalent length is 16 feet.

F. LONGER VENT RUNS

1. The maximum total equivalent length can be extended by increasing the diameter of both the exhaust vent and intake pipes. However, the transitions should begin a minimum of 15 equivalent feet from the water heater.
 - a. **The maximum total equivalent length for increased diameter vent pipes is 200 feet.**
 - b. Transitions should always be made in vertical sections of pipe to prevent the condensate from pooling in the vent pipe.

VENT CONNECTION	REDUCING COUPLING	VENT TRANSITION
2"	3" X 2"	3"

Table 6 – Vent Run Transition

- c. Transition from 2" to 3" pipe should be made at the water heater.

CAUTION

Do not exceed the maximum lengths for vent pipes. Excessive length could result in appliance shutdown and property damage.

G. EXHAUST VENT AND INTAKE PIPE INSTALLATION

⚠ WARNING

All joints of positive pressure vent systems must be sealed completely to prevent leakage of flue products into living space.

1. Use only solid PVC or CPVC pipe or a Polypropylene vent system approved for use with Category IV appliances.

FOAM CORE PIPING IS NOT APPROVED FOR EXHAUST VENT APPLICATIONS. Foam core piping may be used on air inlet piping **only**.

2. Remove all burrs and debris from joints and fittings.

3. When using PVC or CPVC pipe, all joints must be properly cleaned, primed, and cemented. Use only cement and primer approved for use with the pipe material. Cement must conform to ASTM D2564 for PVC and ASTM F493 for CPVC pipe. **NOTE: DO NOT CEMENT POLYPROPYLENE PIPE.**

4. Ensure the vent is located where it will not be exposed to prevailing winds.

5. In all roof venting applications, exhaust discharge must point away from the pitch of the roof.

6. To prevent water leakage, install adequate roof flashing where the pipe enters the roof.

7. Do not locate vent over public walkways, driveways, or parking lots. Condensate could drip and freeze, resulting in a slip hazard or damage to vehicles and machinery.

8. Due to potential moisture build-up, sidewall venting may not be the preferred venting option. To save time and cost, carefully consider venting installation and location.

9. Horizontal lengths of exhaust vent must slope back towards the water heater not less than ¼" per foot to allow condensate to drain from the vent pipe.

10. The exhaust vent must terminate where vapors cannot make accidental contact with people or pets, or damage shrubs or plants.

11. In vacant chimney applications, install and seal a rain cap over existing chimney openings.

12. All piping must be fully supported. Use pipe hangers at a minimum of 4 foot intervals to prevent sagging of the pipe where condensate may form.

13. Do not use the heater to support any piping.

14. A screened straight coupling is provided with the heater for use as an outside exhaust termination.

15. A screened inlet air tee is provided with the heater to be used as an outside intake termination.

Table 7 lists optional exhaust/intake terminations available from Westinghouse:

DESCRIPTION	STOCK CODE
2" PVC CONCENTRIC VENT TERMINATION KIT	KGAVT0501CVT
3" PVC CONCENTRIC VENT TERMINATION KIT	KGAVT0601CVT
2" STAINLESS STEEL VENT TERMINATION KIT	V500
3" STAINLESS STEEL VENT TERMINATION KIT	V1000

Table 7

H. VENTING DRAWINGS

1. DIRECT VENT INSTALLATION OF EXHAUST AND INTAKE

If installing a direct vent option, combustion air must be drawn from the outdoors directly into the water heater intake, and exhaust must terminate outside. There are three basic direct vent options detailed in this manual: 1. Side Wall Venting, 2. Roof Venting, and 3. Unbalanced Venting.

Be sure to locate the heater such that the exhaust vent and intake pipe can be routed through the building and properly terminated. Different vent terminals can be used to simplify and eliminate multiple penetrations in the building structure (see Optional Equipment in Venting Section). The exhaust vent and intake pipe lengths, routing and termination methods must all comply with the methods and limits given in the Venting section, Part 5 of this manual.

When installing a combustion air intake from outdoors, care must be taken to utilize uncontaminated combustion air. **NOTE: To prevent combustion air contamination, see Table 1 – Contaminant Table.**

⚠ WARNING

Take extra precaution to adequately support the weight of vent pipes terminating through the roof. Failure to properly support roof terminated vent piping could result in property damage, serious personal injury, or death due to flue gas leakage.

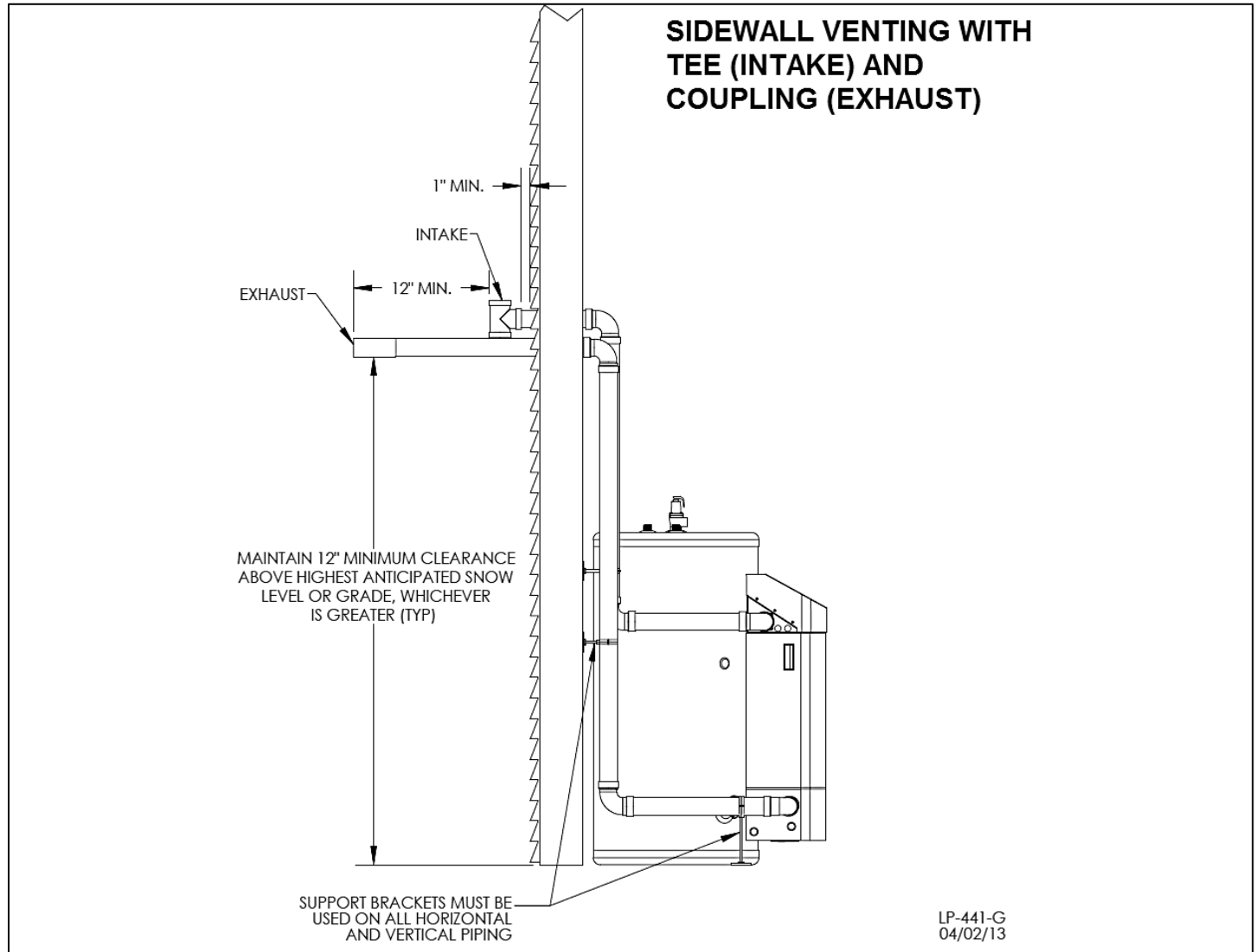

Figure 8 – Sidewall Venting with Tee (Intake) and Coupling (Exhaust) - NOTE: This drawing is meant to demonstrate system venting only. The installer is responsible for all equipment and detailing required by local codes.

⚠ WARNING

All vent pipes must be glued, properly supported, and the exhaust must be pitched a minimum of $\frac{1}{4}$ " per foot back to the heater to allow drainage of condensate. When placing support brackets on vent piping, the first bracket must be within 1 foot of the water heater and the balance at 4 foot intervals on the vent pipe. Heater venting must be readily accessible for visual inspection for the first three feet from the heater.

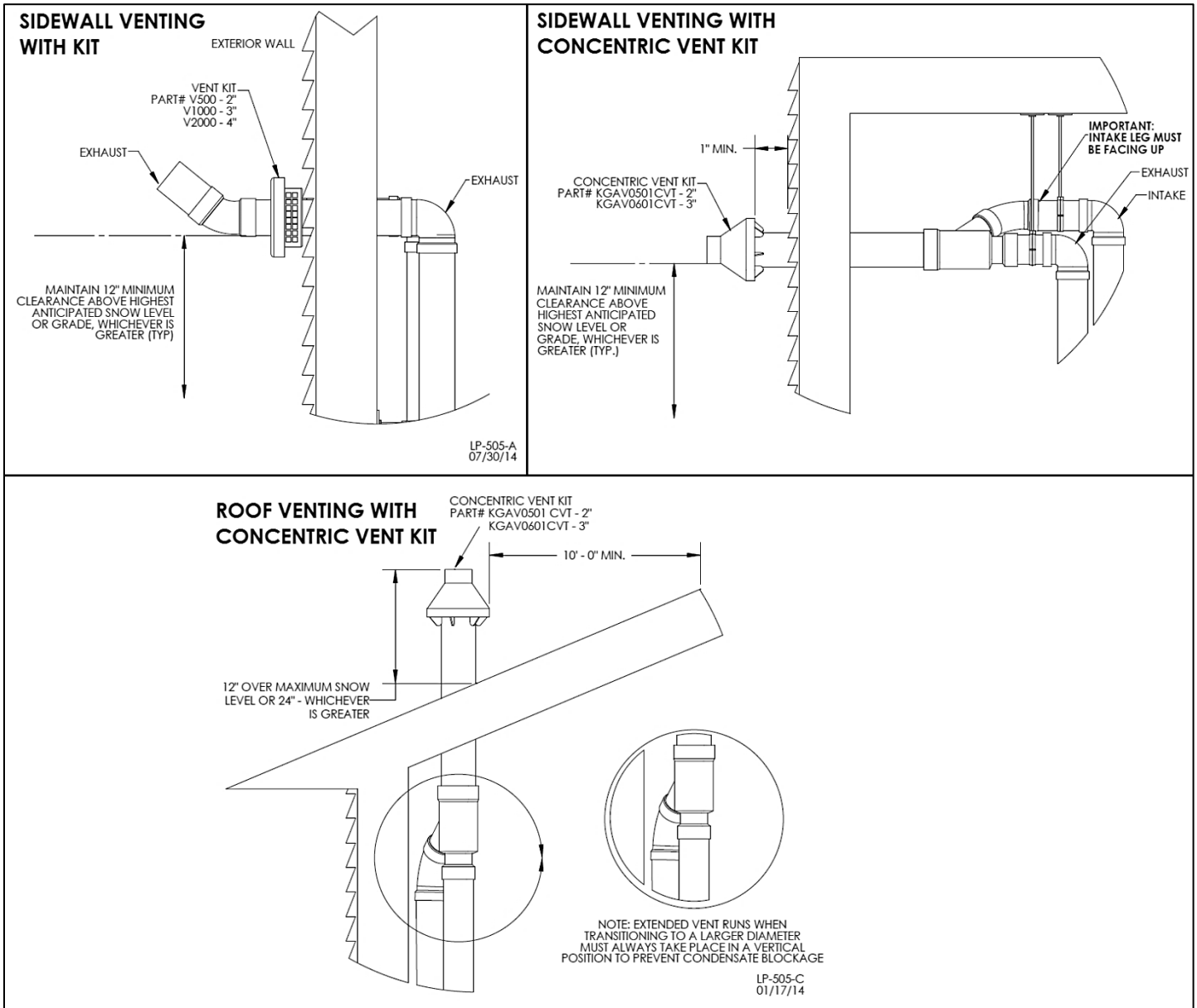

Figure 9 – Venting with Optional Kits (NOT INCLUDED WITH THE WATER HEATER) NOTE: These drawings are meant to demonstrate system venting only. The installer is responsible for all equipment and detailing required by local codes.

⚠ WARNING

All vent pipes must be glued, properly supported, and the exhaust must be pitched a minimum of 1/4" per foot back to the heater to allow drainage of condensate. When placing support brackets on vent piping, the first bracket must be within 1 foot of the water heater and the balance at 4 foot intervals on the vent pipe. Heater venting must be readily accessible for visual inspection for the first three feet from the heater.

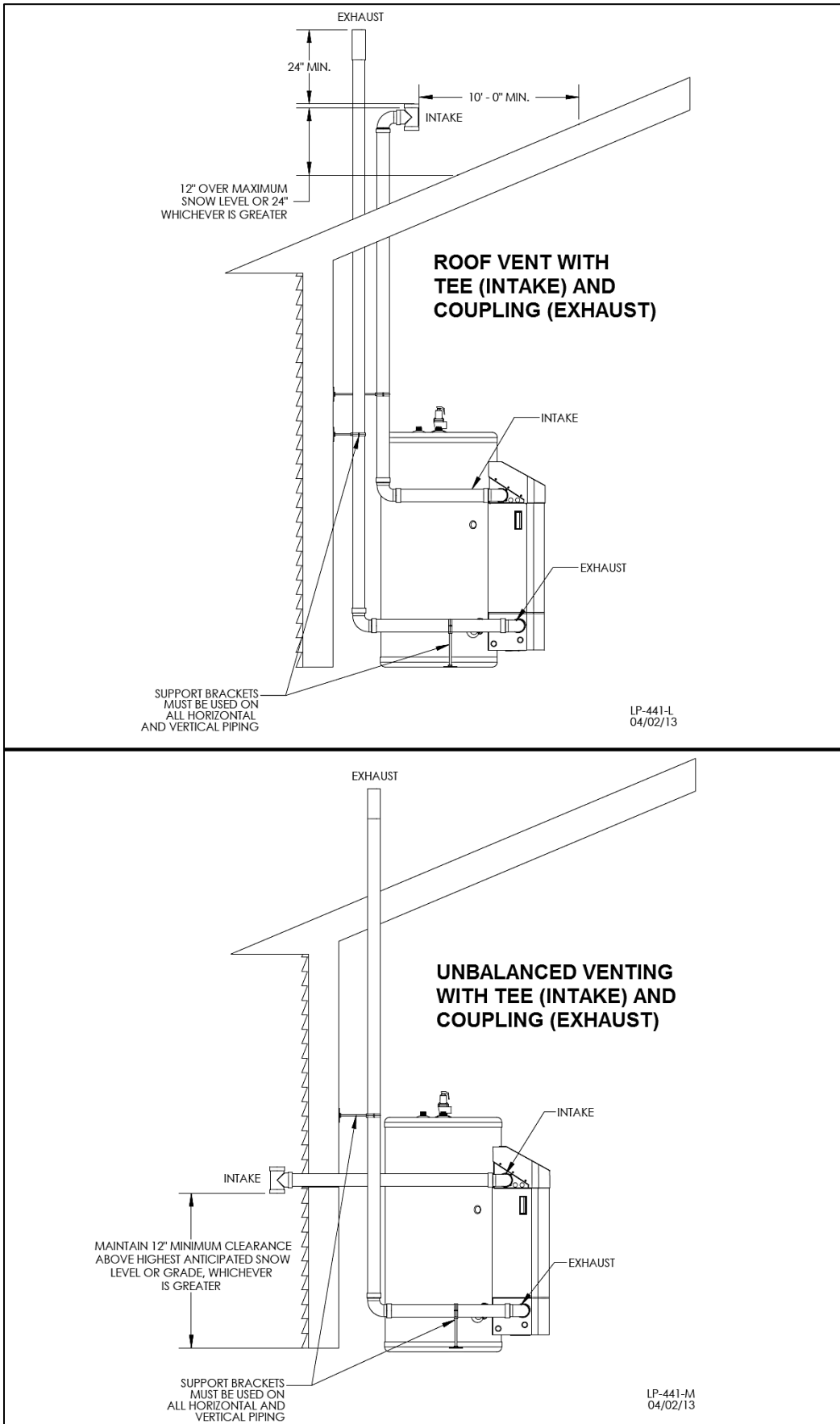

Figure 10 – NOTE: This drawing is meant to demonstrate system venting only. The installer is responsible for all equipment and detailing required by local codes.

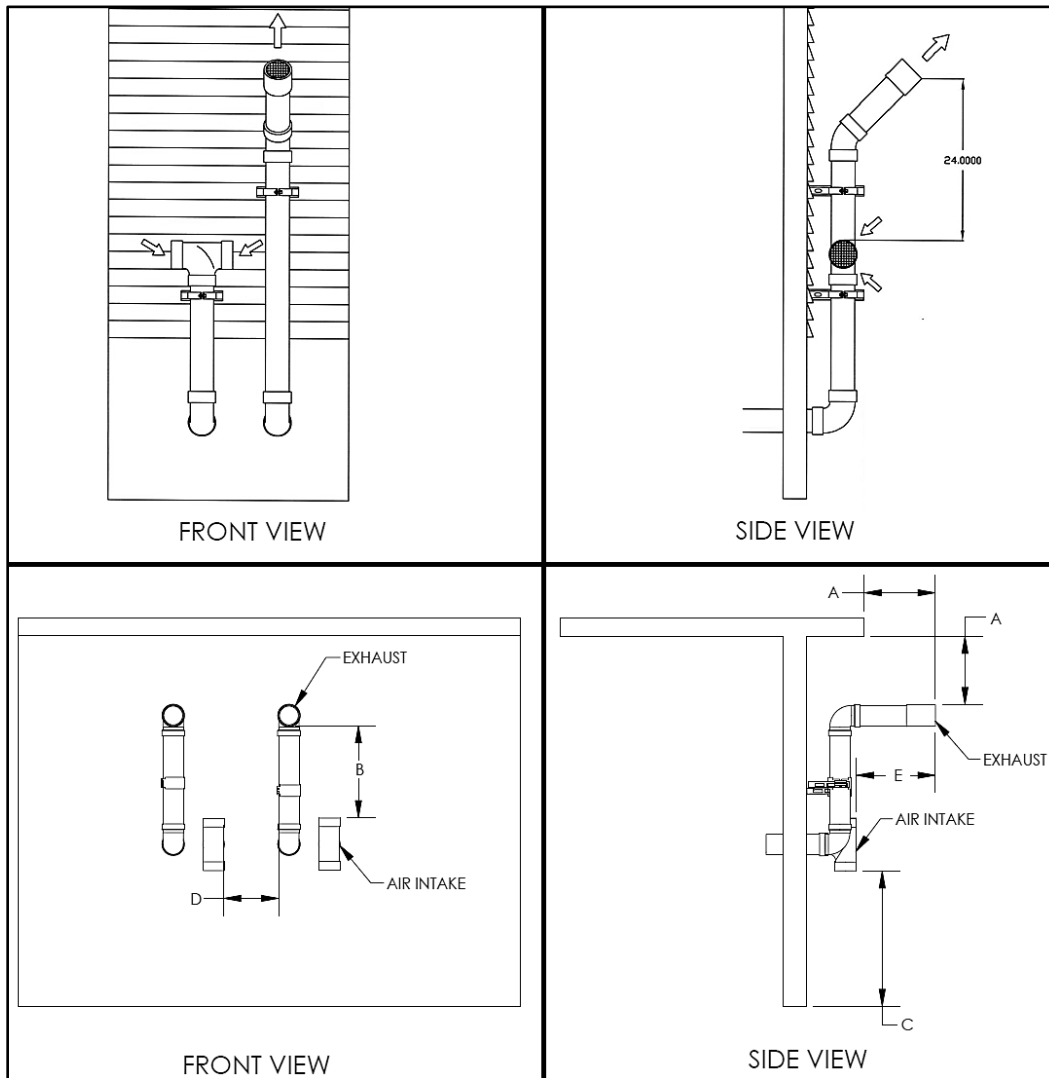

Figure 11 – Horizontal Venting - NOTE: This drawing is meant to demonstrate system venting only. The installer is responsible for all equipment and detailing required by local codes.

NOTES:

- A. For every 1" of overhang, the exhaust vent must be located 1" vertical below overhang (overhang means top of building structure and not two adjacent walls [corner of building]).
- B. Typical installations require 12" minimum separation between bottom of exhaust outlet and top of air intake.
- C. Maintain 12" minimum clearance above highest anticipated snow level or grade (whichever is greater).
- D. Minimum 12" between vents when installing multiple vents.
- E. 12" minimum beyond air intake.

⚠ WARNING

All vent pipes must be glued, properly supported, and the exhaust must be pitched a minimum of 1/4" per foot back to the heater to allow drainage of condensate. When placing support brackets on vent piping, the first bracket must be within 1 foot of the water heater and the balance at 4 foot intervals on the vent pipe. Heater venting must be readily accessible for visual inspection for the first three feet from the heater.

2. VENTING THROUGH AN EXISTING SYSTEM

This heater may be vented through an existing unused vent system. The inner diameter of the existing vent system is utilized for the combustion air source. Two methods have been approved for such venting: Concentric Venting Through an Existing System and Venting as a Chase.

VENT / AIR INLET SIZE	MINIMUM EXISTING VENT / CHASE SIZE
2"	4"
3"	5"
4"	7"

Table 8 – Minimum Existing Vent / Chase Sizing

! DANGER

Do not install the heater into a common existing vent with any other appliance. This will cause flue gas spillage or heater malfunction, resulting in substantial property damage, severe personal injury, or death.

CAUTION

Contractors must check state and local codes before installing through an existing vent opening. State and local codes always take precedence over manufacturer's instructions. Failure to check state and local codes before installing through an existing opening could result in property damage and add significantly to installation costs.

CAUTION

If an existing venting system is converted for use with this heater, the installer must ensure that the existing venting system is clean and free from particulate contamination that could damage the heater. Failure to do so could result in property damage and heater failure. Such failure IS NOT covered under warranty.

CONCENTRIC VENTING THROUGH AN EXISTING SYSTEM

NOTE: The following instructions refer only to venting through an existing vent system, and not to venting with HTP's optional concentric vent kits. Refer to Concentric Vent Kit installation manual (LP-166) for further information on venting with the optional concentric vent kits.

Concentric venting through an existing system must run vertically through the roof. See Table 5 for proper minimum vent sizing. Use only the approved venting materials specified in Table 4 for piping the system. All instructions listed in Part 5 - Venting apply. See Figures 12-1 and 12-2 for venting demonstrations.

! DANGER

The upper and lower vent terminations as well as all joints in the venting system must be properly sealed to ensure that all combustion air is drawn properly and exhaust does not leak from the system. Failure to properly seal the venting system will result in property damage, severe personal injury, or death.

CHASE VENTING THROUGH AN EXISTING SYSTEM

When venting as a chase, follow all instructions included in Part 5 – Venting of this manual, as well as the previous Concentric Venting section. See Figure 12-3 for chase venting demonstration.

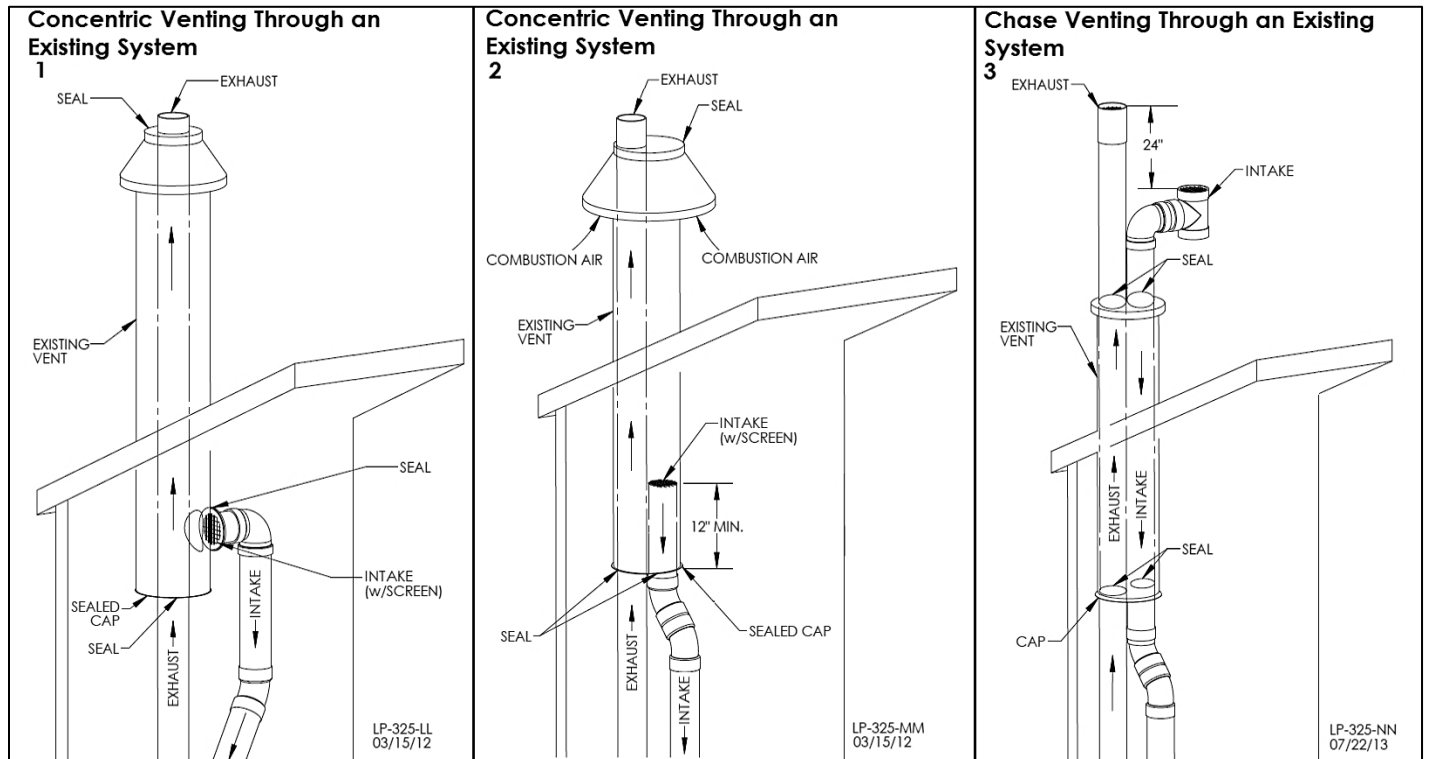

Figures 12 – 1, 12 – 2 Concentric Venting Through an Existing System, 12 – 3 Chase Venting Through an Existing System **NOTE:** This drawing is meant to demonstrate system venting only. The installer is responsible for all equipment and detailing required by local codes.

3. INDOOR COMBUSTION AIR INSTALLATION IN CONFINED OR UNCONFINED SPACE

This heater requires fresh, uncontaminated air for safe operation and must be installed in a mechanical room where there is adequate combustion and ventilating air. **NOTE: To prevent combustion air contamination, see Table 1 – Contaminant Table on page 12.**

Combustion air from the indoor space can be used if the space has adequate area or when air is provided through a duct or louver to supply sufficient combustion air based on the water heater input. **Never obstruct the supply of combustion air to the water heater.** If the water heater is installed in areas where indoor air is contaminated (see Figure 13) it is imperative that the water heater be installed as direct vent so that all combustion air is taken directly from the outdoors into the water heater intake connection.

Unconfined space is space with volume greater than 50 cubic feet per 1,000 Btu/hour (4.8 cubic meters per kW) of the total input rating of all fuel-burning appliances installed in that space. Rooms connected directly to this space, through openings not furnished with doors, are considered part of the space.

Confined space is space with volume less than 50 cubic feet per 1,000 Btu/hour (4.8 cubic meters per kW) of the total input rating of all fuel-burning appliances installed in that space. Rooms connected directly to this space, through openings not furnished with doors, are considered part of the space.

When drawing combustion air from inside a conventionally constructed building to a confined space, such space should be provided with two permanent openings: one located 6" (15 cm) below the space ceiling, the other 6" (15cm) above the space floor. Each opening should have a free area of one square inch per 1,000 Btu/hr (22cm²/kW) of the total input of all appliances in the space, but not less than 100 square inches (645cm²).

If the confined space is within a building of tight construction, air for combustion must be obtained from the outdoors as outlined in the Venting section of this manual. See Figure 14.

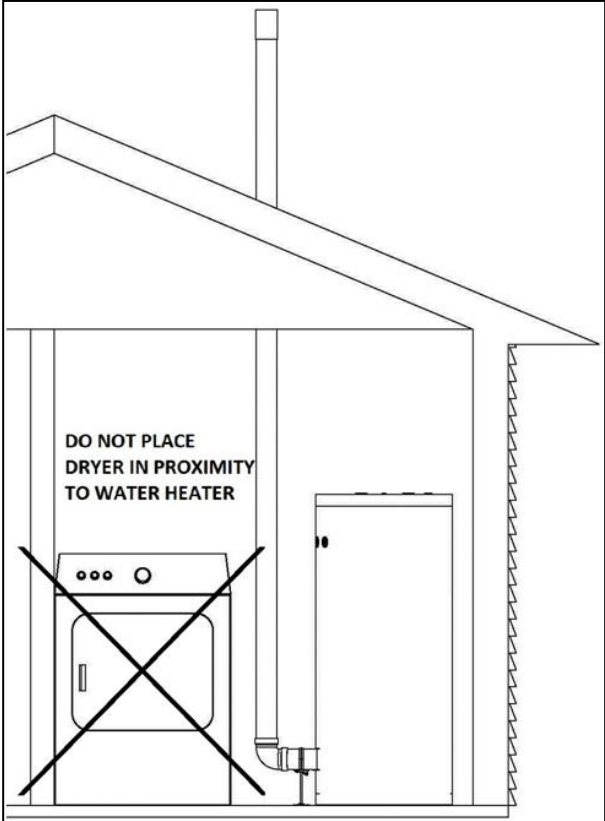
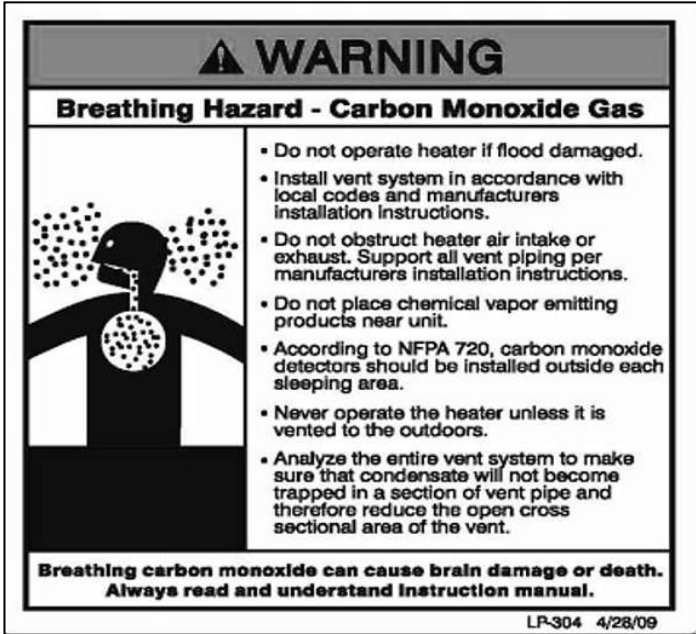

Figure 13 – LP-325-X

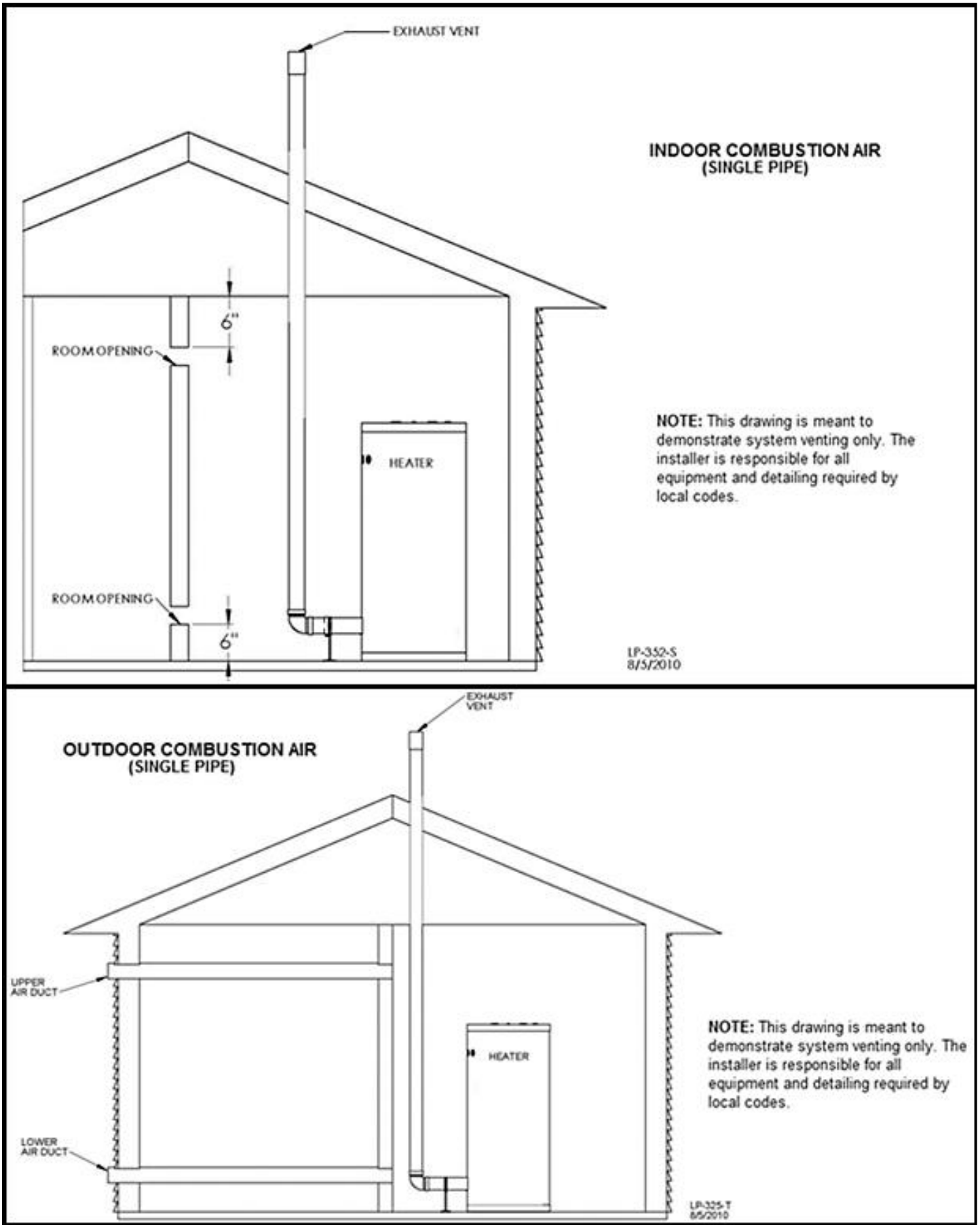

Figure 14

I. CONDENSATE REMOVAL SYSTEM

NOTE: Check with your local gas company to determine if combustion condensate disposal is permitted in your area. In the state of Massachusetts, condensate must be neutralized before entering a drain.

This condensing high efficiency water heater has a condensate removal system. Condensate is water vapor derived from combustion products, similar to that produced by an automobile when it is initially started. It is very important that the condensate line is sloped down away from the heater and to a suitable drain.

If the heater condensate outlet is lower than the drain, you must use a condensate removal. If required by local authorities, a condensate filter of lime crystals, marble, or phosphate chips will neutralize slightly acidic condensate.

CAUTION

The condensate line must remain unobstructed. If allowed to freeze in the line or obstructed in any other manner, condensate can exit from the water heater tee, resulting in potential water damage to property. When installing a condensate pump, select one approved for use with condensing heaters and furnaces. The condensate pump should have an overflow switch to prevent property damage from spillage. Condensate from the heater will be slightly acidic (pH from 3.2 to 4.5). Install a neutralizing filter if required by local codes.

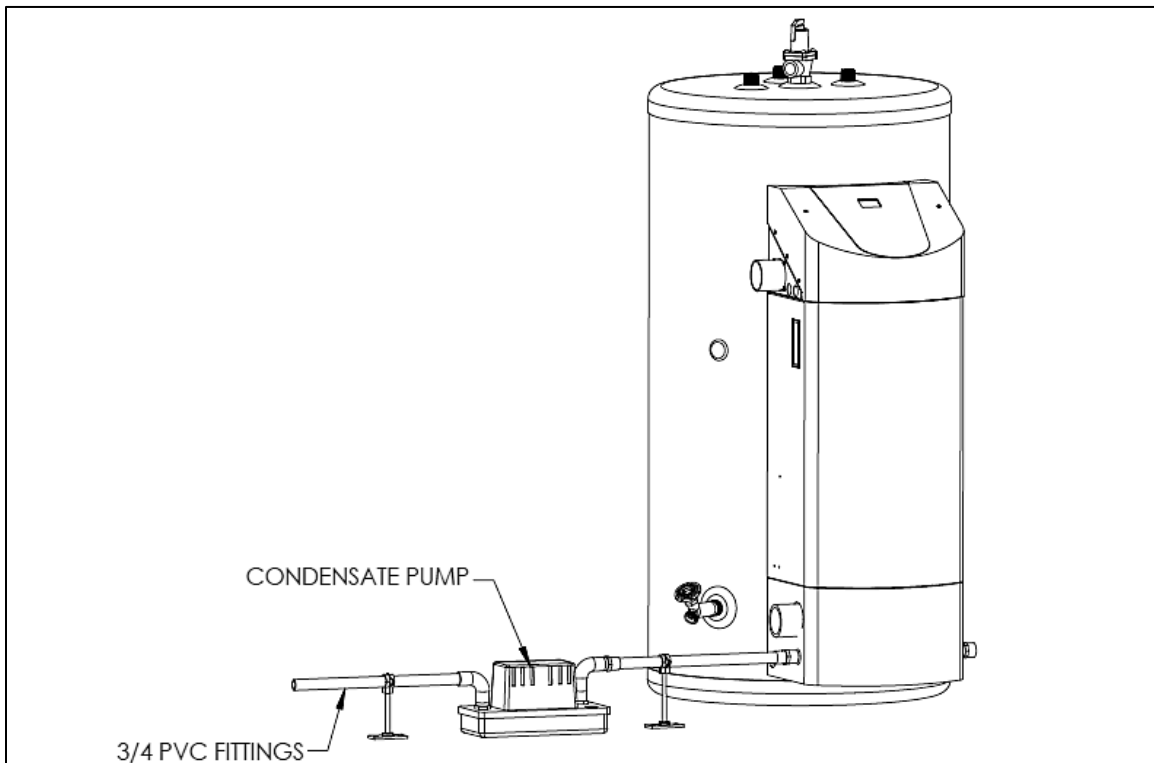

Figure 15 – Condensate Piping

NOTES:

1. Condensate line must be pitched at least $\frac{1}{4}$ " per foot to properly drain. If this cannot be done, or a very long length of condensate hose is used, increase the condensate line to a minimum of 1" ID and place a tee in the line after the condensate neutralizer to properly reduce vacuum lock in the drain line.
2. PVC or CPVC pipe should be the only material used for condensate line. Steel, brass, copper, and other metals will be subject to corrosion or deterioration.
3. A frozen condensate line could result in a blocked vent condition. It is very important to protect the condensate line from freezing temperatures or any type of blockage. In installations that may encounter sustained freezing conditions, the use of heat tape is recommended to avoid freezing of the condensate line. It is also recommended to bush up the condensate line size to 1" and terminate condensate discharge as close to the unit as possible. Longer condensate runs are more prone to freezing. Damages due to frozen or blocked condensate lines ARE NOT covered by warranty.
4. Support of the condensate line may be necessary to avoid blockage of the condensate flow.

⚠ WARNING

Power to the optional condensate pump is continuous. When the water heater is powered off the condensate pump will remain on. It is important to remember to turn off the condensate pump when powering down the water heater. Failure to do so could result in property damage, severe personal injury, or death.

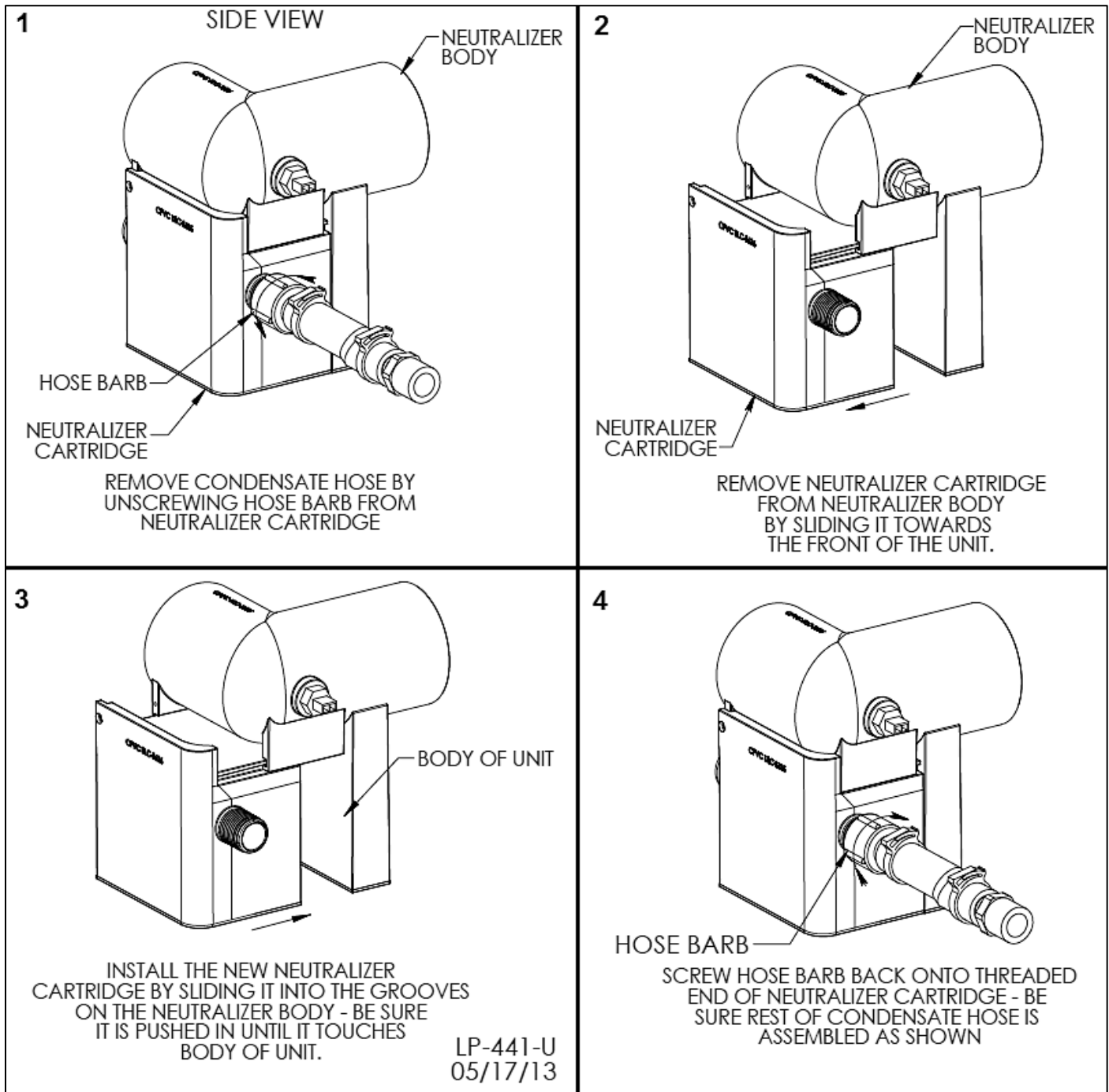

Figure 16 – Removing and Installing the Condensate Neutralizer

NOTICE

To ensure proper condensate neutralization it is recommended to check the condensate neutralizer cartridge every two years. Gently shake the cartridge to ensure it is still filled with neutralization media. Replace the condensate neutralizer cartridge if it is empty. Failure to do so could result in improper condensate neutralization. Please note that if not properly neutralized the slightly acidic condensate could corrode materials subject to corrosion (metals, concrete, stonework, etc.)

PART 6 – WIRING

⚠ WARNING

To avoid electrical shock, turn off all power to the heater prior to opening an electrical box within the unit. Ensure the power remains off while any wiring connections are being made. Failure to follow these instructions could result in component or product failure, serious injury, or death. Such product failure IS NOT covered by warranty.

⚠ WARNING

Jumping out control circuits or components WILL VOID product warranty and can result in property damage, personal injury, or death.

A. LINE VOLTAGE INPUT

The heater must be wired to a 115 volt circuit by a qualified electrician. It is recommended that the heater be wired on its own circuit to minimize the possibility of circuit failure due to outside causes. The heater requires a maximum of 8 amps at 120 volts in use.



Figure 17 – Line Voltage Wiring

B. LINE VOLTAGE CONDENSATE OUTPUT

The heater has the capability of supplying power to a condensate pump. The connection is 115 VAC + 10% / - 15% at a max of 2 amps. Power is supplied to the pump only when the heater is connected to power, and the power switch is in the on position.

C. LOW VOLTAGE OUTDOOR SENSOR INPUT

The heater has the capability of an outdoor reset. Connecting an outdoor sensor allows the heater to operate at optimum efficiency. Westinghouse offers an outdoor sensor.

The outdoor sensor must be a 12K NTC sensor. Use a minimum 22 AWG wire for runs of 100 feet or less and minimum 18 AWG wire for runs up to 150 feet. Instructions are included with the outdoor sensor to correctly mount the sensor on the exterior surface of the building. It is preferable to mount the sensor on the north side in an area that will not be affected by direct sunlight but will be exposed to varying weather conditions. Connect the outdoor sensor to terminals marked "Outdoor".

⚠ WARNING

It is of extreme importance that this unit be properly grounded. It is very important that the building system ground is inspected by a qualified electrician prior to making this connection. Electrical power must only be turned on when the heater is completely filled with cold water.

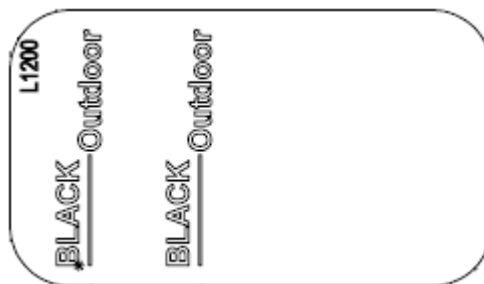

Figure 18 – Low Voltage Wiring

CAUTION

Label all wires prior to disconnecting them when servicing the heater. Wiring errors can cause improper and dangerous operation. Failure to follow these instructions may result in property damage or personal injury.

D. INTERNAL WIRING DIAGRAM

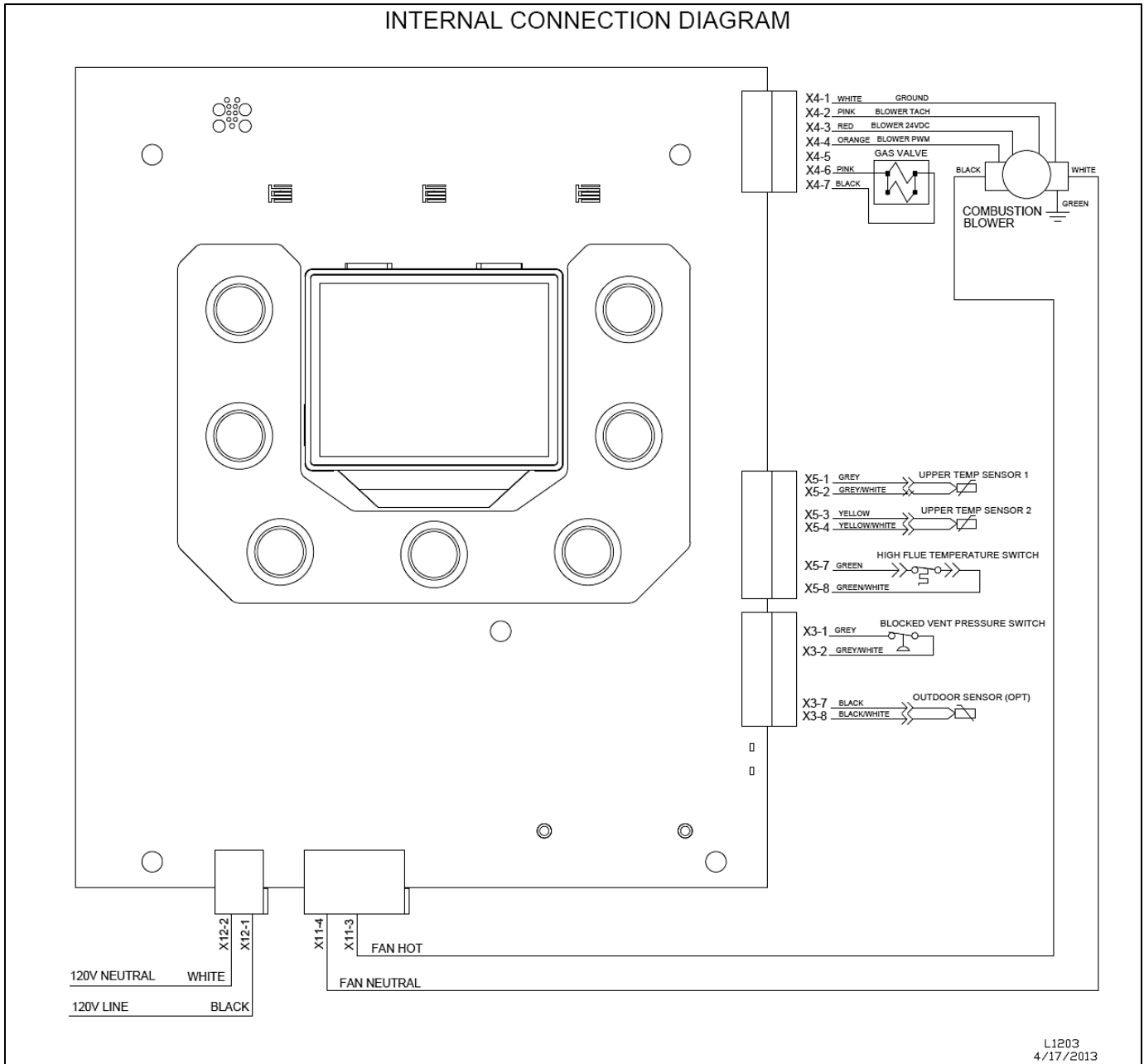

Figure 19 – Wiring Diagram

PART 7 – GAS CONNECTIONS

WARNING

Failure to follow all precautions could result in fire, explosion, severe injury or death!

WARNING

Ensure the gas on which the water heater will operate is the same type specified on the rating plate. Failure to do so could result in water heater malfunction, property damage, serious personal injury, or death.

The gas supply shall have a maximum inlet pressure of less than 14" water column (350 mm), ½ pound pressure (3.5 kPa), and a minimum of 3.5" water column. The entire piping system, gas meter and regulator must be sized properly to prevent pressure drop greater than 0.5" WC as stated in the National Fuel Gas Code. This information is listed on the rating plate.

It is very important that you are connected to the type of gas as noted on the rating plate: "LP" for liquefied petroleum, propane gas, or "Nat" for natural or city gas. All gas connections must be approved by the local gas supplier or utility, in addition to the governing authority, prior to turning the gas supply on.

Do not remove the adaptor in Figure 20! It is mandatory that this fitting is used for connection to a field fabricated drip leg per the National Fuel Gas Code. You must ensure that the entire gas line to the connection at the water heater is no smaller than ½".

Once all inspections have been performed, the piping must be leak tested. If the leak test requirement is a higher test pressure than the maximum gas inlet pressure, you must isolate the heater from the gas line to continue leak testing. To do this, you must turn off the factory and field-installed gas cocks. This will minimize the possibility of damaging the gas valve. Failure to do so may damage the gas valve. In the event the gas valve is exposed to a pressure greater than ½ PSI, 14" water column, the gas valve must be replaced. Never use an open flame (match, lighter, etc.) to check gas connections.

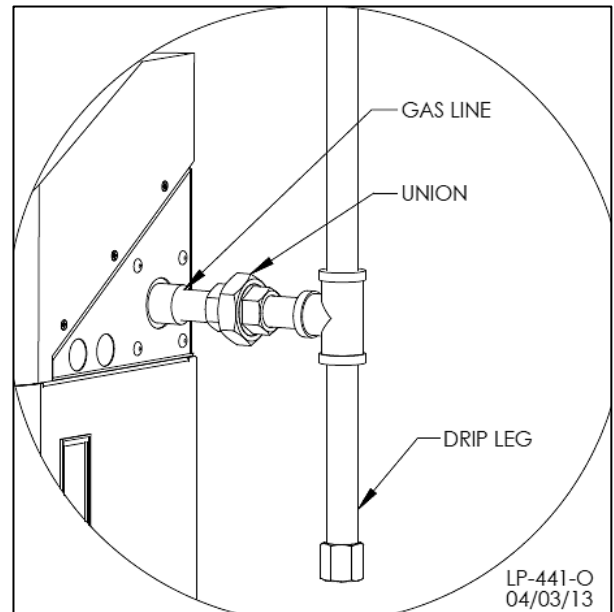

Figure 20 –Gas Connection

⚠ WARNING

UL recognized fuel gas detectors are recommended in all enclosed propane and natural gas applications where there is a potential for an explosive mixture of fuel gas to accumulate. The installation of these detectors should be made in accordance with the detector manufacturer's recommendations, and/or local laws. Failure to install fuel gas detectors in these applications could result in fire, explosion, property damage, severe personal injury, or death.

A. GAS PIPING

Run the gas supply line in accordance with all applicable codes. Locate and install manual shutoff valves in accordance with local and state requirements.

⚠ WARNING

Support gas supply piping with hangers, not by the heater or its accessories. The heater gas valve and blower will not support the weight of the piping. Make sure the gas piping is protected from physical damage and freezing, where required. Failure to follow these instructions could result in gas leakage, and result in fire, explosion, property damage, severe personal injury, or death.

⚠ WARNING

Do not use Teflon tape on gas line pipe thread. Use a pipe compound rated for use with natural and propane gases. Apply sparingly on male pipe ends, leaving the two end threads bare. Failure to follow these instructions could result in gas leakage, and result in fire, explosion, property damage, severe personal injury, or death.

B. GAS TABLE

Refer to the table below to size the supply piping to minimize pressure drop between meter or regulator and unit.

Maximum capacity of pipe in cubic feet of gas per hour for gas pressures of .5 psi or less and a pressure drop of .3 inch water column.

Nominal Iron Pipe Size (In.)	Internal Dia. (In.)	Length of Pipe (Feet)														BTU's Per Hour x 1,000	
		10	20	30	40	50	60	70	80	90	100	125	150	175	200		
½																	
¾	.824	278	190	152	130	115	105	96	90	84	79	72	64	59	55		
1	1.049	520	350	285	245	215	195	180	170	160	150	130	120	110	100		
1 ¼	1.380	1,050	730	590	500	440	400	370	350	320	305	275	250	225	210		

Table 9 – Source – ANSI Z223.1

It is recommended that a soapy solution be used to detect leaks. Bubbles will appear on the pipe to indicate a leak is present. The gas piping must be sized for proper flow and length of pipe to avoid excessive pressure drop. Both the gas meter and the gas regulator must be properly sized for the total gas load. If you experience a pressure drop greater than 1" WC, the meter, regulator or gas line is undersized or in need of service. You can attach a manometer to the incoming gas drip leg by removing the cap. The gas pressure must remain between 3.5" WC and 14" WC during stand-by (static) mode and while in operating (dynamic) mode at full output.

If an in-line regulator is used, it must be a minimum of 10 feet from the heater. It is very important that the gas line is properly purged by the gas supplier or utility. Failure to properly purge the lines or improper line sizing will result in ignition failure. This problem is especially noticeable in NEW LP installations and also in empty tank situations. This can also occur when a utility company shuts off service to an area to provide maintenance to their lines. The gas valve must not be replaced with a conventional gas valve under any circumstances. As an additional safety feature, the gas valve in this water heater has a flanged connection to the swirl plate and blower.

C. GAS VALVE

⚠ WARNING	
Breathing Hazard - Carbon Monoxide Gas	
	<ul style="list-style-type: none"> • Do not operate heater if flood damaged. • Install vent system in accordance with local codes and manufacturers installation instructions. • Do not obstruct heater air intake or exhaust. Support all vent piping per manufacturers installation instructions. • Do not place chemical vapor emitting products near unit. • According to NFPA 720, carbon monoxide detectors should be installed outside each sleeping area. • Never operate the heater unless it is vented to the outdoors. • Analyze the entire vent system to make sure that condensate will not become trapped in a section of vent pipe and therefore reduce the open cross sectional area of the vent.
<p>Breathing carbon monoxide can cause brain damage or death. Always read and understand instruction manual.</p>	
<p>LP-304 4/28/09</p>	

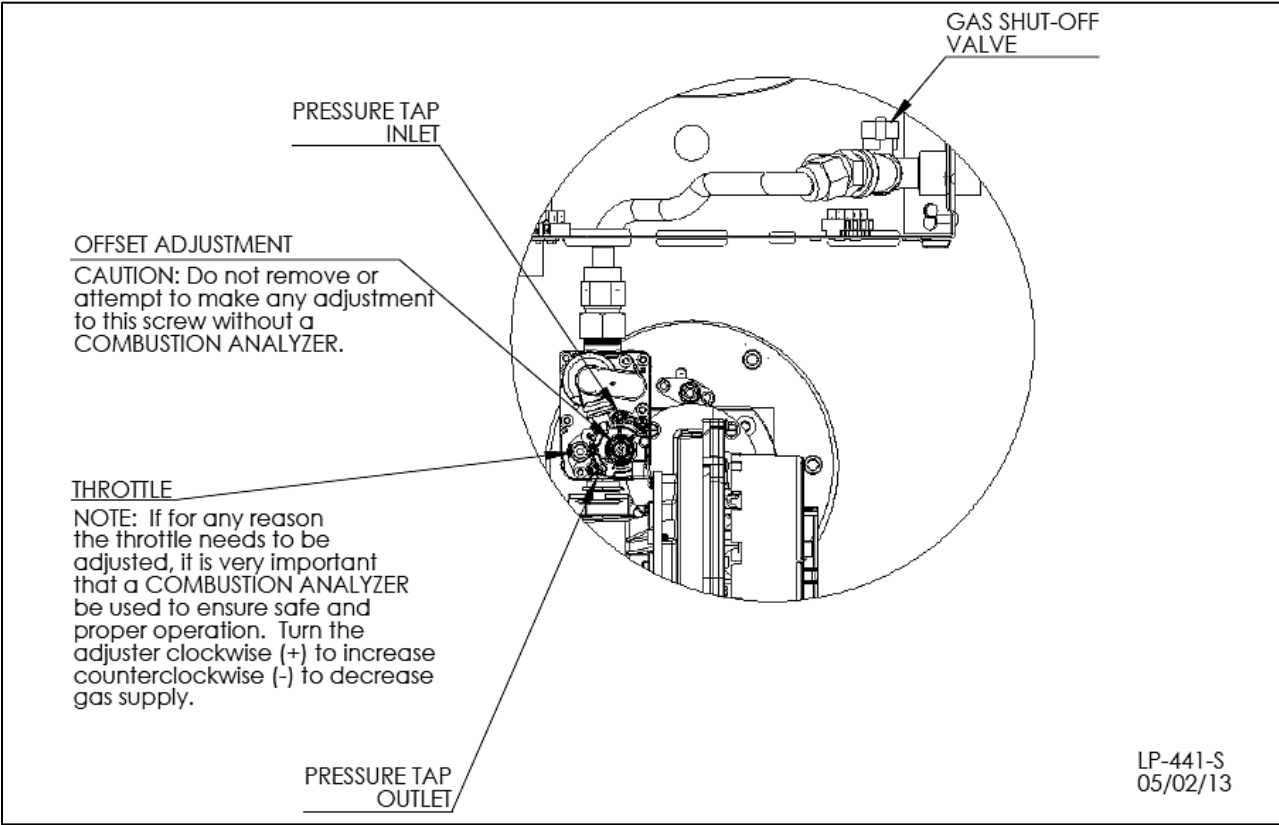

Figure 21 – Gas Valve LP-441-S

⚠ WARNING
<p>Strain on the gas valve and fittings may result in vibration, premature component failure and gas leakage, and result in fire, explosion, property damage, severe personal injury, or death.</p>

⚠ WARNING
<p>Adjustments to the throttle screw or offset may only be made by a qualified gas technician using a calibrated combustion analyzer capable of measuring CO₂ and CO. Failure to follow this instruction could result in fire, explosion, property damage, severe personal injury, or death.</p>

PART 8 – CONTROLS

A. CONTROL AND DISPLAY OVERVIEW

Detailed Description of Button Functions

1. Setting Adjust Down
2. Setting Adjust Up
3. Decreases the User Setpoint
4. Increases the User Setpoint
5. ECO Mode
6. RESET
7. OFF / Mode Enable

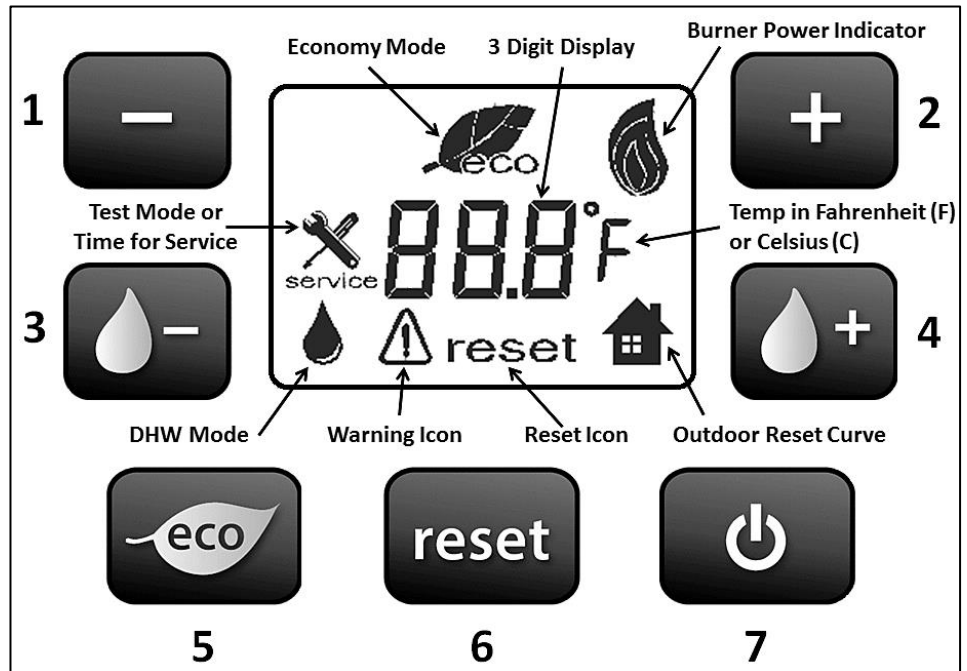

Figure 22 – Control Detail

Detailed Description of Control Functions

MODES OF OPERATION			
MODE	SCREENSHOT	DESCRIPTION	RANGE (DEFAULT)
Off Mode		The water heater will ignore heat demands while in Off Mode. To put the water heater into Off Mode, press .	Off / On (Off)
Stand-By Mode		In Stand-By Mode, the fan is off, the gas valve is closed, and the water inlet shut-off valve is opened. The water heater goes into Stand-By Mode when it is powered but not firing.	On Winter / On Summer / Off (Off)
User Setpoint		The User Setpoint is used to set the temperature for the water heater. Press either or once to change the User Setpoint. The normal operation screen will clear and be replaced by a flashing number. This is the User Setpoint. Press to decrease or to increase the setpoint in increments of two degrees. After choosing the setpoint, wait five seconds. The screen will return to normal operation and the setpoint will be stored.	70 – 160 (120)
Outdoor Reset Curve		Enabling Outdoor Reset Curve allows the user to set additional parameters to increase water heater efficiency. An Outdoor Sensor is required to set Outdoor Reset Curve. See Advanced Control Functions to set the Outdoor Reset Curve.	0 = Enabled, 1 = Disabled (0)















ECO Mode		Putting the water heater into ECO Mode reduces maximum firing rate to 80% of the rated maximum firing rate. This increases water heater efficiency in times of low hot water demand. Press  to put the water heater into ECO mode. Press again to return to normal operation.	ECO On / Off (Off)
Test Mode		Test Mode allows the installer to test water heater operation by running the fan at different speeds. To enter Test Mode, press  and  together for 5 seconds. Push  to decrease or push  to increase fan speed by 50 RPM increments. Push  to operate at maximum fan speed. Push  to operate at minimum fan speed. Test Mode will exit automatically after 15 minutes. Press  to leave Test Mode manually.	Test Mode On / Off (Off)
Lockout Fault Codes		Lockout codes refer to a temporary condition that must be cleared to resume operation. If code persists, the heater should be serviced by a qualified service technician.	Press  to clear the code. Observe operation to ensure code does not reoccur.
Blocking Error Codes		Blocking codes temporarily stop water heater operation until the error condition clears. Once the condition clears, the error will disappear and the water heater will resume operation. The error will also be written into the water heater's history data.	Water heater operation resumes when conditions return to normal.
Installer Mode		The Installer Mode allows installers to view history hidden from the user. See Advanced Control Functions for information on how to enter	Installer Mode On / Off (Off)
<p>NOTE:  is a high temperature warning, and appears on the display if setpoint or actual water temperature is above 125°F. Water temperature over 125°F can instantly cause severe burns or death from scalds. Children, disabled, and elderly are at the highest risk of being scalded.</p>			

Table 10 – Water Heater Modes of Operation

B. BASIC CONTROL FUNCTIONS

There are a number of parameters accessible from the water heater main screen. These parameters are especially useful for the main user of the water heater.

NOTE: These parameters ARE NOT ACCESSIBLE when the control is in a blocking or lockout state.

1. TURNING WATER HEATER ON / OFF

Press  to turn the water heater on / off.

2. RESETTING THE WATER HEATER

Press  to clear a fault code lockout and resume water heater operation.

3. PUTTING THE WATER HEATER IN ECO MODE

Press  to put the water heater into ECO Mode. Press  to resume normal operation.

4. CHANGING USER SETPOINT

Press either or once to change the User Setpoint. The normal operation screen will clear and be replaced by a flashing number. This is the User Setpoint.

Press to decrease or to increase the setpoint. The default setpoint is 120°F. The setpoint range is 70 – 160°F. After choosing the setpoint, wait five seconds. The screen will return to normal operation and the setpoint will be stored.

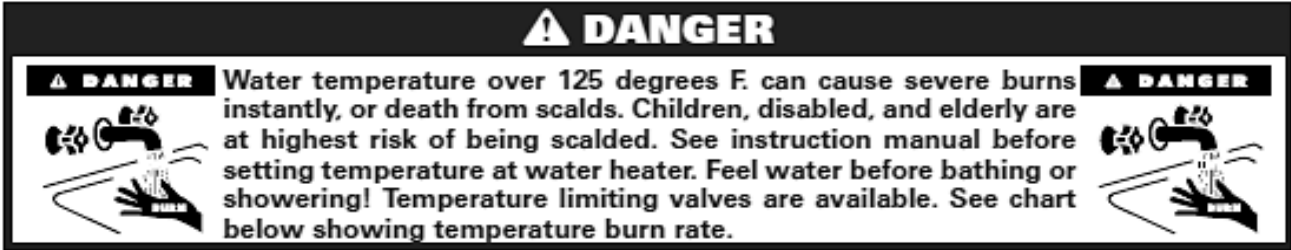

C. ADVANCED CONTROL FUNCTIONS

The water heater control Installer Mode includes numerous parameters for system customization. These parameters should only be accessed and changed by a qualified service technician.

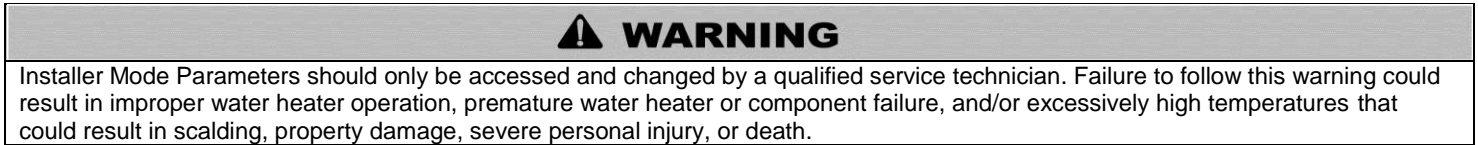

NOTE: Water heater failures caused by improper Installer Mode Parameter sets WILL VOID product warranty.

To enter Installer Mode, press and hold for five seconds. When the following screen appears, Installer Mode is active.



1. UPPER LEVEL INSTALLER MODE MENU NAVIGATION

See Figure 24 for information on how to navigate the Installer Menu Upper Level.

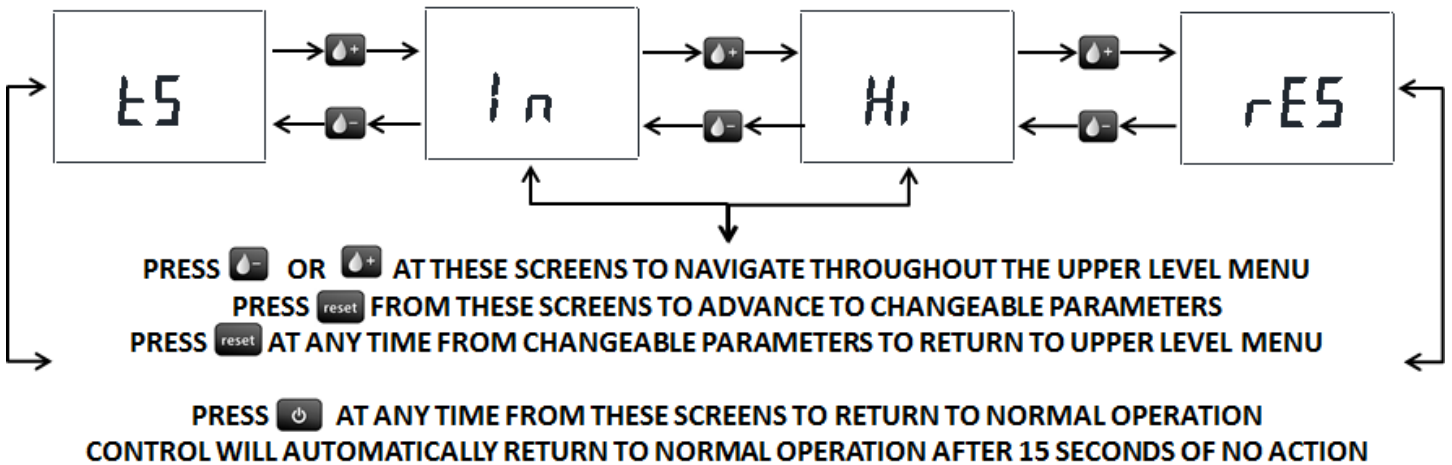

Figure 23 – Upper Level Navigation

2. TECHNICAL SERVICE AND NAVIGATION

The Technical Service Menu () is the initial menu to appear when entering Installer Mode. Technical Service Parameters allow the installer to fully customize water heater settings to the system. The control is ready to access the Technical Service Parameter Menu when the following screen appears on the display.



To enter Installer Mode, press and hold **reset** for five seconds. When the (55) screen appears, Installer Mode is active. Press **reset** at this screen to access the Technical Service Parameters codes (P00, P01, etc.).

To change parameter value, press **-** or **+** once. The value will appear. Press **-** to decrease or **+** to increase the value. Press **reset** at this screen to accept the changed value and return to the Technical Service Parameters.

Press **+** to advance through the parameters. Press **-** to return to the previous parameter.

Press **reset** at any Technical Service Parameter code screens to return to the upper level menu.

Table 11 details the Technical Service Parameters in sequential order.

CODE	SHORT DESCRIPTION	LONG DESCRIPTION	RANGE (DEFAULT)
P00	User Setpoint (°F)	Minimum Tank Temperature	70 – 160 (120)
P01	Temperature Differential (°C/°F)	Difference Between Actual Tank Temperature and User Setpoint that will Initiate Demand	4 – 20 (8)
P02	Maximum Power Percentage (%)	Maximum Combustion System Power	50 – 100 (80)
P03	Temperature Unit Displayed	Fahrenheit or Celsius	0 = °C / 1 = °F (1)
P04	ECO Mode	Economy Mode	0 = Off / 1 = On (0)
P05	Outdoor Reset Curve	Turns on the Outdoor Reset Curve NOTE: The following parameters are applicable only if the Outdoor Reset Curve is turned on.	0 = Off / 1 = On (0)
P06	Minimum Outdoor Temperature (°C/°F)	Minimum outdoor design conditions for reset curve	10 – 70 (10)
P07	Maximum Outdoor Temperature (°C/°F)	Maximum outdoor design conditions for reset curve	10 – 70 (68)
P08	Minimum Storage Temperature (°C/°F)	Minimum tank temperature for reset curve	70 – 160 (120)
P09	Maximum Storage Temperature (°C/°F)	Maximum tank temperature for reset curve	70 – 160 (140)
P10	Warm Weather Shutdown Temperature (°C/°F)	Outdoor temperatures greater than this value return the tank target temperature to the User Setpoint	50 – 100 (68)

Table 11 – Technical Service Parameters - NOTE: Temperature Readings Depend on Temperature Unit Selection

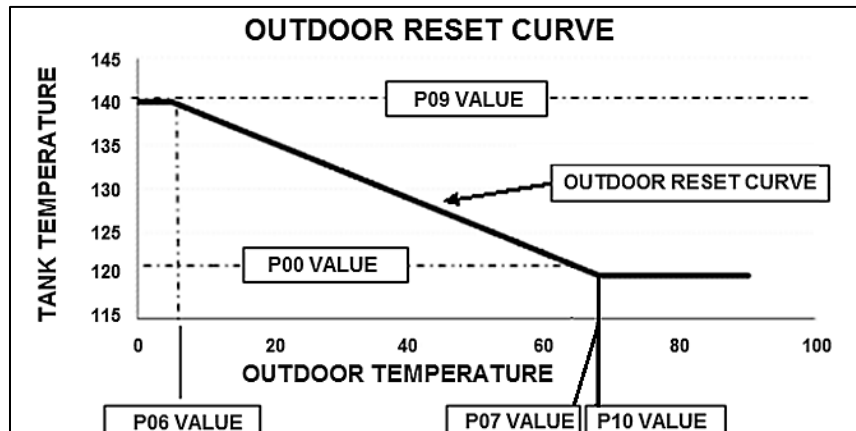













Figure 24 – Outdoor Reset Curve

D. OUTDOOR RESET

This unit is supplied with outdoor reset wire connection terminals. **When an outdoor sensor is connected, operation of the unit immediately changes.** Refer to the following steps to properly set up the unit with an outdoor sensor.



⚠ DANGER

An ASSE 1017 thermostatic mixing valve **MUST** be installed when using outdoor reset. Failure to do so could result in substantial property damage, serious injury, or death.

1. Connect the outdoor sensor to the terminals marked “outdoor”.
2. Press  at this screen to access the Technical Service Parameters codes (P00, P01, etc.).
3. Press  to advance through the parameters. Press  to return to the previous parameter.
4. Go to P06
5. Enter desired MIN Outdoor Temp value
6. Press  to advance to the next parameter.
7. To change parameter value, press  or  once. The value will appear. Press  to decrease or  to increase the value.
8. Enter desired MAX Outdoor Temp value
9. Press  to advance to the next parameter.
10. Enter desired MIN Storage Temp value
11. Press  to advance to the next parameter.
12. Enter desired MAX Storage Temp value
13. Press  at this screen to accept the changed value and return to the Installer Parameters.
14. Press  at any Installer Parameter code screens to return to the upper level menu.



1. INQUIRY MODE AND NAVIGATION



Inquiry Mode (*i n*) allows the installer to access water heater operating specifics, including temperature sensor and flame sensor readings. These readings aid the installer in troubleshooting the water heater.

To enter Installer Mode, press and hold  for five seconds. When the (*E5*) screen appears, Installer Mode is active. Press  once to find Inquiry Mode. The control is ready to access the Inquiry Mode when the following screen appears on the display.



Press  at this screen to access the Inquiry Mode codes (i00, i01, etc.).

To view code value, press  or  once. The value will appear. Press  at this screen to return to the code screen.

Press  to advance through the codes. Press  to return to the previous code.

Press  at any Inquiry Mode code screens to return to the upper level menu.



Table 12 details the Inquiry Mode codes in sequential order.

CODE	DESCRIPTION	RANGE
i00	UPPER (HL NTC1) SENSOR TEMPERATURE (°C/°F)	Between 32 and 257°F
i01	(--*)	--*
i02	Ventilation Sensor Temperature (°C/°F)	Between 32 and 257°F
i03	Outdoor Sensor Temperature (°C/°F)	Between 32 and 257°F
i04	Actual Flame Current (uA x 10)	Between 00 and 99
i05	Firmware Version	Custom Version C_x.xx
i06	Actual Fan Speed	

Table 12 – History Mode Codes – NOTE: Temperature Readings Depend on Temperature Unit Selection – *NOTE: -- Means option is not available or in use.



2. HISTORY MODE AND NAVIGATION



History Mode (*H_i*) aids the installer in troubleshooting by allowing access to the last eight (8) error or fault codes that have occurred.

To enter Installer Mode, press and hold  for five seconds. When the (E5) screen appears, Installer Mode is active. Press  twice to find History Mode. The control is ready to access the History Mode when the following screen appears on the display.



Press  at this screen to access the History Mode codes (H01, H02, etc.).

Press  to advance through the codes. Press  to return to the previous code.

To view code value, press  or  once. The value will appear. Press  at this screen to return to the code screen.

Press  at any History Mode code screens to return to the upper level menu.



Table 13 details the History Mode codes in sequential order.

CODE	DESCRIPTION
H01	Most Recent Error or Fault Code
H02	Second Most Recent Error or Fault Code
H03	Third Most Recent Error or Fault Code
H04	Fourth Most Recent Error or Fault Code
H05	Fifth Most Recent Error or Fault Code
H06	Sixth Most Recent Error or Fault Code
H07	Seventh Most Recent Error or Fault Code
H08	Eighth Most Recent Error or Fault Code

Table 13 – History Mode Codes – NOTE: Temperature Readings Depend on Temperature Unit Selection

3. RESET MODE AND NAVIGATION

Reset Mode ($r\text{E5}$) allows the installer to reset and clear water heater history. This is especially helpful after troubleshooting or repairs have concluded.

To enter Installer Mode, press and hold  for five seconds. When the (E5) screen appears, Installer Mode is active. Press  three times to find Reset Mode. The control is ready to access Reset Mode when the following screen appears on the display.



Press and hold  at this screen for five seconds to reset the water heater history.

Press  to return to History Mode. View History Mode to ensure history has been cleared.

Press  at any History Mode code screens to return to the upper level menu.

PART 9 – START-UP PROCEDURE

⚠ WARNING

FOR YOUR OWN SAFETY READ BEFORE OPERATING

1. This water heater does not have pilot. It is equipped with an ignition device which automatically lights the burner. Do not try to light the burner by hand.

2. BEFORE OPERATING: smell all around the water heater area for gas. Be sure to smell next to the floor because some gas is heavier than air and will settle on the floor.

WHAT TO DO IF YOU SMELL GAS

- Do not try to light any water heater.
- Do not touch any electric switch; do not use any phone in your building.
- Immediately call your gas supplier from a neighbor's phone. Follow the gas suppliers' instructions.
- If you cannot reach your gas supplier, call the fire department.
- Turn off gas shutoff valve (located outside of the water heater) so that the handle is crosswise to the gas pipe. If the handle will not turn by hand, don't try to force or repair it, call a qualified service technician. Force or attempted repair may result in a fire or explosion.

4. Do not use this water heater if any part has been under water. Immediately call a qualified service technician to inspect the water heater and to replace any part of the control system and any gas control that has been damaged.

5. The water heater shall be installed so the gas ignition system components are protected from water (dripping, spraying, rain, etc.) during water heater operation and service (circulator replacement, condensate trap, control replacement, etc.)

Failure to follow these instructions could result in property damage, serious personal injury, or death.

A. OPERATING INSTRUCTIONS

If you smell gas, STOP. Follow listed safety instructions above. If you do not smell gas, follow the next steps.

1. Make sure tank is full with cold water and purge all piping. To assure adequate purging, open all hot water faucets.

⚠ WARNING

Ensure the water heater is full of water before firing the burner. Failure to do so will damage the heater. Such damage IS NOT covered by warranty, and could result in property damage, serious personal injury, or death.



2. Turn on all electric power to water heater.

3. Remove the Front Panel WARNING label.

4. Adjust the temperature set point of the heater to the desired level. The factory default setting is 120oF. If changes are necessary, follow "Overall Water Heater and Control Operation" in this section.

5. If the water heater fails to start, refer to the Troubleshooting section in the back of this manual.

B. TEST MODE





Test mode is enabled by pressing  and  together for 5 seconds. In this mode the water heater operates without modulation, and the combustion system initially runs at the maximum fan speed. The SERVICE symbol is displayed on the LCD when Test mode is active.





RESISTANCE TABLE FOR SUPPLY TEMPERATURE SENSOR	
HIGH/LOW TEMP. SENSOR TEMP. (°F)	RESISTANCE (ohms)
32	32550
41	25340
50	19870
59	15700
68	12490
77	10000
86	8059
95	6535
104	5330
113	4372
122	3605
131	2989
140	2490
149	2084
158	1753
167	1481
176	1256
185	1070
194	915
202	786
212	667

Table 14

Test mode can be used to incrementally increase and decrease fan speed to test the combustion system. See Tables 15 and 16 for Combustion Settings and Fan Speeds.

1. Use the  and  push buttons to change the fan speed (steps of 50 rpm) between the range *maximum fan speed* and *minimum fan speed*
2. Use the  to go directly to the *maximum fan speed*
3. Use the  to go directly to the *minimum fan speed*

Range between *minimum fan speed* and *maximum fan speed* is taken as absolute *power* value (0 - 100%).

During Test mode, the LCD flame symbols are enabled as follows:
 Flame ON and *power* < 30% then one third of the flame symbol will display 
 Flame ON and *power* > 30% or < 75% then two thirds of the flame symbol will display 
 Flame ON and *power* > 75% then the full flame symbol will display 

Burner ON and OFF conditions are:
 Burner ON: UPPER temperature < 185°C
 Burner OFF: UPPER temperature ≥ 194°C

The function is enabled for a maximum of 15 minutes.

Test mode can be disabled by pressing  button.

⚠ WARNING

Breathing Hazard - Carbon Monoxide Gas



- Do not operate heater if flood damaged.
- Install vent system in accordance with local codes and manufacturers installation instructions.
- Do not obstruct heater air intake or exhaust. Support all vent piping per manufacturers installation instructions.
- Do not place chemical vapor emitting products near unit.
- According to NFPA 720, carbon monoxide detectors should be installed outside each sleeping area.
- Never operate the heater unless it is vented to the outdoors.
- Analyze the entire vent system to make sure that condensate will not become trapped in a section of vent pipe and therefore reduce the open cross sectional area of the vent.

Breathing carbon monoxide can cause brain damage or death. Always read and understand instruction manual.

LP-304 4/28/09

COMBUSTION SETTINGS ON ALL MODELS						
Fan Speed	Natural Gas			Propane LP		
	Low	Ignition	High	Low	Ignition	High
Carbon Monoxide PPM	1 – 10	2 - 15	2 – 20	1 – 10	2 - 15	2 – 20
Carbon Dioxide (CO₂)	8 - 10%	8 – 10%	8 - 10%	8 ½ - 10 ½%	8 ½ - 10 ½%	9 - 11%

Table 15 – Combustion Settings on All Models

FAN SPEEDS			
BTU (FUEL)	IGNITION	MIN	MAX
76000 (NATURAL)	5000	2150	6300
76000 (LP)	3800	2100	6300

Table 16 – Fan Speeds

C. MAINTENANCE

The control system requires no periodic maintenance under normal conditions. However, in unusually dirty or dusty conditions, periodic vacuuming of the cover to maintain visibility of the display and indicators is recommended. In dirty environments, such as construction sites, care must be taken to keep the water heater burner cover in place and drywall or saw dust away from water heater.

⚠ CAUTION

In unusually dirty or dusty conditions, care must be taken to keep water heater burner door in place. **Failure to do so VOIDS WARRANTY!**

⚠ WARNING

Allowing the heater to operate with a dirty combustion chamber will hurt operation. Failure to clean the heat exchanger as needed by the installation location could result in heater failure, property damage, personal injury, or death. Such product failures ARE NOT covered under warranty.

PART 10 – SHUTDOWN

A. SHUTDOWN PROCEDURE

If the burner is not operating, lower the set point value to 70°F and wait for the burner to shut off. Continue to wait for the combustion blower to stop, so all latent combustion gases are purged from the system. This should take a maximum of 300 seconds (5 minutes).

B. VACATION PROCEDURE

If there is danger of freezing, change the set point to 70°F. DO NOT turn off electrical power. If there is no danger of freezing, follow “Shutdown Procedure”.

C. FAILURE TO OPERATE

Should the burner fail to light, the control will perform two more ignition trials prior to entering a lockout state. Note that each subsequent ignition trial will not occur immediately. After a failed ignition trial, the blower must run for approximately 10 seconds to purge the system. Therefore, a time period of approximately 40 to 90 seconds will expire between each ignition trial.

If the burner lights during any one of these three ignition trails, normal operation will resume. If the burner lights, but goes off in about 4 seconds, check the polarity of the wiring. See electrical connection section.

If the burner does not light after the third ignition trial, the control will enter a lockout state. This lockout state indicates that a problem exists with the water heater, the controls, or the gas supply. Under such circumstances, a qualified service technician should be

contacted immediately to properly service the water heater and correct the problem. If a technician is not available, pressing the  button will remove the lockout state so additional trials for ignition can be performed.

D. IMPORTANT NOTICE

NOTICE

It is extremely important that whenever work is performed on the plumbing system that either:

- The water heater is powered off, or,
- The water heater is valved off and isolated from the plumbing system.

Failure to take these measures could result in a dry-firing condition.

⚠ WARNING

The water heater must be full of water and the system fully purged BEFORE powering the water heater. Performing any work in the plumbing system without either powering off the water heater or isolating the water heater through the use of shut-off valves could result in a condition referred to as “dry-firing”. Dry-firing the water heater will damage the heat exchanger, and could result in property damage, serious personal injury, or death. Such damages ARE NOT covered by water heater warranty.

PART 11 – TROUBLESHOOTING

A. ERROR CODE

An error code may occur during installation of the heater. This condition may lead to a lock out condition of the controller, which will need to be manually reset by pressing the  button.

B. HEATER ERROR

1. When an error condition occurs the controller will display an error code on the display module.
2. These error codes and several suggested corrective actions are included in Table 17.
3. In the case of **E07**, and **E13**, this error, if uncorrected, will go into a fault condition as described in Paragraph C.

C. LOCKOUT

1. When a fault condition occurs the controller display a fault code (Example: **F00**) on the display module.
2. Note the fault code and refer to Table 18 for an explanation of the fault code along with several suggestions for corrective actions.

3. Press the  key to clear the fault and resume operation. Be sure to observe the operation of the unit to prevent a recurrence of the fault. NOTE: You are allowed up to 5 “resets” to clear a Fault or Error code. After that, the controller will enter an **E13** Lockout state.

⚠ WARNING

When servicing or replacing any components of this water heater be certain that:

- The gas is off.
- All electrical power is disconnected.

⚠ DANGER

When servicing or replacing components that are in direct contact with heater water, be certain that:

- There is no pressure in the heater. Pull the release on the relief valve to relieve pressure in the heater.
- Heater water is not hot.
- The electrical power is off.

⚠ WARNING

DO NOT USE THIS APPLIANCE IF ANY PART HAS BEEN SUBMERGED IN WATER. Immediately call a qualified service technician. The appliance **MUST BE** replaced if it has been submerged. Attempting to operate an appliance that has been submerged could create numerous harmful conditions, such as a potential gas leakage causing a fire and/or explosion, or the release of mold, bacteria, or other harmful particulates into the air. Operating a previously submerged appliance could result in property damage, severe personal injury, or death.

NOTE: Appliance damage due to flood or submersion is considered an Act of God, and IS NOT covered under product warranty.

⚠ CAUTION

The water heater has wire function labels on all internal wiring. Observe the position of each wire before removing it. Wiring errors may cause improper and dangerous operation. Verify proper operation after servicing.

CONTROL BOARD BLOCKING ERRORS

CODE	SHORT DESCRIPTION	LONG DESCRIPTION	CORRECTIVE ACTION
E07	Flue Temperature Too High	The Flue temperature has met / surpassed the maximum limit. This is first an E07 blocking error code.	<ol style="list-style-type: none"> 1. Is the tank full of water? This error code will appear if the tank is dry-fired. 2. Measure actual Flue temperature. 3. Use an ohmmeter to check resistance on flue temperature sensor. 4. Replace sensor if it does not pass the resistance test. 5. If Flue temperature does not return to normal within 15 minutes, E07 shall become an F07 fault code. 6. Error will clear automatically if Flue temperature returns to normal within 15 minutes.
E13	Remote Reset Volatile Lockout	FIVE RESET attempts counter has been exhausted	Service and repair unit per displayed error code. Turn the main power supply to the unit off and back on to clear out the error code.
E34	Low Main Power Supply	The main power supply is too low (below 75 VAC) to properly power the water heater.	<ol style="list-style-type: none"> 1. When main power is brought back to a normal state (over 75 VAC), water heater will resume normal operation. 2. Measure AC Mains.
E39	Outdoor Temperature Sensor Error (When Enabled)	The Outdoor Temperature Sensor is out of normal operating range, meaning the sensor is either open or shorted.	<ol style="list-style-type: none"> 1. Check the Outdoor Temperature Sensor. Ensure it is properly wired and connected, and that there are no breaks, cuts, or other visible issues with the sensor wire. 2. Use an ohmmeter to check resistance on the outdoor temperature sensor. 3. Replace Outdoor Temperature Sensor if it fails the resistance test.
E53	Flue Temperature Sensor Error	The Flue Temperature Sensor is out of normal operating range, meaning the sensor is either open or shorted.	<ol style="list-style-type: none"> 1. Check the Flue Temperature Sensor. Ensure it is properly wired to the control, and that there are no breaks, cuts, or other visible issues with the sensor wire. 2. Use an ohmmeter to check resistance on flue temperature sensor. 3. Replace Flue Temperature Sensor if it does not pass the resistance test.
E64	Blocked Flue	The control detects a blocked Flue condition.	<ol style="list-style-type: none"> 1. Check the Flue termination. Ensure there are no blockages or obstructions in the Flue. 2. Check APS switch. Ensure it is properly wired to the control, and that there are no breaks, cuts, or other visible issues with the wiring. 3. Replace APS switch.

Table 17 – Blocking Error Codes

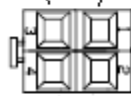
CONTROL BOARD LOCKOUT FAULTS			
CODE	SHORT DESCRIPTION	LONG DESCRIPTION	CORRECTIVE ACTION
F01	Ignition Lockout Indication	The control senses no flame after three ignition attempts.	<ol style="list-style-type: none"> 1. Is the gas turned on to the water heater? 2. Manually reset the water heater. 3. Observe water heater operation. If fault code occurs again 4. Check for stable gas pressure. 5. Check Ignitor cable connections. 6. Check Ignitor cable gound. 7. Replace cable. 8. Check spark gap between spark electrode and burner. 9. Replace ignitor.
F02	False Flame Indication	The control senses a flame signal when there is no heat demand.	<ol style="list-style-type: none"> 1. Visually check for flame through sight glass. 2. Manually reset the water heater. 3. Observe water heater operation. If fault code occurs again 4. Check Ignitor cable connections 5. Check Ignitor cable gound 6. Replace cable 7. Replace ignitor
F03	High Limit Temperature Protection	The control shuts down the water heater after it has met / surpassed the high temperature limit.	<ol style="list-style-type: none"> 1. Manually reset the water heater. 2. Observe water heater operation. If fault code occurs again 3. Check the Dual Temperature Sensor. Ensure it is properly wired to the control, and that there are no breaks, cuts, or other visible issues with the sensor wire. 4. Use an ohmmeter to check resistance on first Sensor A, then Sensor B of the Dual Temperature Sensor. 5. Replace Dual Temperature Sensor if either Sensor A or Sensor B fails the resistance test. <p style="text-align: center;">SENSOR "A"</p>  <p style="text-align: center;">SENSOR "B"</p>
F05	Incorrect Fan Speed	The control detects incorrect fan speed.	<ol style="list-style-type: none"> 1. Manually reset the water heater. 2. Observe water heater operation. If fault code occurs again 3. Check condition of wiring 4. Check Fan PWM connections at control board and fan 5. Replace fan
F07	Vent Temperature Too High	The vent temperature has met / surpassed the maximum limit. This is first an E07 blocking error code. If vent temperature has not returned to normal levels within 15 minutes, this becomes an F07 lockout fault code.	<ol style="list-style-type: none"> 1. Manually reset the water heater. 2. Observe water heater operation. If fault code occurs again 3. Replace sensor 4. Measure actual vent temperature.
F08	Flame Circuit Failure	The control detects an incorrect flame level.	<ol style="list-style-type: none"> 1. Manually reset the water heater. 2. Observe water heater operation. If fault code occurs again 3. Check Ignitor cable connections 4. Check Ignitor cable gound 5. Replace cable 6. Check spark gap between spark electrode and burner. 7. Replace ignitor
F09	Valve Feedback Error	The gas valve does not respond to controller demands.	<ol style="list-style-type: none"> 1. Manually reset the water heater. 2. Observe water heater operation. If fault code occurs again, reset the water heater and: 3. When water heater attempts to fire, check voltage at the gas valve connector. If there is voltage, but no gas pressure on the outlet side of the valve, the valve is stuck closed. Replace the gas valve. 4. If there is no voltage at the ignition phase, replace the control board.
F12	EEPROM Integrity Lockout	The EEPROM check fails. EEPROM data is corrupted.	<ol style="list-style-type: none"> 1. Manually reset the water heater. 2. Observe water heater operation. 3. If fault code occurs again, replace controller.

<p>F14</p>	<p>Tank Sensor Data Not Consistent</p>	<p>The data received from the tank sensors exceeds the difference allowed by the control.</p>	<ol style="list-style-type: none"> 1. Manually reset the water heater. 2. Observe water heater operation. If fault code occurs again 3. Check the Dual Temperature Sensor. Ensure it is properly wired to the control, and that there are no breaks, cuts, or other visible issues with the sensor wire. 4. Use an ohmmeter to check resistance on first Sensor A, then Sensor B of the Dual Temperature Sensor. 5. Replace Dual Temperature Sensor if either Sensor A or Sensor B fails the resistance test <p style="text-align: center;">SENSOR "A"</p>  <p style="text-align: center;">SENSOR "B"</p>
<p>F21</p>	<p>ADC Failure</p>	<p>The ADC test has detected a major fault in the electronic components.</p>	<ol style="list-style-type: none"> 1. Manually reset the water heater. 2. Observe water heater operation. 3. If fault code occurs again, replace the controller.
<p>F31</p>	<p>Dual Temperature Sensor B Error</p>	<p>Dual Temperature Sensor B is out of normal operating range, meaning the sensor is either open or shorted.</p>	<ol style="list-style-type: none"> 1. Manually reset the water heater. 2. Observe water heater operation. 3. Check the Dual Temperature Sensor. Ensure it is properly wired to the control, and that there are no breaks, cuts, or other visible issues with the sensor wire. 4. Use an ohmmeter to check resistance on first Sensor B of the Dual Temperature Sensor. Values should be close to those given in Table 14 5. Replace Dual Temperature Sensor if either Sensor B fails the resistance test. <p style="text-align: center;">SENSOR "A"</p>  <p style="text-align: center;">SENSOR "B"</p>
<p>F35</p>	<p>Dual Temperature Sensor A Error</p>	<p>Dual Temperature Sensor A is out of normal operating range, meaning the sensor is either open or shorted.</p>	<ol style="list-style-type: none"> 1. Manually reset the water heater. 2. Observe water heater operation. 3. Check the Dual Temperature Sensor. Ensure it is properly wired to the control, and that there are no breaks, cuts, or other visible issues with the sensor wire. 4. Use an ohmmeter to check resistance on first Sensor A of the Dual Temperature Sensor. Values should be close to those given in Table 14 5. Replace Dual Temperature Sensor if either Sensor A fails the resistance test. <p style="text-align: center;">SENSOR "A"</p>  <p style="text-align: center;">SENSOR "B"</p>
<p>F82</p>	<p>Unstable Flame Lockout</p>	<p>The control detects an unstable flame.</p>	<ol style="list-style-type: none"> 1. Manually reset the water heater. 2. Observe water heater operation. 3. If fault code occurs again check for stable gas pressure. 4. check Ignitor cable connections 5. Check Ignitor cable ground 6. Replace cable 7. Replace ignitor

Table 18 – Lockout Fault Codes – NOTE: If you replace a part to remedy a fault, it is recommended that you cycle the unit at least three or four times to assure the fault has been resolved.

WHL-001-Q
06/19/14

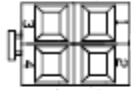
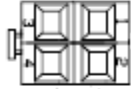
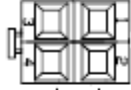
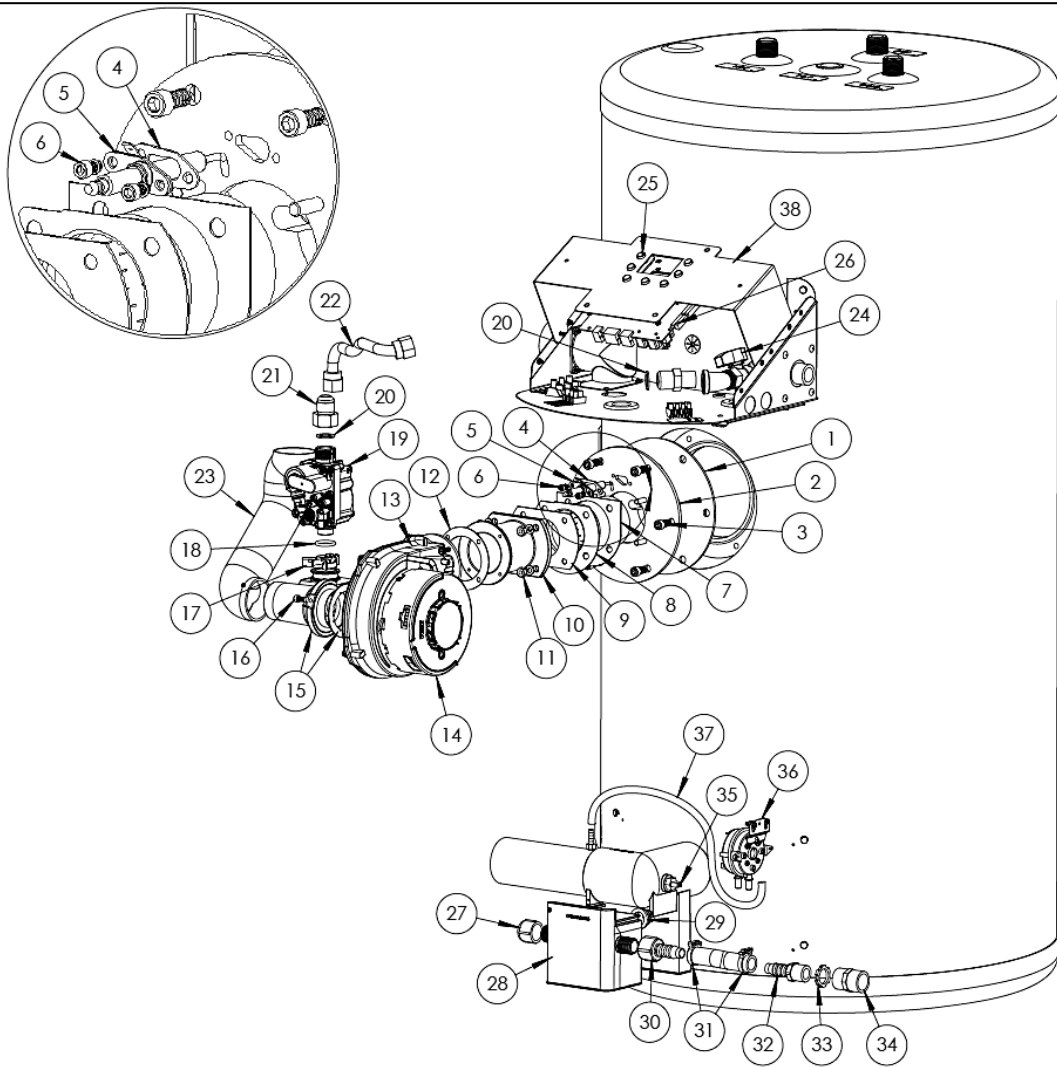

ITEM #	DESCRIPTION	REPLACEMENT PART #
1	GASKET - BURNER MOUNTING PLATE	7700P-017
2	BURNER MOUNTING PLATE (w/GASKET)	7700P-016
3	SCREWS - 5/16-18 - BURNER MOUNTING PLATE	7700P-101
4	GASKET - IGNITOR	7700P-071
5	ELECTRODE - SPARK (w/GASKET)	7100P-124
6	SCREWS/WASHERS 10-32 - ELECTRODE (2)	7100P-097
7	GASKET - BURNER FLANGE	7100P-152
8	BURNER (w/GASKET)	7700P-104
9	GASKET - BLOWER OUTLET	7000P-361
	GASKET - BLOWER OUTLET (LP ONLY)	7700P-107
10	AIR INLET CHANNEL	7700P-003
11	NUTS/WASHER - 1/4-20	7100P-268
12	GASKET - AIR INLET CHANNEL/BLOWER	7500P-075
	GASKET - AIR INLET CHANNEL/BLOWER (LP ONLY)	7700P-106
13	SCREW - 10-32 - COMBUSTION BLOWER	7700P-094
14	COMBUSTION BLOWER	7700P-102
15	VENTURI (w/GASKET)	7700P-032
16	SCREW - M5 X 8MM - VENTURI	7700P-095
17	CLIP - VENTURI	7700P-034
18	O-RING - VENTURI	7700P-035
19	GAS VALVE	7700P-036

ITEM#	DESCRIPTION	REPLACEMENT PART #
20	WASHER - FEMALE ADAPTER	7450P-115
21	FITTING - FEMALE ADAPTER	7700P-072
22	GAS LINE - FLEXIBLE 1/2"	7100P-140
23	AIR INLET	7500P-189
24	GAS SHUT-OFF VALVE	7250P-140
25	KEYPAD	7700P-039
26	CONTROL BOARD - NATURAL GAS	7700P-037
	CONTROL BOARD - LP GAS	7700P-004
27	CAP - 1/2" NPT	7700P-078
28	CONDENSATE NEUTRALIZER CARTRIDGE	7700P-026
29	WASHER - NEUTRALIZER	7700P-031
30	ADAPTER - 1/2" NPT FEM X BARB	7700P-076
31	CONDENSATE HOSE (w/CLAMPS)	7700P-068
32	FITTING - 1/2" NPT MALE X BARB	7100P-044
33	LOCKNUT - 1/2"	7700P-002
34	ADAPTER - 1/2 X 1/2	7700P-077
35	COMBINATION TEMPERATURE SENSOR	7450P-026
36	PRESSURE SWITCH	7700P-038
37	HOSE - PRESSURE SWITCH	7000P-805
38	CONTROL BOARD MOUNTING PANEL	7700P-044
	LOW VOLTAGE WIRE HARNESS (NOT SHOWN)	7700P-085
	120V WIRE HARNESS (NOT SHOWN)	7700P-086

Figure 25 – Replacement Parts

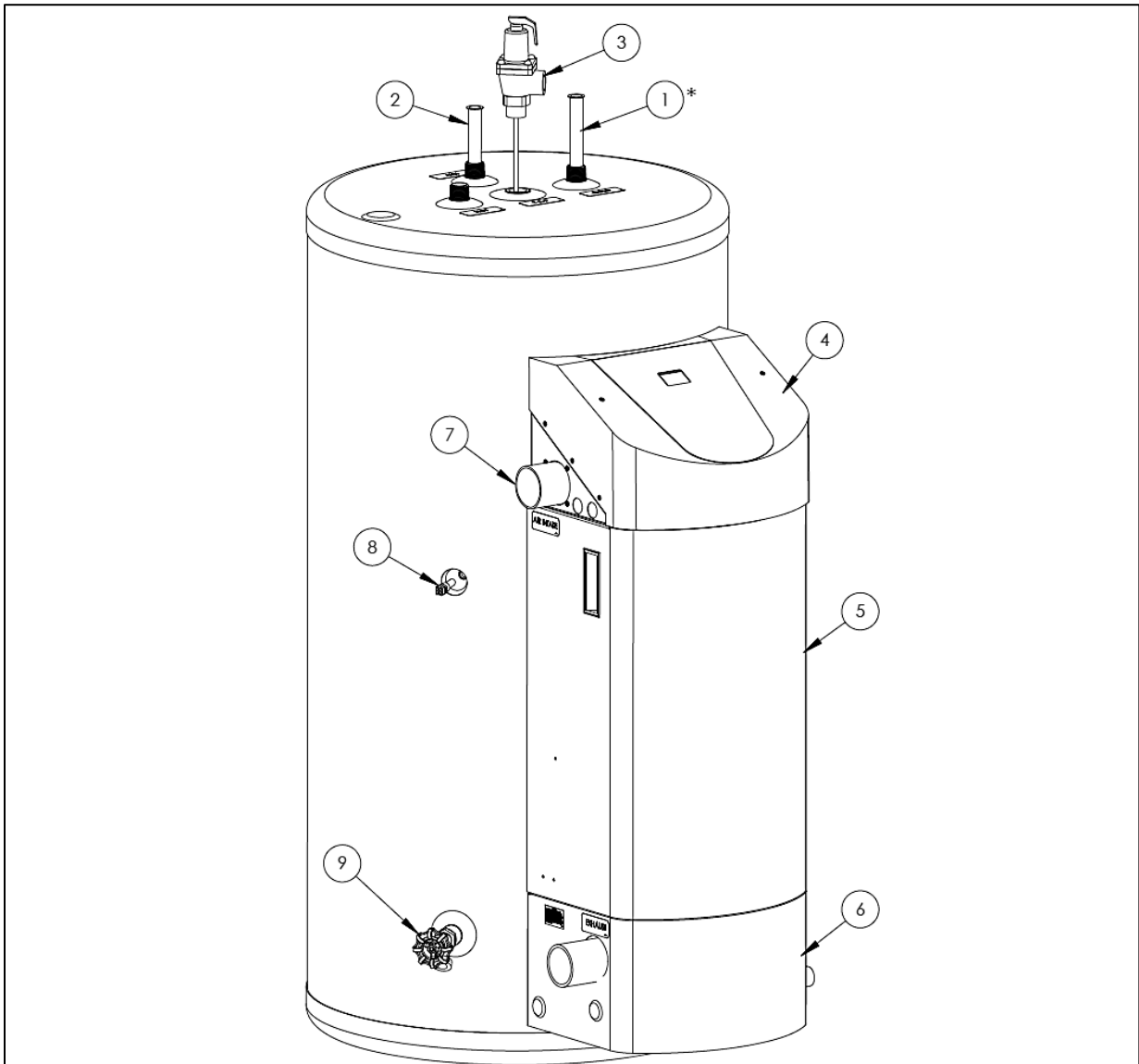

ITEM #	DESCRIPTION	REPLACEMENT PART #
1	COLD INLET DIP TUBE - 50 GALLON	6070P-038
	COLD INLET DIP TUBE - 60 GALLON	7700P-061
	COLD INLET DIP TUBE - 80 GALLON	7700P-062
2	AUXILIARY DIP TUBE - 50 GALLON	7700P-060
	AUXILIARY DIP TUBE - 60 GALLON	6070P-044
	AUXILIARY DIP TUBE - 80 GALLON	6070P-038
3	TEMP/PRESSURE RELIEF VALVE	TP1700
4	CABINET UPPER PANEL	7700P-082
5	CABINET ACCESS DOOR	7700P-042
6	CABINET LOWER PANEL	7700P-043
7	AIR INLET TUBE w/FLAPPER	7700P-046
8	COMBINATION TEMPERATURE SENSOR	7700P-073
9	BRASS DRAIN VALVE	7100P-278
10*	COLD INLET DIP TUBE (w/VENTURI) - 50 GAL (not shown)	7700P-087
	COLD INLET DIP TUBE (w/VENTURI) - 60 GAL (not shown)	7700P-088
	COLD INLET DIP TUBE (w/VENTURI) - 80 GAL (not shown)	7700P-089

* ITEM #10 IS OPTIONAL

WHL-001-R
06/19/14

Figure 26 – Replacement Parts

PART 12 - MAINTENANCE

CAUTION

In unusually dirty or dusty conditions, care must be taken to keep water heater cabinet door in place at all times. Failure to do so VOIDS WARRANTY!

WARNING

Allowing the water heater to operate with a dirty combustion chamber will hurt operation. Failure to clean the heat exchanger as needed by the installation location could result in water heater failure, property damage, personal injury, or death. Such product failures ARE NOT covered under warranty.

WARNING

Hydrogen gas can build up in a hot water system served by this water heater that has not been used for a long period of time (generally two weeks or more). When opening a hot water faucet in a system that has been out of use for a time, keep all ignition sources (electrical appliances, open flame, etc.) away from the faucet. If hydrogen is present, there will be a sound of air escaping as water begins to flow. Allow the water to run for a few minutes to dissipate built up hydrogen from the system. Failure to follow these instructions can result in property damage, personal injury, or death.

The water heater requires minimal periodic maintenance under normal conditions. However, in unusually dirty or dusty conditions, periodic vacuuming of the cover to maintain visibility of the display and indicators is recommended.

Periodic maintenance should be performed once a year by a qualified service technician to assure that all the equipment is operating safely and efficiently. The owner should make necessary arrangements with a qualified heating contractor for periodic maintenance of the heater. Installer must also inform the owner that the lack of proper care and maintenance of the heater may result in a hazardous condition.

NOTICE

It is extremely important that whenever work is performed on the plumbing system that either:

- The water heater is powered off, or,
- The water heater is valved off and isolated from the plumbing system.

Failure to take these measures could result in a dry-firing condition.

WARNING

The water heater must be full of water and the system fully purged BEFORE powering the water heater. Performing any work in the plumbing system without either powering off the water heater or isolating the water heater through the use of shut-off valves could result in a condition referred to as "dry-firing". Dry-firing the water heater will damage the heat exchanger, and could result in property damage, serious personal injury, or death. Such damages ARE NOT covered by water heater warranty.

INSPECTION ACTIVITIES		DATE LAST COMPLETED			
		1 st YEAR	2 nd YEAR	3 rd YEAR	4 th YEAR*
PIPING					
Near heater piping	Check heater and system piping for any sign of leakage; make sure they are properly supported.				
Vent	Check condition of all vent pipes and joints. Ensure the vent piping terminations are free of obstructions and blockages.				
Gas	Check Gas piping, test for leaks and signs of aging. Make sure all pipes are properly supported.				
SYSTEM					
Visual	Do a full visual inspection of all system components.				
Functional	Test all functions of the system (Heat, Safeties)				
Temperatures	Verify safe settings on heater or Anti-Scald Valve				
Temperatures	Verify programmed temperature settings				
ELECTRICAL					
Connections	Check wire connections. Make sure they are tight.				
Smoke and CO detector	Verify devices are installed and working properly. Change batteries if necessary.				
Circuit Breakers	Check to see that the circuit breaker is clearly labeled. Exercise circuit breaker.				
CHAMBER/BURNER					
Combustion Chamber	Check burner tube and combustion chamber coils. Clean according to maintenance section of manual. Vacuum combustion chamber. Replace any gaskets that show signs of damage.				

Spark Electrode	Clean. Set gap at 1/4". Clean probe with plumbers cloth to remove oxides.				
Combination Ignitor and Flame Probe	Check ionization in uA (i04 in the Inquiry Mode menu). Record high fire and low fire. Clean probe with plumbers cloth to remove oxides.				
CONDENSATE					
Neutralizer	Check condensate neutralizer. Replace if necessary.				
Condensate hose	Disconnect condensate hose. Clean out dirt. Fill with water to level of outlet and re-install. (NOTE: Verify the flow of condensate, making sure that the hose is properly connected during final inspection.)				
GAS					
Pressure	Measure incoming gas pressure (3.5" to 10" W.C. Natural Gas, 8" to 14" W.C. LP)				
Pressure Drop	Measure drop in pressure on light off (no more than 1" W.C.)				
Check gas pipe for leaks	Check piping for leaks. Verify that all are properly supported.				
COMBUSTION					
CO/CO2 Levels	Check CO and CO2 levels in Exhaust (See Start-up Procedures for ranges). Record at high and low fire.				
SAFETIES					
ECO (Energy Cut Out)	Check continuity on Flue and Water ECO. Replace if corroded.				
Sensors	Check wiring. Verify through ohms reading per Table 14.				
FINAL INSPECTION					
Check list	Verify that you have completed entire check list. WARNING: FAILURE TO DO SO COULD RESULT IN SERIOUS INJURY OR DEATH.				
Homeowner	Review what you have done with the homeowner.				

Table 19 - *Continue annual maintenance beyond the 4th year as required.

ADDITIONAL INSTALLATION REQUIREMENTS FOR THE COMMONWEALTH OF MASSACHUSETTS

In the Commonwealth of Massachusetts, the installer or service agent shall be a plumber or gas fitter licensed by the Commonwealth.

When installed in the Commonwealth of Massachusetts or where applicable state codes may apply; the unit shall be installed with a CO detector per the requirements listed below.

5.08: Modifications to NFPA-54, Chapter 10

(1) Revise NFPA-54 section 10.5.4.2 by adding a second exception as follows:

Existing chimneys shall be permitted to have their use continued when a gas conversion burner is installed, and shall be equipped with a manually reset device that will automatically shut off the gas to the burner in the event of a sustained back-draft.

(2) Revise 10.8.3 by adding the following additional requirements:

(a) For all side wall horizontally vented gas fueled equipment installed in every dwelling, building or structure used in whole or in part for residential purposes, including those owned or operated by the Commonwealth and where the side wall exhaust vent termination is less than seven (7) feet above finished grade in the area of the venting, including but not limited to decks and porches, the following requirements shall be satisfied:

1. INSTALLATION OF CARBON MONOXIDE DETECTORS. At the time of installation of the side wall horizontal vented gas fueled equipment, the installing plumber or gasfitter shall observe that a hard wired carbon monoxide detector with an alarm and battery back-up is installed on the floor level where the gas equipment is to be installed. In addition, the installing plumber or gasfitter shall observe that a battery operated or hard wired carbon monoxide detector with an alarm is installed on each additional level of the dwelling, building or structure served by the side wall horizontal vented gas fueled equipment. It shall be the responsibility of the property owner to secure the service of qualified licensed professionals for the installation of hard wired carbon monoxide detectors

a. In the event that the side wall horizontally vented gas fueled equipment is installed in a crawl space or an attic, the hard wired carbon monoxide detector with alarm and battery back-up may be installed on the next adjacent floor level.

b. In the event that the requirements of this subdivision cannot be met at the time of completion of installation, the owner shall have a period of thirty (30) days to comply with the above requirements; provided, however, that during said thirty (30) day period, a battery operated carbon monoxide detector with an alarm shall be installed.

2. APPROVED CARBON MONOXIDE DETECTORS. Each carbon monoxide detector as required in accordance with the above provisions shall comply with NFPA 720 and be ANSI/UL 2034 listed and IAS certified.

3. SIGNAGE. A metal or plastic identification plate shall be permanently mounted to the exterior of the building at a minimum height of eight (8) feet above grade directly in line with the exhaust vent terminal for the horizontally vented gas fueled heating appliance or equipment. The sign shall read, in print size no less than one-half (1/2) inch in size, "GAS VENT DIRECTLY BELOW, KEEP CLEAR OF ALL OBSTRUCTIONS".

4. INSPECTION. The state or local gas inspector of the side wall horizontally vented gas fueled equipment shall not approve the installation unless, upon inspection, the inspector observes carbon monoxide detectors and signage installed in accordance with the provisions of 248 CMR 5.08 (2)(a) 1 through 4.

(b) EXEMPTIONS: the following equipment is exempt from 248 CMR 5.08 (2)(a) 1 through 4:

1. The equipment listed in Chapter 10 entitled "Equipment Not Required to be Vented" in the most current edition of NFPA 54 as adopted by the Board; and
2. Product Approved side wall horizontally vented gas fueled equipment installed in a room or structure separate from the dwelling, building or structure used in whole or in part for residential purposes.

(c) MANUFACTURER REQUIREMENTS – GAS EQUIPMENT VENTING SYSTEM PROVIDED. When the manufacturer of Product Approved side wall horizontally vented gas equipment provides a venting system design or venting system components with the equipment, the instructions provided by the manufacturer for installation of the equipment and the venting system shall include:

1. Detailed instructions for the installation of the venting system design or the venting system components; and
2. A complete parts list for the venting system design or venting system.

(d) MANUFACTURER REQUIREMENTS – GAS EQUIPMENT VENTING SYSTEM NOT PROVIDED. When the manufacturer of a Product Approved side wall horizontally vented gas fueled equipment does not provide the parts for venting the flue gases, but identifies "special venting systems", the following requirements shall be satisfied by the manufacturer:

1. The referenced "special venting system" instructions shall be included with the appliance or equipment installation instructions; and
2. The "special venting systems" shall be Product Approved by the Board, and the instructions for that system shall include a parts list and detailed installation instructions.

(e) A copy of all installation instructions for all Product Approval side wall horizontally vented gas fueled equipment, all venting instructions, all parts lists for venting instructions, and/or all venting design instructions shall remain with the appliance or equipment at the completion of the installation.

CUSTOMER INSTALLATION RECORD FORM

The following form should be completed by the installer for you to keep as a record of the installation in case of a warranty claim. After reading the important notes at the bottom of the page, please also sign this document.

Customer's Name:	
Installation Address:	
Date of Installation:	
Installer's Code/Name:	
Product Serial Number(s):	
Comments:	
Installer's Phone Number:	
Signed by Installer:	
Signed by Customer:	

IMPORTANT:

Customer: Please only sign after the installer has reviewed the installation, safety, proper operation and maintenance of the system. In the case that the system has any problems, please call the installer. If you are unable to make contact, please contact your Westinghouse Sales Representative.

Distributor/Dealer: Please insert contact details.