

### Warranty and Product Registration

Thor Group is not responsible for incidental or consequential damages. Under no circumstances will Lycan's liability exceed the cost that you paid for the product. Some states do not allow the exclusion or limitation of incidental or consequential damages, so the above limitations or exclusion may not apply to you.

This warranty gives you specific legal rights, and you may also have other rights that vary from state to state. Whenever you call our customer service at 877-288-8099 ( LYCAN Steam Oven ) for technical information and parts sales in the United States or to request service for your appliance, please have your complete model number and serial number ready. The model and serial number can be found on the product data plate. Please enter the information requested in the spaces provided.

Model No. \_\_\_\_\_ Serial No. \_\_\_\_\_

Date of Purchase \_\_\_\_\_ Purchaser \_\_\_\_\_

Dealer \_\_\_\_\_ Suburb \_\_\_\_\_

Town \_\_\_\_\_ Country \_\_\_\_\_

Note: You must provide proof of purchase and installation date for in-warranty service.

#### Online Warranty Registration

You can register to activate your product warranty online to receive full benefit of Thor Group warranty service at [www.thorkitchen.com/registration-page/](http://www.thorkitchen.com/registration-page/)

Please rest assured that under no conditions will Thor Kitchen sell your name or any of the information you provide to us. We are very grateful that you have chosen THOR Kitchen products for your home.

## Instructions of Steam Oven

# LYCAN

### NSO2101

Lycan-5 in1 Countertop 1800-Watt Convection Steam Oven with Touch Control and Rotisserie

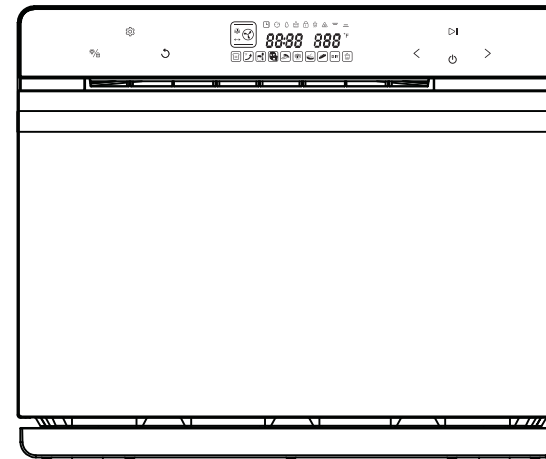

Please refer to the real object

Tips: Please read the Instructions of this product carefully before using this product and properly store it for future reference!

## Contents

Product Structural Diagram .....	1
Notices for Use .....	3
Control Panel .....	4
DISPLAY PCB .....	5
Operating Instructions .....	7
Menu .....	12
Other Functions .....	13
Cleaning and maintenance .....	15
Accessories .....	15
Specification .....	15
Guideline for Troubleshooting .....	16
Warranty .....	17

## Product Structural Diagram

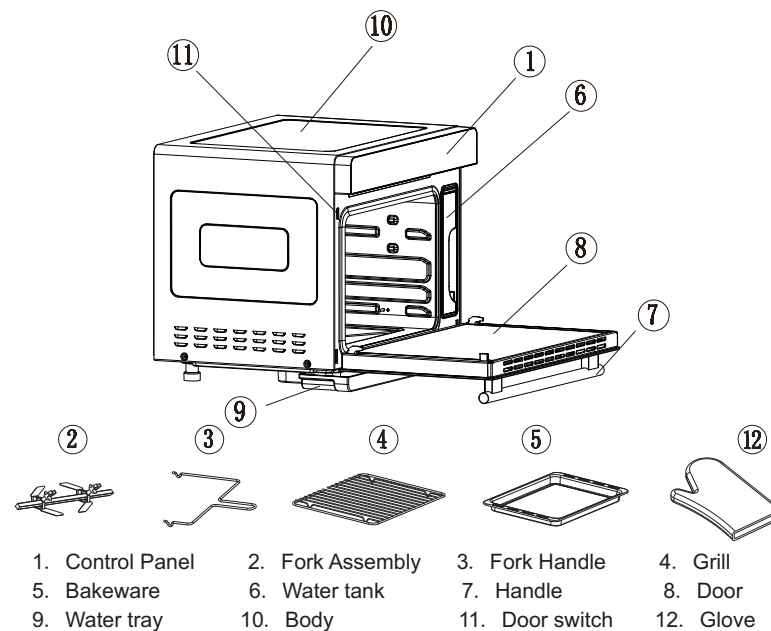

### IMPORTANT SAFEGUARDS

When using electrical appliances, basic safety precautions should always be followed including the following:

1. Read all instructions.
2. Do not touch hot surfaces. Use handles or knobs.
3. To protect against electrical shock do not immerse cord, plugs in water or other liquid.
4. Close supervision is necessary when any appliance is used by or near children.
5. Unplug from outlet when not in use and before cleaning. Allow to cool before putting on or taking off parts.
6. Do not operate any appliance with a damaged cord or plug or after the appliance malfunctions or has been damaged in any manner. Return appliance to the nearest authorized service facility for examination, repair, or adjustment.
7. The use of accessory attachments not recommended by the appliance manufacturer may cause injuries.
8. Do not use outdoors. Household use only.

9. Do not let cord hang over edge of table or counter, or touch hot surfaces.
10. Do not place on or near a hot gas or electric burner, or in a heated oven.
11. Extreme caution must be used when moving an appliance containing hot oil or other hot liquids.
12. Always attach plug to appliance first, then plug cord into the wall outlet. To disconnect, turn any control to "off", then remove plug from wall outlet.
13. Do not use appliance for other than intended use.
14. Oversize foods or metal utensils must not be inserted in a toaster-oven as they may create a fire or risk of electric shock.
15. A fire may occur if the toaster-oven is covered or touching flammable material, including curtains, draperies, walls, when in operation. Do not store any item on top of the appliance when in operation.
16. Do not clean with metal scouring pads. Pieces can break off the pad and touch electrical parts creating the risk of electric shock.
17. Extreme caution should be exercised when using containers constructed of other than metal or glass.
18. Do not store any materials, other than manufacturers recommended accessories, in this oven when not in use.
19. Do not place any of the following materials in the oven: paper, cardboard, plastic or any flammable materials.
20. Do not cover crumb tray or any part of the oven with metal foil. This will cause overheating of the oven.
21. Use extreme caution when removing tray or disposing of hot grease.
22. When the appliance is operating, press the ON/OFF key, the appliance will return to off.
23. 60 minutes "ON" in a two hour period.

**SAVE THESE INSTRUCTIONS.**

### **Warning**

1. Do not rinse the shell of the product in water due to electric in the oven;
2. Do not allow water or other liquids to enter the product to avoid electric shock;
3. This product is not suitable to be used by children under 8 years of age and anyone who has unsound body and sensory or mental disability or lacks of related experiences and knowledge unless they are instructed to use this product and supervised to master the operation methods;
4. Please check whether the voltage of the product matches the voltage of local power supply before the product is connected to the power supply;

5. Do not use this product if the plug, power cord or the product is damaged;
6. If the power cord is damaged, it must be replaced by the manufacturer or its professional service technicians in order to avoid the danger;
7. Please use care and caution when in use around children;
8. Do not use wet hands to insert the plug or operation console of this product;
9. Do not place this product on or near the tablecloths, curtains and other flammable materials;
10. A free space of at least 15cm(5.91in) shall be reserved on the back and two sides and over the product when the product is placed. Do not place any item on the product;
11. The product in use must be watched;
12. A high temperature steam or high temperature airflow will be released when you open its door during or after the cooling operation of the product. A safe distance shall be maintained when the door of the product is opened to avoid the scalding yourself;
13. Do not stuff any foreign matter into door lock switch of the oven door;
14. The recommended temperature probe to this oven must be used;
15. Appliances will heat during the use. Please pay attention to the heating unit in the oven.

### **Notices for Use**

1. Please read all instructions carefully. This product is designed for domestic use only;
2. Do not touch the steam oven while in use because it may have a very high surface temperature; If you need to move the oven, please power off the product first and then use the insulated gloves;
3. The oven cannot be cleaned unless the power plug has been unplugged and the oven is cooled down;
4. The steam oven shall be kept in a dry and flat place with plenty of space around it and a distance of at least 15cm shall be kept away from the surrounding objects when it is used;
5. An overloaded circuit may cause the steam oven to work abnormally when the product used, and therefore, the steam oven shall use a single circuit;

6. Do not put the steam oven near any flammable object. It shall be kept far away from window curtains, door curtains, wallpapers and similar items to prevent a fire. It is not allowed to put any object on the steam oven when it works;
7. Please clean the door glass of the oven with a soft and wet cloth rather than any sharp cleaning tools to prevent the damage to the door glass;
8. The appliance cannot be operated under the circumstances that it connects the external timer or the independent remote control system;
9. Please do not share an outlet with other high-power electrical devices to avoid the fire caused by the overload of the circuit;
10. Please check whether all cooking utensils are suitable for this product before it is used. It is recommended to hold the food with high-temperature glass or ceramic containers; the capacity of holding the liquid food may not exceed two-thirds of the container;
11. It is required to unplug the power plug from the outlet when the oven will not be used for a long time to avoid any electric leakage or fire caused by aging of insulated rubber lines;
12. The power plug shall be unplugged when changing the lights or cleaning the cavity to avoid possible electric shock;
13. The water tank shall not be overfilled with water. Please use it correctly since there is a marked maximum water level scale;
14. The food is not allowed to rely on the horizontal plane of door glass to prevent the product from scalding yourself due to its inclination after the end of cooking operation;
15. Please take out the water tank and allow the residual water of the product to flow out automatically from the product and drain or pour away the water from the bottom water holder after each use of the oven for cooking operation;
16. It is forbidden to heat the food in a sealed container because the sealed container is possible to explode, such as, sealed bottles, boxed milk, etc. It is necessary to tear the package and drop the food into other vessels for heating.

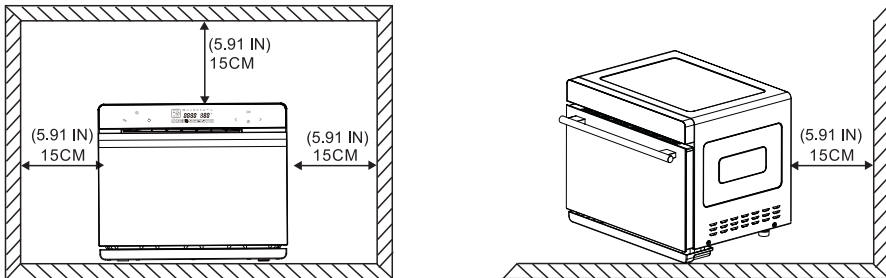

A free space of at least 15cm(5.91in) shall be reserved on the back and two sides and over the product when the product is placed. Do not place any item on the product;

## Control Panel



	Icon	Function Description
01		<b>Oven lamp/child lock key:</b> 1.Touch it once, oven lamp is ON; touch it again, oven lamp goes out; 2.Oven lamp will be ON for three minutes after the work is over; 3.Oven lamp will be ON for three minutes when the oven door is opened; 4.The key turns to child lock by holding it down for three seconds; in the standby mode, hold it down once, it is locked; press it again to unlock.
02		<b>Setting key:</b> preset and time-delay 1. In any programs standby mode, press this key to enter the preset mode and preset icon is ON; 2.After any programs working end, Press this key to enter the time-delay function status and the time-delay icon is ON;
03		<b>BACK key:</b> press this key to return to the previous setting mode before start working, and press it again to return again.
04		<b>Selection key(Reverse function ):</b> 1.Select 9 DIY regular function modes and 10 specific working modes; 2.Adjust the time; 3.Adjust the temperature.
05		<b>ON/OFF key:</b> press this key to activate all icons to light up; In the activation or working status of the machine press this key to exit the running mode, and the machine will return to the standby status.
06		<b>Selection key(Forward function):</b> 1.Select 9 DIY regular function modes and 10 specific working modes in a forwarding sequence; 2.Adjust the time; 3. Adjust the temperature.
07		<b>ENTER key:</b> 1.Start; 2.Pause; 3.Enter.

## DISPLAY PCB



		Function	Description
01		Time	The first two LEDs are hours (0-24) and the second two LEDs are minutes (0-59)
02		Temperature	Adjustable range: 85°F - 450°F
03		Preset function prompt	
04		Working time -delay prompt	
05		Water level icon	Icon is always ON for water; a flashing light means a lack of water.
06		Prompt for cleaning of water tray	
07		Children lock	
08		Prompt for descaling	
9		Top heater pipe	
10		Bottom heater pipe	
11		Prompt for a high temperature	
12		Ferment	
13		Preheat	
14		Making Yogurt	
15		Air Fryer	This menu contains 9 programs and recipes
16		Dry fruit and bake nuts	This menu contains 9 programs and recipes for different fruits and bake different nuts
17		steam menu	This menu contains 9 programs and recipes for different food
18		Roast meat	This menu contains 9 programs and recipes for fish and different meat
19		Bake	This menu contains 9 programs and recipes for different bread cake
20		DIY mode	Baking method and time shall be set by customers themselves
21		Descaling	Remind to clean the scale in the evaporating heater(steam heater)

## Operating Instructions

### 1. First Energization

The machine enters the full-screen standby interface after a “beep” sound when it is energized firstly by touching power ON .

During the setting process, if there is no operation for continuous in three minutes all current settings will be cancelled and the machine will return to the standby interface for a standby status.



### 2. Menu Selection



In the standby status, press the selection key “>” “<” to enter the menu selection mode.

Default menu “” steam function, press selection keys “>” “<” to move left or right to select the menu mode.



- 1) Ferment (steam function, default temperature 105°F, adjustable among 85-120°F; time adjustable among 0-7 hours)
- 2) Preheat (temperature is not adjustable). It is set as 360°F. When the temperature reaches 360°F, the work is over, the display shows “END” and the buzzer will beep for 10 times to prompt that the preheating work is completed and you can continue the baking operation;
- 3) Making Yogurt (default temperature 115°F that is not adjustable, and default time of 8 hours that is not adjustable)
- 4) When this menu “Air Fryer” is selected, icon is ON. The temperature display column will show “P-1”, and meanwhile, the time display column will show the required working time. Press the selection key “>”, the temperature display column will show “P-1”, “P-2”, “P-3” ... “P-9”.. “P-1”, and repeat this circle, and the corresponding time column will show the required time. Press the ENTER key “▷||”, the machine begins to work and the time begins to count down.
- 5) Dry fruits or bake nuts. When this menu is selected, icon is ON, and the temperature display column will show “L-1”, and meanwhile, the time display column will show the required working time. Press the selection key, the temperature display column will show “L-2”, “L-3”, “L-4”, ... “L-9”.. “L-1”, and repeat this circle, and the corresponding time column will show the required time. Press the ENTER key ▷||, the machine begins to work and the time begins to count down.
- 6) When this menu “Steam” is selected, icon is ON. The temperature display column will show “E-1”, and meanwhile, the time display column will show the required working time. Press the selection key “>”, the temperature display column will show “E-1”, “E-2”, “E-3” ... “E-9”.. “E-1”, and repeat this circle, and the corresponding time column will show the required time. Press the ENTER key “▷||”, the machine begins to work and the time begins to count down.



7) When the menu "Roast"  is selected,  icon is ON. The temperature display column will show "F-1", and meanwhile, the time display column will show the required working time. Press the selection key ">", the temperature display column will show "F-1", "F-2", "F-3" ... "F-9". "F-1", and repeat this circle, and the corresponding time column will show the required time. Press the ENTER key, the machine begins to work and the time begins to count down.

8) When the menu "Bake"  is selected,  icon is ON. The temperature display column will show "H-1", and meanwhile, the time display column will show the required working time. Press the selection key ">", the temperature display column will show "H-1", "H-2", "H-3" ... "H-9". "H-1", and repeat this circle, and the corresponding time column will show the required time. Press the ENTER key, the machine begins to work and the time begins to count down.

9) When the menu  is selected, the "steam" function icon in upper left corner is ON. Press the selection key ">" to enter the function selection mode. The display column at the left side of the screen will show the corresponding function icon, as shown in the following figure. There are 9 DIY regular function modes.

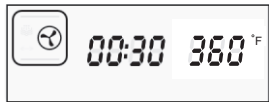
Each gear of the key corresponds to a function. The key moves a gear, the function icon will automatically jump down to flash, and the frame will not flash. After the desired function is selected, it can be confirmed by press the ENTER key .



10) When the menu "Descaling"  is selected, the  icon is ON to remove the scale. (Working time of 50 minutes is not adjustable. The work process cannot be paused)

### 3. Setting of working hours and temperature

After the desired function is selected, it shall be confirmed by pressing the ENTER key to enter the setting of working hours. The hour bit will flash. Press the selection key to set the hour bit. After it is confirmed by pressing the ENTER key, the minute bit will flash, and then press the selection key to set the minute bit. After it is confirmed by pressing the ENTER key, the temperature bit will flash, and then press the selection key to set the working temperature for "Top heater pipe" and "Bottom heater pipe". After the setting of working temperature is finished, press the ENTER key to start working.

For example, the setting of "Top heater pipe" working mode:

1) Select function



2) setting of working hours

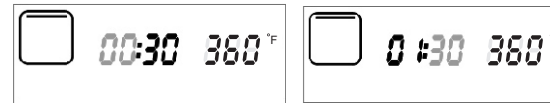

3) Setting of working hours and temperature, top heater pipe icon "≡" will flash.

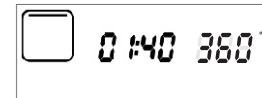

4. Start work

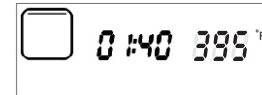

**Attention:** all functions shall be adjusted according to this adjustment order except for the fixed time and temperature.

**Note:** water tank icon will be displayed when a steam-related function is selected (such as, steam, high-temperature steam, ferment, unfreeze etc.), for example:





### 5. During the work

1) Pause

During the working process, the machine will pause the work if the ENTER key  is pressed, the working time will stop the countdown, the display interface will stay in the working state interface, and the time bit number will keep its original data to flash and beat, which indicates that the machine is in a working status of pause. Press the ENTER key again, the machine is started to continue the work until the cooking is completed.

2) Add the time and adjust the temperature in the midway



During the cooking/ Baking / Roasting process, if you want to adjust the cooking time or temperature, the operation is as follows:

- ① Press Setting key  until the "Time-delay" icon  on the screen is ON. At this time, the minute bit will flash. The minute bit can be adjusted by pressing the selection key "<" ">" (setting of hour bit is not available for delay time function).
- ② After the minute bit is adjusted, press the ENTER key to enter the setting of temperature. If you do not need to adjust the temperature, please press the ENTER key to directly start the work;



- ③ After the temperature is adjusted, press the ENTER key to start the work;
- ④ The time-delay “⌚” function is not available for the descaling program. After it is completed, the system directly enters the END interface.









### 6. End of Work

- 1) After the program process is ended, “END” appears on the display screen, and the buzzer will beeps for 10 times, which indicates that the cooking is completed. Afterwards, you can open the door to take out the food or the system will automatically exit to the standby status five minutes later.
- 2) After the program is over or in the standby state, for a pause or stop in the midway, the display screen will show the high-temperature prompt icon  so long as the Oven cavity temperature is over 120°F and The centrifugal fan will delay the working time for 3 minutes.
- 3) After the program is completed with the steam function,  icon will flash on the screen, which remind the user to take out the water tank and drain the water in the evaporator, and then pour away the residual water from water holder. This icon will flash for 1 minute.

**Note: removal of residual water and icon display are available only when there are steam-related functions while evaporating heater is working.**

### 7. DIY function modes



1		Steam
2		Strengthening heating (Back heater convection + top heater pipe + bottom heater pipe)
3		Top Heater pipe
4		Top/bottom heater pipe
5		Hot air convection (top Heater pipe + rear fan)
6		Back heater convection (Back heating + rear fan)
7		High-temperature steaming (steam + Back heater convection)
8		Back heater convection + turning fork
9		Top Heater pipe + turning fork

### 1) DIY Steam

Adjustable temperature range: 120-230°F, with each adjusting scale of 40°F. In the standby status, open the oven door, take out the water tank to fill the water to its maximum scale; put in the water tank and food and then close the oven door.

Press the selection key “>” to enter the steam mode. At this time, the steam icon  will flash, and the indicator light of water tank/time/temperature is ON. Press the ENTER key, hour icon will shine. Press the SELECTION key to select the time as required (default value is 0, ranging from 0-6). After it is selected, press the ENTER key to enter the minute selection mode and then, the minute icon will flash. Press the SELECTION key to select the required time (default value is 30, ranging from 0-59). After it is selected, press the ENTER key to enter the temperature selection mode and then, the temperature icon will flash. Press the SELECTION key to select the required temperature (default value is 210, ranging from 120-230). After the selection, press the ENTER key.

If the water tank is not put in or runs out of water, the machine will give an alarm (icon “⚠” flashing and audible alarm); if there is a water shortage alarm, please open the oven door to add water and then close the door to automatically start the work.

After the steam function is completed, the user shall be prompted to drain the residual water from the water holder and  icon will flash on the screen to remind the user to drain the residual water from the water holder.

After the end of the cooking, the buzzer will beep for 10 times and then stop. Afterwards, user can open the door to take out the food. If there is no operation within five minutes, the system will automatically return to the standby interface.

### 2) DIY Other Roast Modes

Adjustable temperature range: 210-450 °F. The default working temperature is 360 °F, and the time is adjustable.

Open the oven door in the standby state, put in the food and then close the door. Press the Selection key to enter the roast mode. The icon of this mode will flash, and the indicator light of time/temperature is ON. Press the ENTER key, the “hour” icon will flash. Press the Selection key to select the required time (default value is 0, ranging from 0-3). After it is selected, press the ENTER key to enter the minute selection mode and then, the minute icon will flash. Press the SELECTION key to select the required time (default value is 30, ranging from 0-59). After it is selected, press the ENTER key to enter the temperature selection mode and then, the temperature icon will flash. Press the SELECTION key to select the required temperature (default value is 360, ranging from 210-450). After the selection, press the ENTER key, the indicator light of Bottom heating pipe is ON and the temperature icon will flash. Press the SELECTION key to select the required temperature (default value is 360, ranging from 210-450). After pressing the ENTER key , the machine starts to work.

After the end of the cooking, the buzzer will beep for 10 times and then stop. Afterwards, user can open the door to directly take out the food. If there is no operation within five minutes, the system will automatically return to the standby interface.

After the cooking is completed, a high-temperature indication “” will be displayed as long as the temperature of cavity exceeds 120°F.

## Menu

### 1. “Steam” menu

Code	E-1	E-2	E-3	E-4	E-5	E-6	E-7	E-8	E-9
Food Style	Steam Vegetable	Steam Rice	Steam Fish	Steam Shrimp	Steam Crab	Steam Eggs	Steam Chicken	Steam Papaya	Steam Potatoes
Heating time (minute)	16	50	20	15	30	16	30	35	30
Heating temperature (°F)	210	210	210	210	210	210	210	210	210

### 2. “Roast” menu

Code	F-1	F-2	F-3	F-4	F-5	F-6	F-7	F-8	F-9
Food Style	Roast Chicken	Roast Steak	Roast Muttons	Roast Salmon	Roast Chicken legs	Roast Saury	Roast Chips	Roast Shrimp	Roast Sausages
Heating time (minute)	35	12	35	20	26	20	12	15	10
Heating temperature (°F)	450	450	395	430	395	430	360	360	395

### 3. “Bake” menu

Code	H-1	H-2	H-3	H-4	H-5	H-6	H-7	H-8	H-9
Food Style	Baguette bread	Wheat bread	Pizza	Yogurt cheese cake	Chiffon cake	Chocolate cake	Cookies	Puff	Egg tart
Heating time (minute)	16	20	22	60	50	50	14	32	22
Heating temperature (°F)	360	360	360	300	300	300	360	360	360

### 4 “Air Fryer” menu

Code	P-1	P-2	P-3	P-4	P-5	P-6	P-7	P-8	P-9
Food Style	Pork Chops	Chicken Wings	Chicken Kabobs	Onion Meatballs	Pita Chips	Chips	Croutons	Mini Pizza	Bacon
Heating time (minute)	20	23	18	18	7	12	14	18	15
Heating temperature (°F)	410	395	355	410	430	360	285	355	395

### 5. “Dry Fruits and bake Nuts” menu

Code	L-1	L-2	L-3	L-4	L-5	L-6	L-7	L-8	L-9
Food Style	Dry Banana	Dry Apple	Dry Raisins	Dry Kiwi	Dry lemon	Almonds	Walnut	Macadamia Nut	Cashew Nut
Heating time (minute)	360	360	420	360	360	10	12	12	12
Heating temperature (°F)	150	150	195	150	150	285	320	320	320
Working mode	back Heater	back Heater	back Heater	back Heater	back Heater	Top/bottom Heater pipe	Top/bottom Heater Pipe	Top/bottom Heater Pipe	Top/bottom Heater Pipe

## Other Functions

### ■ Descaling function:



Default time is 50 minutes, which is not adjustable.

- When the accumulated working time of heating pipe of evaporating heater reaches 100 hours, the system will remind the user to remove the scale of evaporating heater (user can also start the descaling function automatically). At this moment, the descaling icon on the screen will flash.



- The descaling mixture (water and clearing media) is prepared according to the mixing ratio of 1:8 and then put into the water tank after an even mixing. The dosage of descaling mixture in the water tank may not be lower than the descaling scale of water tank.
- After the descaling mixture or agent is added into the water tank and the oven door is closed, press the SELECTION key to select the descaling function and then press the ENTER key to start the descaling work.
- The countdown mode is used for the product. When there are still 20 minutes, the user is reminded to pull out the water tank to drain the descaling agent and replace the clean water. After the water tank is inserted, the machine begins to work. When there are still 10 minutes, the user is reminded again to pull out the water tank to replace the clean water. After the water tank is inserted, the machine begins to work. After the completion, the user will be prompted.

### ■ Setting Key function

- 1. Presetting time:** During any program selection or standby mode, Press Setting Key , it will start preset time setting, and Icon  is on, the Hour LED flashing (Preset time is 0-24 hours adjustable), after hour confirmed, the Minute LED flashing, after minute confirmed, Interface return to program selection mode, press > < key select program, after Program selected, press the ENTER key  to start this selected program Presetting; After presetting time starting, the preset time interface and selected program interface will display Alternately every 5 seconds;



2. **Time-Delay:** When any program working completed, press this key to enter the "Time-delay" function, can add time and adjust temperature accordingly, and the "Time-delay" icon is ON; Press the ENTER key to confirm it.  icon in the screen is ON, which indicates that the system is in this working status currently.
3. On DIY mode, press this key to adjust time and temperature any time, After adjusting the time, press the ENTER key to confirm it and start working;



If the Setting function shall be ended, user can directly press the POWER key to exit from the setting working mode and the system will automatically return to the standby interface.

#### ■ Lighting function

After the key is activated, the illuminating light will be ON for 3 minutes by pressing the key Lighting/Child Lock, and it will go out by pressing the key again.

#### ■ Children Lock

After entering the working state, children lock icon is ON by holding down the key Lighting/Children Lock, and all keys or buttons are locked. They cannot be unlocked unless user holds down the key Lighting/Children Lock again.

#### ■ Water level detection protection

When the working state of steam mode is started, if water shortage is detected, the machine will stop the work and the buzzer will give an alarm, and then all keys or buttons are invalid. The machine resumes the work after the water is added.

#### ■ Open/close protection of oven door

In the door-opening state, the startup becomes unavailable; during the working process, the machine suspends the work if user opens the oven door. The machine automatically resumes the work after the oven door is closed.

## Cleaning and maintenance

1. Please turn off the steam oven and unplug the power cord from the outlet before cleaning the cavity;
2. Do not clean the bakeware surface with metal tool or grinding material because there is a non-sticky coating on the surface.
3. Please keep the cavity clean frequently. When good or grease is splashed onto the inner wall, it can be wiped with a damp cloth rather than any hard substance. If the inner wall of the oven is dirty, user can clean it with soft lotion rather than rough and abrasive lotion;
4. It is recommended to use the pure water or distilled water for the cooking purpose of the steam oven. If the tap water is used for a long time, there will be scale on the inner walls of the cavity;
5. The water tank shall be checked regularly. If necessary, the water tank shall be taken out horizontally. The water tank shall be cleaned and wiped gently with a soft cloth. After the wiping or cleaning of the inner wall, the water tank shall be put back to its original place.
6. After the cooking is completed, the residual water in the water holder shall be removed.
7. The sealing surface of the oven door shall be cleaned frequently and wiped with a soft dry cloth.
8. If the steam oven will not be used for a long time, the power plug shall be unplugged and the cavity shall be cleaned and then the steam oven shall be placed in a dry environment without corrosive gas.
9. The product must be repaired by a professional service center for any failure. Do not disassemble and overhaul it by yourself.
10. Do not clean the glass of oven door with a rough detergent or sharp metal scraper because it may lead to the smashing of the glass.
11. The power cord shall be unplugged when cleaning the cavity or replacing the bulb.
12. Do not use the steam cleaner.

## Accessories

NO.	Part Name	Qty
1	Grill	1
2	Bakeware	1
3	Fork Handle (For 40L only)	1
4	Fork Assembly(For 40L only)	1
5	Glove or Handle	1
6	Instruction Manual	1

## Specification

Capacity (L)	Rated Power (W)	Voltage (V)	Frequency (Hz)	Water tank (L)
36 /40	1800	120	60	1.4

## Guideline for Troubleshooting

Abnormal conditions	Possible causes	Solution
Er1	Open circuit for top sensor	Stop the work, open the oven door and allow the cavity to cool down for 10 minutes, and then restart it or contact the after-sales service.
Er2	Short circuit for top sensor	Stop the work, open the oven door and allow the cavity to cool down for 10 minutes, and then restart it or contact the after-sales service.
Er3	Open circuit for down sensor	Stop the work, open the oven door and allow the cavity to cool down for 10 minutes, and then restart it or contact the after-sales service.
Er4	Short circuit for down sensor	Stop the work, open the oven door and allow the cavity to cool down for 10 minutes, and then restart it or contact the after-sales service.
Er7	Open circuit for evaporating heater sensor	Contact the after-sales department for repair
Er8	Short circuit for evaporating heater sensor	Contact the after-sales department for repair
No display on the screen	1. Check whether the power supply plug is plugged; 2. Display panel in poor contact	1. Re-energize; 2. Contact the after-sales department for repair
Oven lamp does not light	1. Oven lamp is damaged 2. Poor contact	1. Replace or contact the after-sales department for repair 2. Contact the after-sales department for repair
Exhaust fan does not work	1. Poor contact 2. Fan is damaged	1. Replace or contact the after-sales department for repair 2. Contact the after-sales department for repair
No response from the button	PCB is failed or damaged	Contact the after-sales department for repair
No steam	1. Water pipe is blocked 2. Evaporator heater is damaged 3. Water intake system is damaged	Contact the after-sales department for repair
Steam oven does not work	1. Door is not closed tightly 2. Poor contact of door control switch	1. Re-close the oven door; 2. Contact the after-sales department for repair
Steam leakage from oven door	1. Door is not closed in place 2. Door sealant is off or damaged 3. Door structure is damaged or not assembled in place	Contact the after-sales department for repair

## Warranty

This product has been manufactured by Thor Group, 13831 Oaks Ave, Chino, California 91710. Thor Group disclaims all express warranties except for the following: This warranty applies to products purchased and located in the United States. Products purchased or located outside this area are excluded. The warranty does not apply to damage resulting from abuse, accident, natural disaster, loss of electrical power to the product for any reason, alteration, outdoor use, improper installation, and improper operation, repair or service of the product by anyone other than an authorized Thor Group, service agency or representative.

### Warranties and Duration

#### 1-year Parts Warranty.

Implied warranties terminate upon expiration of the limited warranty. Some states do not allow limitations on how long implied warranty lasts, so the above limitation may not apply to your implied warranty.

#### Thor Group will pay for:

Cost of replacement parts found to be defective due to material and workmanship.

For Customer Service/ Technical Support, please call Thor Customer Service Number at 877-288-8099.

#### Thor Group will not pay for:

#### This limited warranty does not cover:

1. Cost to replace or repair house fuses, and to correct the house wiring or the installation for your steam oven.
  2. Parts Cost when your Steam Oven is used for other than normal, single-family household use or when it is used in a manner that is contrary to published user or operator instructions and/or installation instructions.
  3. Cosmetic damage, including chips, dents, scratches or other damage to the finish of your Steam Oven, unless such damage results from defects in materials or workmanship and is reported to Thor Group within 30 days from the date of purchase.
  4. Damage resulting from misuse, alteration, accident, abuse, fire, flood, acts of God, improper installation, installation not in accordance with electrical, or use of consumables or cleaning products not approved by Thor Group.
  5. Cost of consumable parts. Consumable parts are not included in the warranty coverage.
    - 1). Serial number that have been removed, altered or cannot be readily determined;
    - 2). Product that has been transferred from its original owner to another party or outside the USA or Canada;
    - 3). Rust on the interior or exterior of the unit;
    - 4). Products purchased "as-is" are not covered by this warranty;
    - 5). Products used in a commercial setting;
    - 6). Damages to the finish of appliance or home incurred during installation, including but not limited to floors, cabinets, walls, etc.;
    - 7). Damages caused by: services performed by unauthorized service companies; use of parts other than genuine Thor parts or parts obtained from persons other than authorized service companies; or external causes such as abuse, misuse, inadequate power supply, accidents, fires, or acts of God;
- The warranty applies to appliances purchased and used for personal, family or household purposes only. It does not cover appliances used for commercial applications. Should the appliance be sold by the original purchaser during the warranty period, warranty shall extend to the new owner until the expiration date of the original purchaser warranty period.