

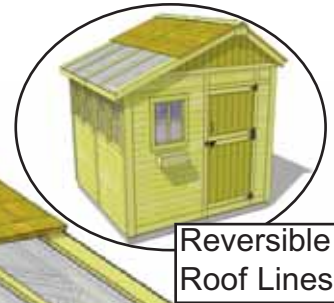

# 8x8 Sunshed Garden Shed Assembly Manual

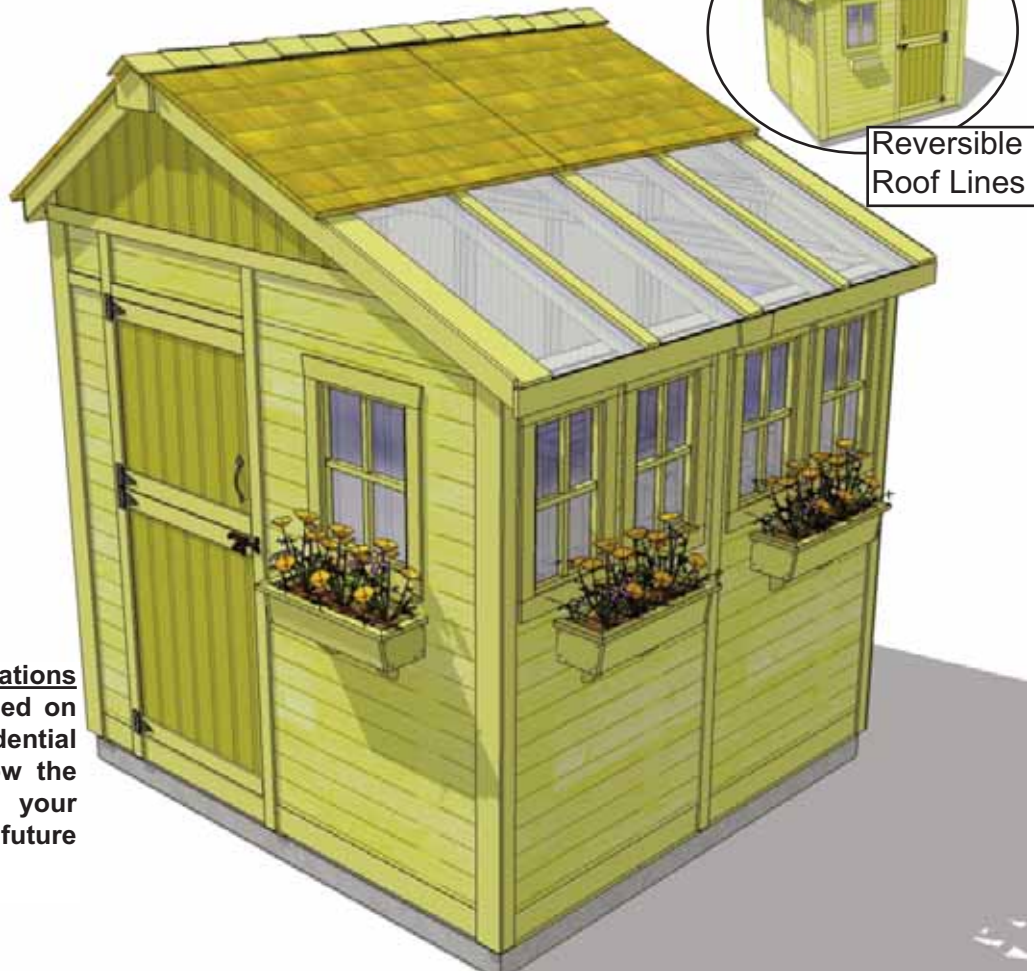

Thank you for purchasing an 8x8 SunShed Garden Shed from Outdoor Living Today. Please take the time to identify all the parts prior to assembly.



## Safety Points and Other Considerations

Our products are built for use based on proper installation and normal residential use, on level ground. Please follow the instruction manual when building your shed and retain the manual for future maintenance purposes.

Some of the safety and usage measures you may wish to consider include:

- snow load ratings vary by geographical location. If heavy or wet snowfall occurs, it is advisable to sweep the snow off the roof(s).
- if the product is elevated, any structural and building code requirements are solely the customer's responsibility, and should be abided by.
- in high or gusty wind conditions it is advisable to keep the structure securely grounded.
- have a regular maintenance plan to ensure screws, doors, windows and parts are tight.

Customer agrees to hold Outdoor Living Today Partnership and any Authorized Dealers free of any liability for improper installation, maintenance and repair.

**In the event of a missing or broken piece, simply call the Outdoor Living Today Customer Support Line @ 1-888-658-1658 within 30 days of the delivery of your purchase. It is our commitment to you to courier replacement parts, free of charge, within 10 business days of this notification. Replacement parts will not be provided free of charge after the 30 day grace period.**

Thank you for purchasing our 8x8 Sunshed Garden Shed.  
Please take the time to identify all the parts prior to assembly.

## Parts Lists: 8x8 Sunshed

### A. Floor Section

- 2 - 45 1/2" x 75" - Floor Joist Frames (Interior Joist Unattached)
- 2 - 45 1/2" x 21" - Floor Joist Frames (Interior Joists Attached)
- 4 - 1 1/2" x 3 1/2" x 71 3/4" - Floor Joists
- 2 - 45 3/8" x 74 7/8" - Floor Plywood
- 2 - 45 3/8" x 20 7/8" - Floor Plywood
- 5 - 1 1/2" x 3 1/2" x 60" - Floor Runners - Long
- 5 - 1 1/2" x 3 1/2" x 31" - Floor Runners - Short

### B. Wall Section

#### Main Wall Panels

- 3 - 45 1/2" x 75" - Solid Wall Panels
- 3 - 1 1/2" x 2 1/2" x 45 1/2" Wall Plates
- 2 - 45 1/2" x 75" - Window Wall Panels
- 2 - 45 1/2" x 75" - Double Window Walls
- 1 - 12" x 73" - Narrow Wall Panel
- 1 - 31 1/2" x 72" Dutch Door - 2pcs (42" and 30" high)
- 4 - 45 1/2" x 9" - Wall Extensors
- 2 - 47 1/2" x 9" - Angled Wall Extensors for Front & Back - L/R
- 3 - 3/4" x 3 1/2" x 60" - Horizontal Wall Extendor Brace
- 2 - 3/4" x 3 1/2" x 30" - Horizontal Wall Extendor Brace (front/back)
- 1 - 3/4" x 3 1/2" x 26" - Horizontal Wall Extendor Brace (side)

#### Door Jamb, Header & Door Stops

- 1 - 1 1/2" x 3" x 73" - Vertical Door Jamb
- 1 - 2" x 3" x 45 1/2" - Door Header
- 2 - 1/2" x 2 1/2" x 72" - Interior Vertical Door Stops

#### Gable Walls

- 2 - Front and Rear Gable Walls - Triangular shaped (33 3/4 degrees on 1 side / 22 1/2 degrees on other)
- 2 - Triangular Gable Trims - (tacked to 22 1/2 degree Gables) ((L /R) Found stapled to inside of Gable in each corner)

#### Top Wall Plates

- 1 - 3/4" x 2 1/4" x 86" - Double Window Wall Side - 22 deg. cut on edge
- 1 - 1 1/2" x 2 1/4" x 86" - Solid Wall Side - 33.75 deg. cut on edge
- 2 - 3/4" x 2 1/2" x 73 3/4" Front & Rear (33 3/4 degrees on 1 end / 22 1/2 degrees on other)

### C. Rafter Section

- 6 - 1 1/2" x 3 1/2" x 77 3/4" - Long Roof Side Rafters (22 1/2 degrees)
- 6 - 1 1/2" x 3 1/2" x 37 3/4" - Short Roof Side Rafters (33 3/4 degrees)
- 1 - 3/4" x 4 5/8" x 33 1/2" - Ridge Boards (long roof side)
- 1 - 3/4" x 4 5/8" x 57 1/2" - Ridge Boards (long roof side)
- 1 - 3/4" x 5 1/8" x 33 1/2" - Ridge Boards (short roof side)
- 1 - 3/4" x 5 1/8" x 57 1/2" - Ridge Boards (short roof side)
- 3 - 3/4" x 3 1/2" x 72" - Gussets (angle cut on both ends)

#### Soffits

- 2 - 1/2" x 3 1/2" x 45 1/2" Short Roof Side
- 2 - 1/2" x 4 1/2" x 45 1/2" Long Roof Side

### D. Roof Section

- 4 - 3/4" x 1 1/2" x 30" - F&R Roof/Facia Nailing Strips
- 2 - Right Side Roof Panels
- 2 - Left Side Roof Panels
- 8 - 3/4" x 3/4" x 44 1/2" - Polygal Support Cleats
- 2 - 1/2" x 2 1/2" x 41 1/2" - Mid Ridge Caps for Polygal
- 1 - 1/2" x 3 1/2" x 41 1/2" - Center Ridge Cap for Polygal
- 2 - 1/2" x 5 1/2" x 41 1/2" - Outside Caps for Polygal (w nailing strip)
- 4 - 20 1/4" w x 44" - Polygal Panels

### E. Miscellaneous Section

#### Bottom Skirting

- 8 - 1/2" x 4 1/2" x 45 1/4" - Bottom Skirting

#### Corner & Wall Trim

- 2 - 1/2" x 2 1/2" x 75" - Filler Trim Short Wall Side
- 2 - 1/2" x 2 1/2" x 84" - Filler Trim Tall Wall Side
- 2 - 1/2" x 4 1/2" x 82" - Corner Trim Short Wall Side
- 2 - 1/2" x 4 1/2" x 87" - Corner Trim Tall Wall Side
- 3 - 1/2" x 2 1/2" x 87" - Front Door Trim & Rear Wall Seam Trim
- 3 - 1/2" x 2 1/2" x 88" - Tall Wall Vertical Trim
- 3 - 1/2" x 2 1/2" x 79" - Short Wall Vertical Trim
- 1 - 1/2" x 2 1/2" x 32" - Horizontal Door Trim (above Door)
- 1 - 1/2" x 2 1/2" x 8 3/4" - Horizontal Narrow Wall Trim (above Wall)
- 2 - 1/2" x 4 1/2" x 85 1/2" - Hor.Gable Trim (F & R) Angle cut 1 end

#### Facia Trim

- 2 - 3/4" x 3 1/2" x 78 3/4" - Angle Cut Front/Rear Facia Trim
- 2 - 3/4" x 3 1/2" x 38 1/4" - Angle Cut Front/Rear Facia Trim
- 4 - 3/4" x 3 1/2" x 49" - Side Facia
- 2 - Facia Detail Plates (sides)
- 2 - Pentagon Detail Plates (front and back)

#### Filler Shingles (5 1/2" wide)

- 4 - Long Shingles
- 2 - Short Shingles

#### Ridge Caps

- 1 Bundle - (15 Cedar Shingle Roof Ridge Caps 1 -10" Center Ridge Caps )

#### Flower Boxes

- 4 - Flower Box Kits

#### Potting Shelves

- 2 - Long Potting Shelves
- 1 - Short Potting Shelf
- 6 - 1 1/2" x 2 1/2" x 35" - Potting Shelf Legs

#### Window Inserts/Trim

- 2 Reg. Window Inserts
- 4 Small Window Inserts
- 2 Reg. Window Trim Pkg: 1 x 24 1/16" top, 3 x 23" bottom & sides
- 4 Sm. Window Trim Pkg: 1 x 19 7/8" top, 2 x 21 7/16" sides, 1 x 18 3/4" bottom

#### \*\*Miscellaneous Pieces

- 1 pc - Spare Wall Siding
- 2 pcs - Spare Shingles - use to shim door, etc.

Note: All Trim, Facia and Bottom Skirting pieces will be positioned rough face out when installed.

# 8x8 SUNSHED HARDWARE SHEET

## Hardware Kit (Provided)

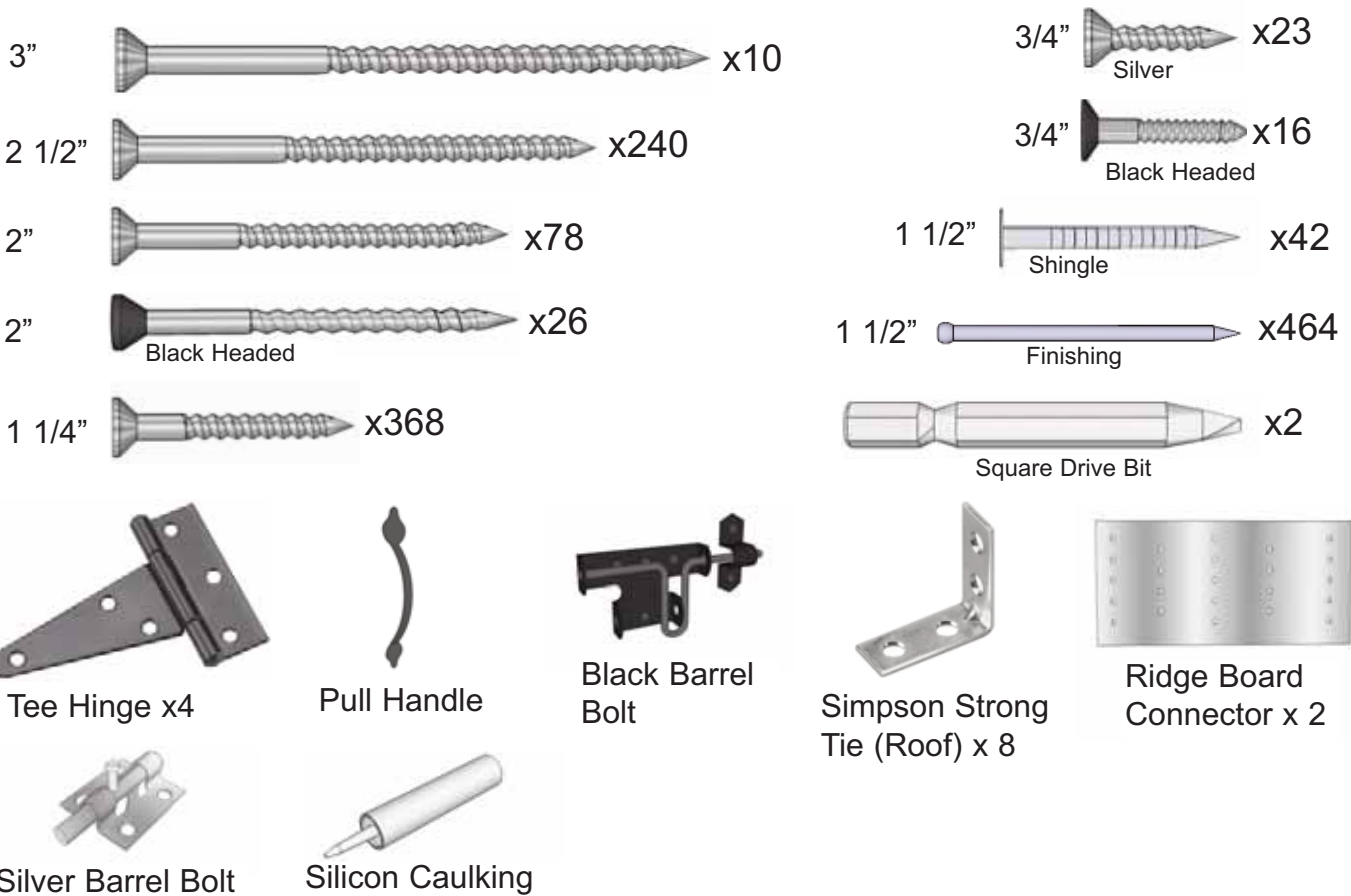

## Tools Required (Not Provided)



## Safety Equipment Required (Not Provided)



# A. Floor Section

Exploded view of all parts necessary to complete Floor Section. Identify all parts prior to starting. Note: Floor Footprint is 96" wide x 91" deep.

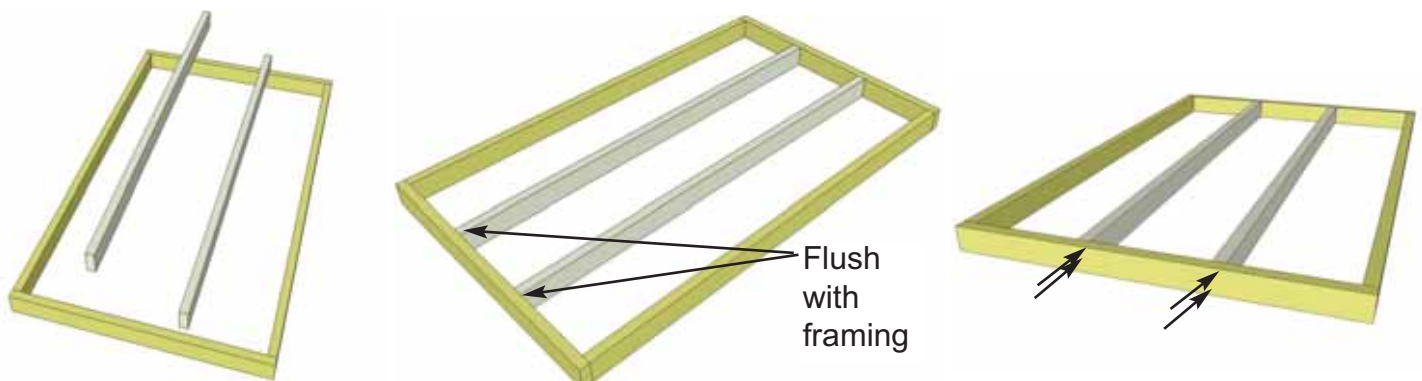
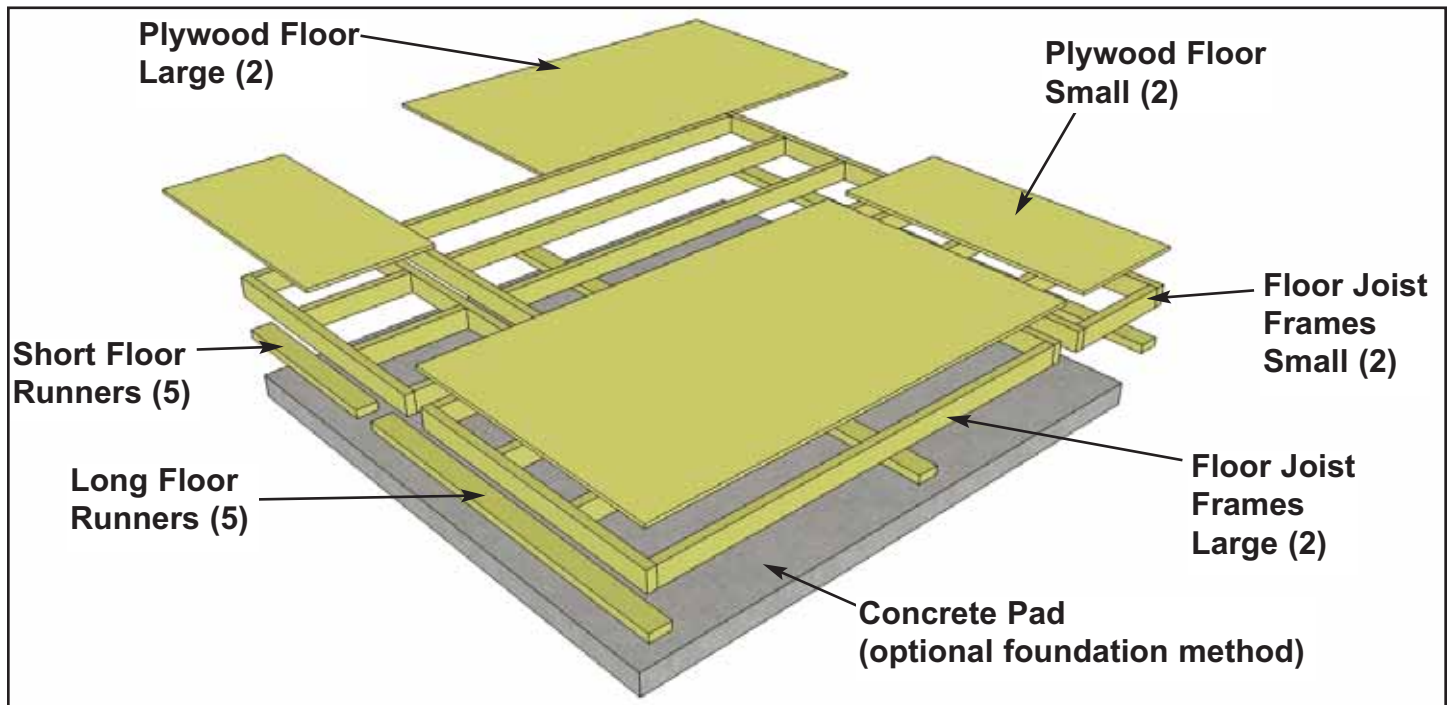

**1.** Lay out **Large Floor Joist Frame and 2 Floor Joists**. Position Joists equally in Floor Joist Frame. Use **Small Floor Joist Frame** as a template to determine joist position. Position Joist flush with framing. When correctly positioned, attach each Joist with 4 - 2 1/2" screws.

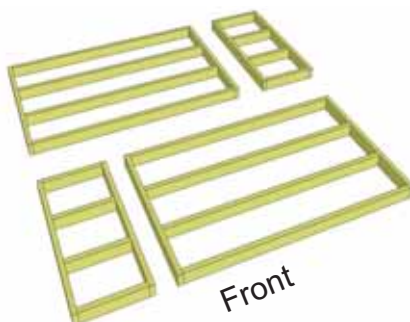

You can find the Square Drive Bit for the screws in with the Hardware Kit Bag.

If reversing roof and walls, also reverse Floor Frames.

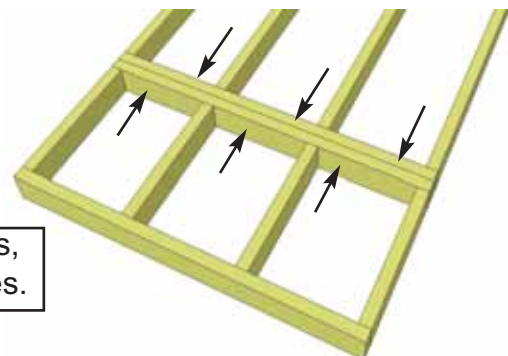

**2.** Lay out **Floor Joist Frames** as illustrated above. There are 2 larger and 2 smaller Frame Sections. The Footprint for the floor when attached together will be 96" wide x 91" deep.

**3.** Attach each large and small floor joist frames together with 6 - 2 1/2" screws per section.

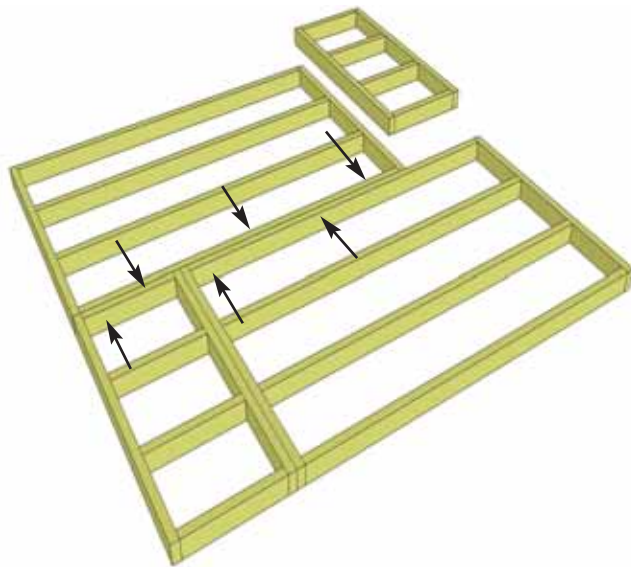

**4.** Complete all large and small frame attachments. Screw each completed section together with 8 - 2 1/2" screws.

**5.** When completed, your floor footprint should be 96" wide x 91" deep.

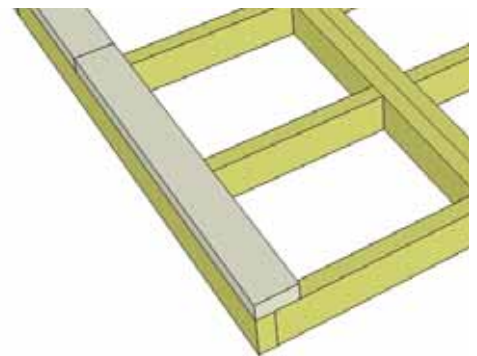
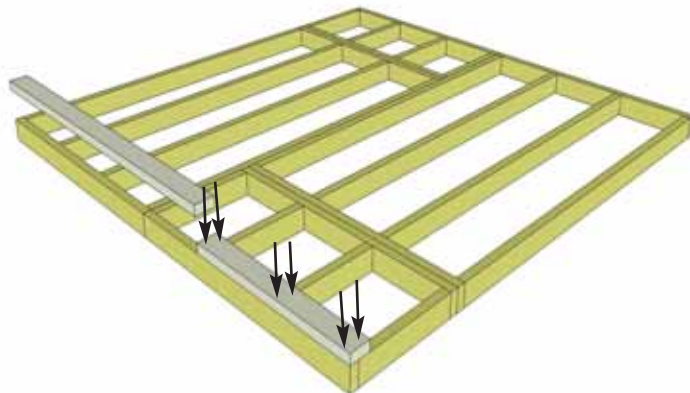
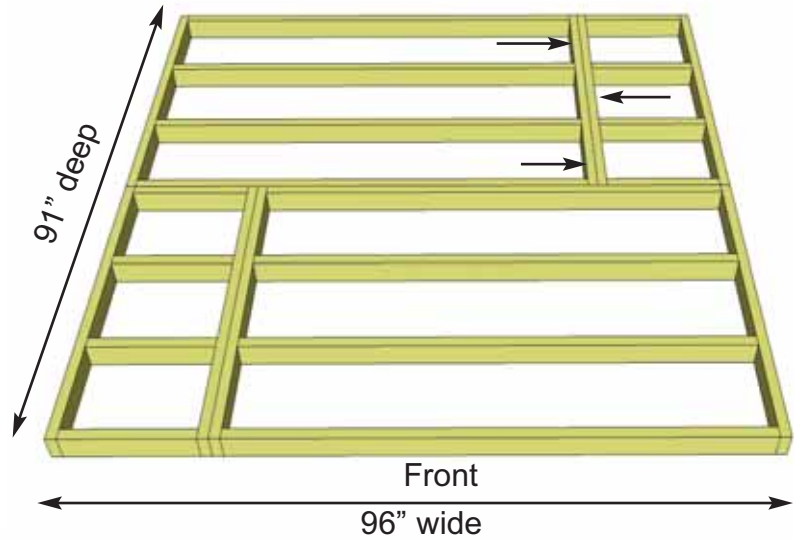

**6.** Attach **Floor Runners** to completed floor frame. There are 2 floor runners per 91" side and 5 completed runners in total. Use 6 - 2 1/2" screws per Runner.

**7.** Make sure Runners are flush with floor framing and not overhanging.

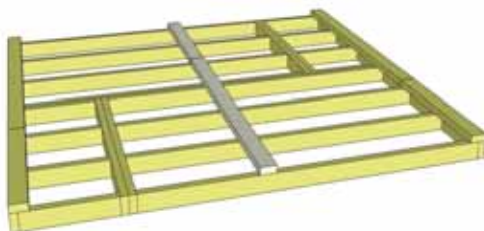

**8.** Complete all Floor Runners, alternating long and short.

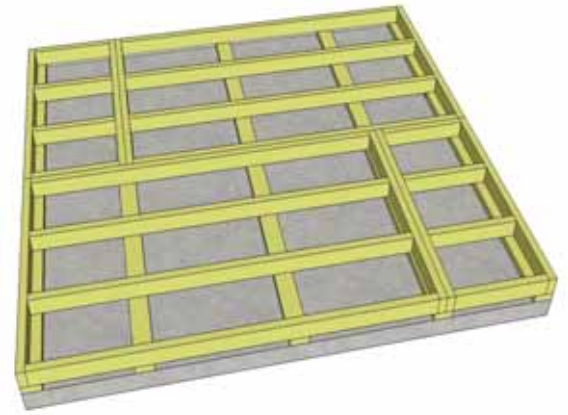
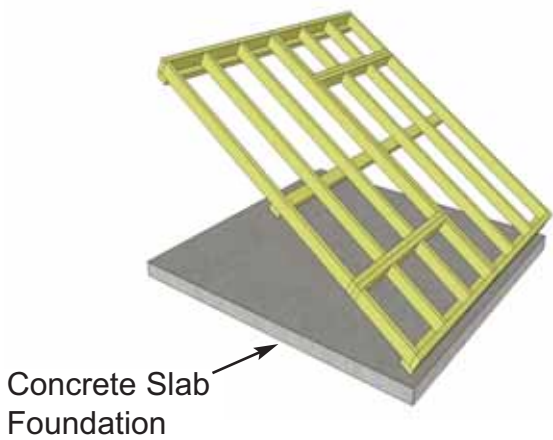

**9.** With Floor Runners attached, carefully flip the floor over and place on your foundation. **Caution:** you will need 2 people to assist you. Be careful when laying floor down not to bend or twist floor. When in place, level floor completely.

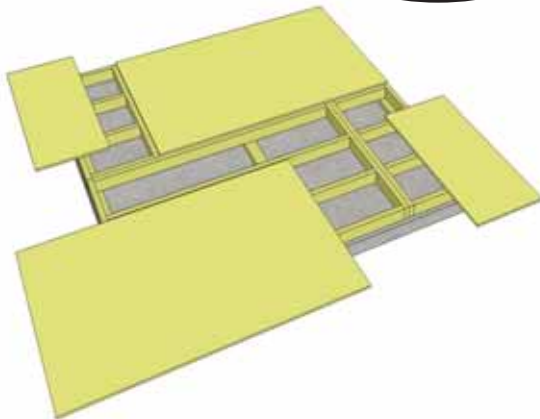
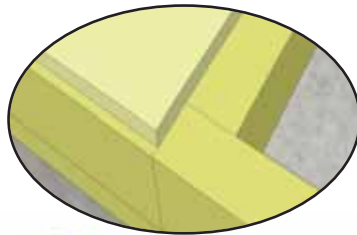

**10.** Position **Plywood Floor** pieces (4) on top of completed Floor Joists. Plywood will sit slightly back from outside edge of Floor Joist Framing. **The Plywood is cut slightly smaller than floor framing. Keep plywood seams tight.**

**Hint:** Use a chalk line to mark location of floor joists to determine screw placement.

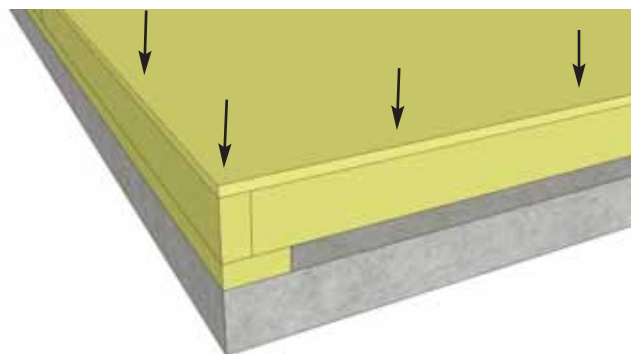
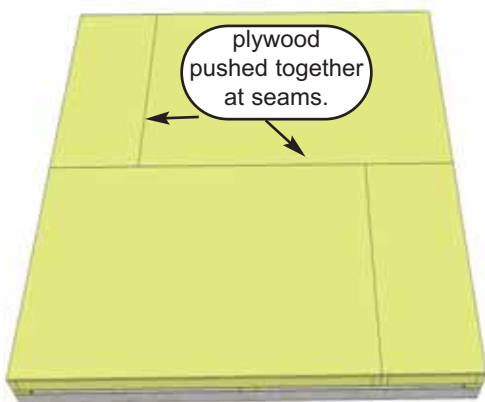
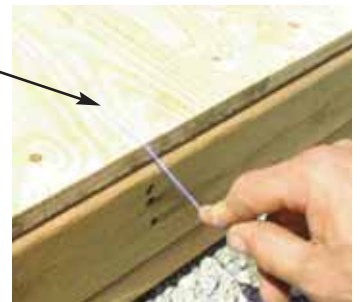

**11.** With Plywood positioned correctly on floor framing, attach with 1 1/4" screws. Use screws every 16".

# B. Wall Section

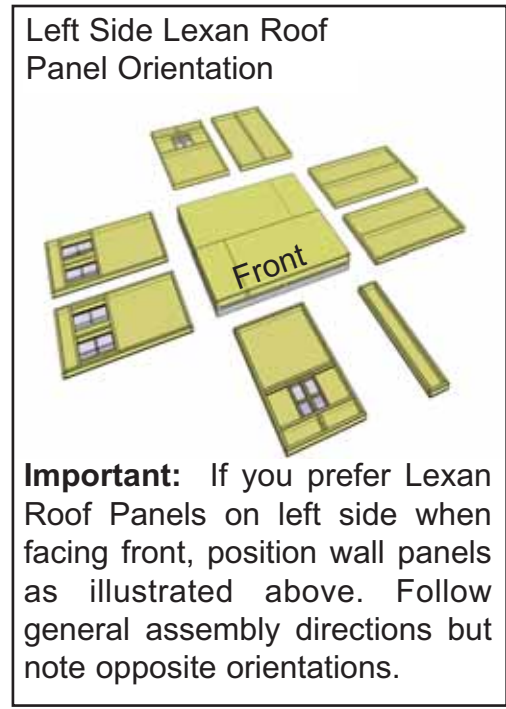
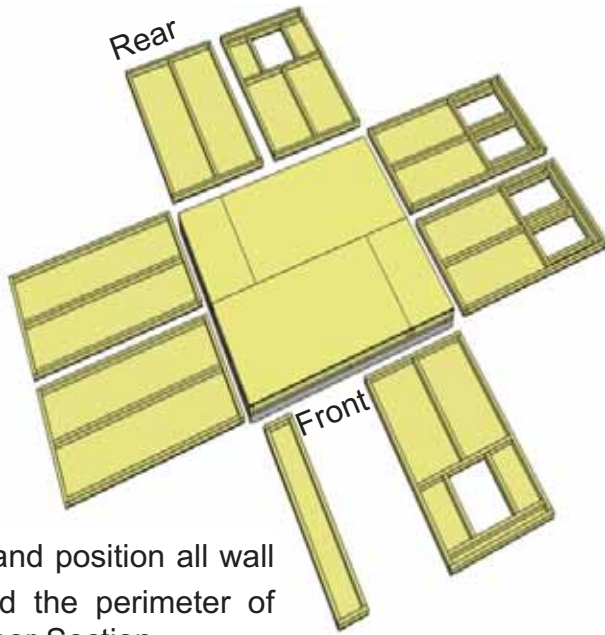

**12.** Locate and position all wall panels around the perimeter of completed Floor Section.

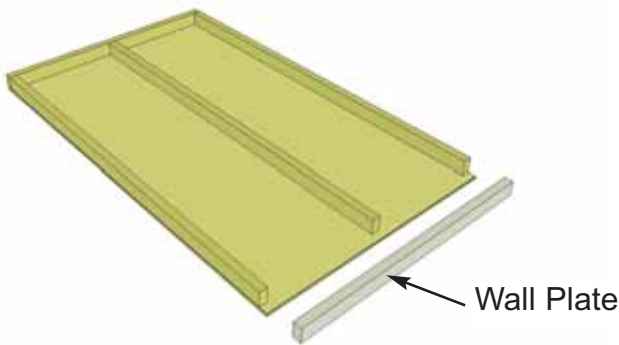

**13.** Locate 3 **Solid Wall Panels** and 3 **Wall Plates**. Attach Plates to bottom of wall studs of each wall panel with 3 - 2 1/2" screws. Position so plates are flush with framing.

**Do Not Attach Walls To Floor until Step 31.**

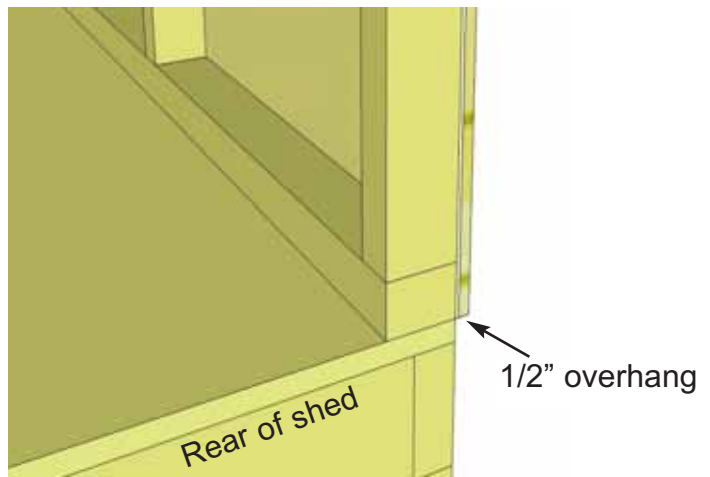
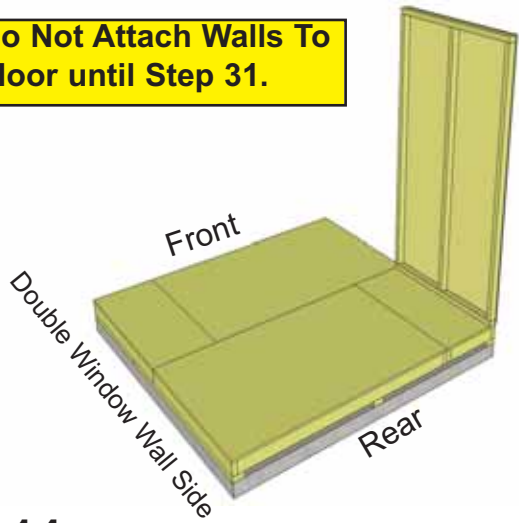

**14.** Position a **Solid Wall Panel** upright on the floor. Make sure wall siding is facing upright. See window walls for correct direction of siding. Position panel so wall framing is flush with floor joist framing. Siding of wall will overhang the floor by approximately 1/2".

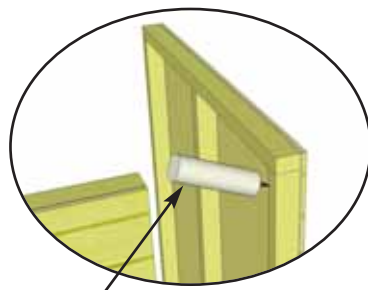
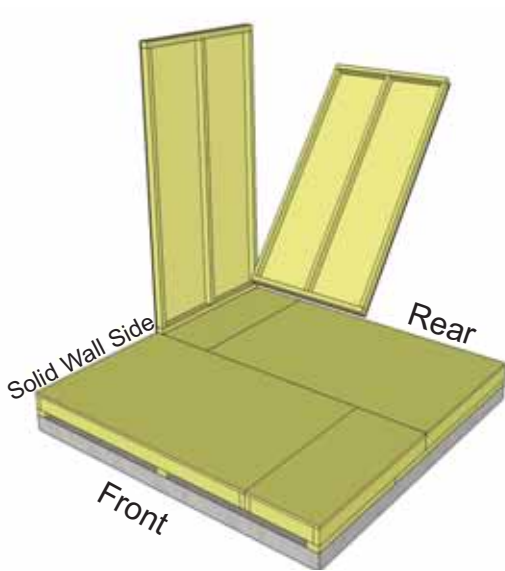

**Optional:** Caulking seams will help prevent moisture from entering your shed. Caulking is included to complete Lexan Windows only. Additional Caulking may be required for seams.

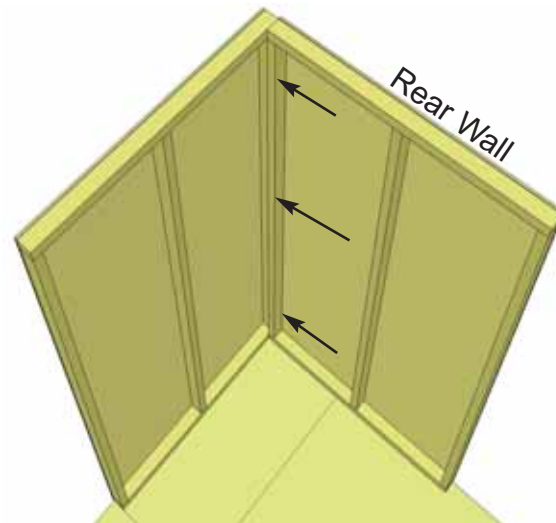

**15.** Place a second Solid Wall Panel in the corner, positioning the wall framing flush with floor frame.

**Note:** Rear walls (and front walls) will be positioned between side walls. Align vertical wall frames and attach with 3 - 2 1/2" screws at bottom, middle and top. Have helper hold wall panels while securing.

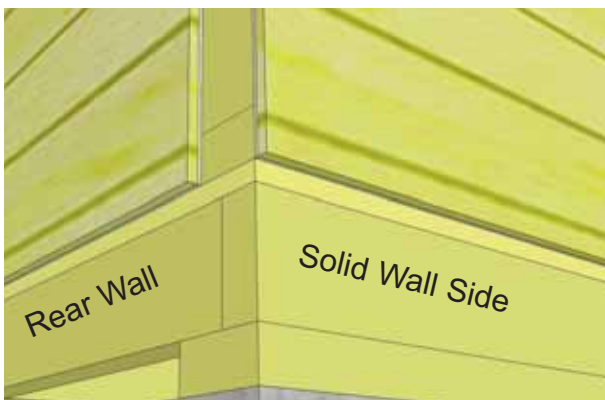

View of Rear Corner showing Solid Wall Side and Rear Wall orientation. Note how the Wall 2x3 bottom framing is flush to floor while siding overhangs floor.

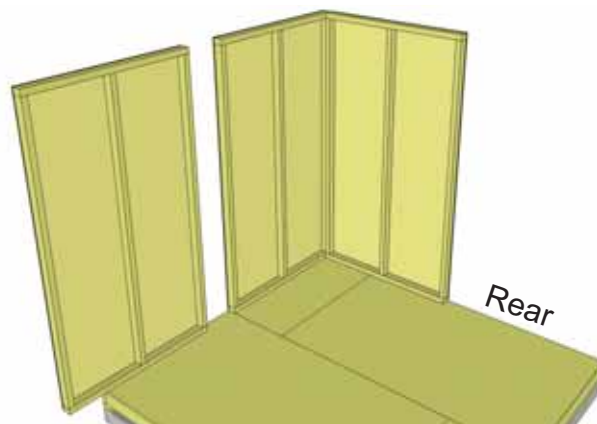

**16.** Lift and place a third Solid Wall Panel on floor.

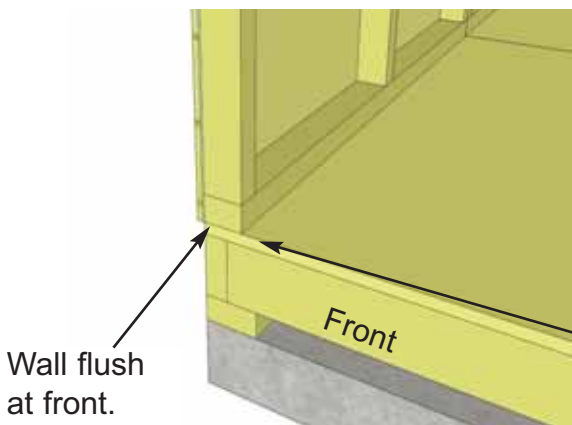

**17.** Position and attach third wall panel. Secure vertical wall frames together with 3 - 2 1/2" screws. 2x3 wall framing of panel will sit flush with floor framing.

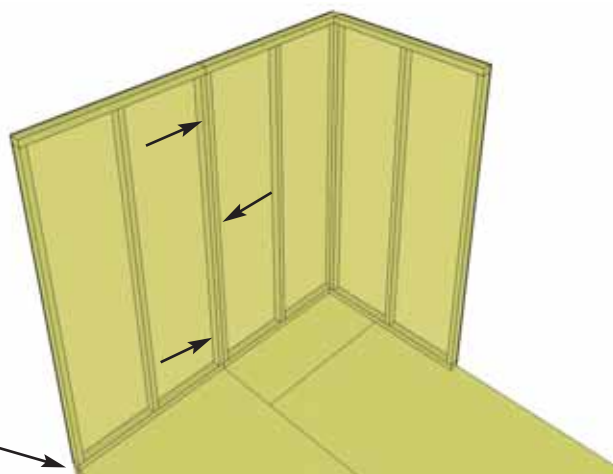



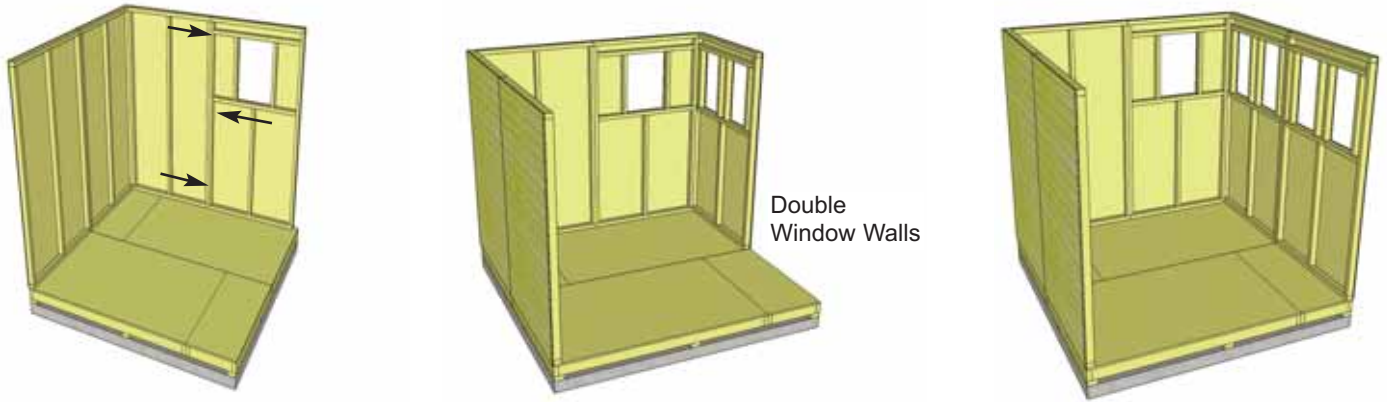

**18.** Continue adding wall panels around the Sunshed. Align panels on floor as per **Step 14 - 17**. Use 3 - 2 1/2" screws to secure each panel together.

**19.** Position and attach **Narrow Wall Panel** to left side wall framing with 3 - 2 1/2" screws as per **Step 15**. **Note:** Narrow Wall is 73" high (2" shorter than wide walls).

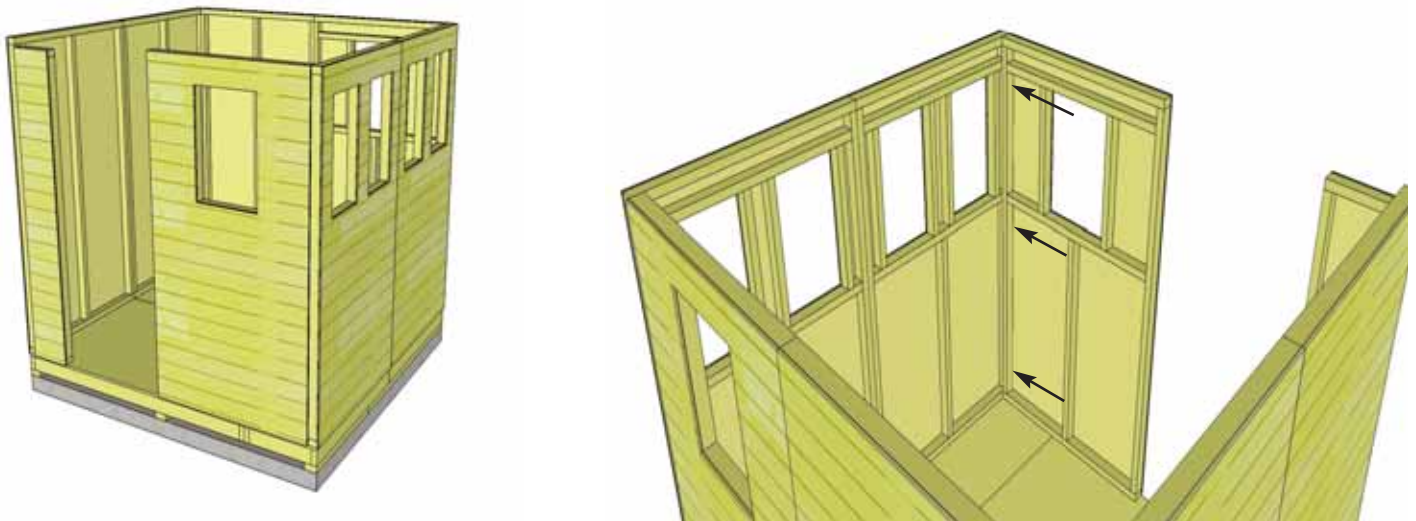
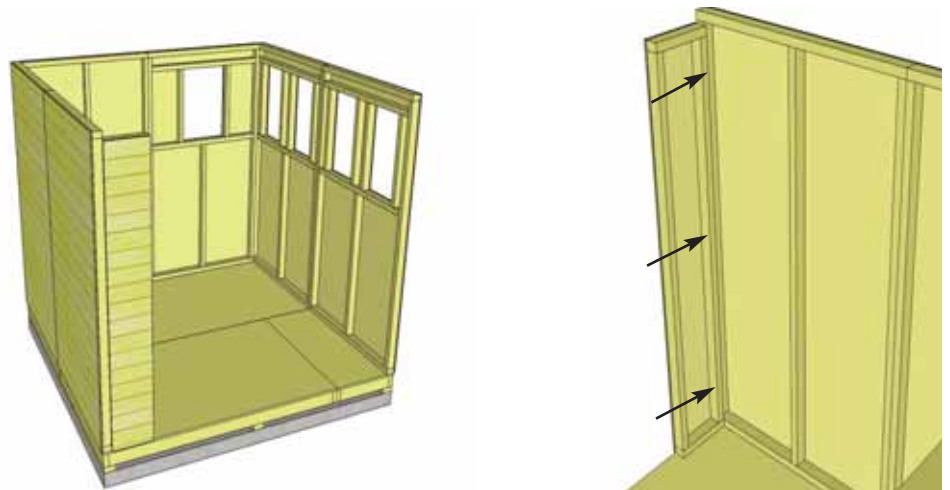

**20.** Position front Window Wall Panel and attach as per **Step 15**.

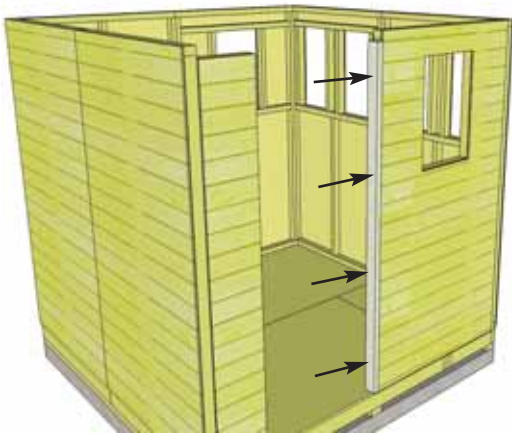

Flush with inside of wall stud and outside siding.

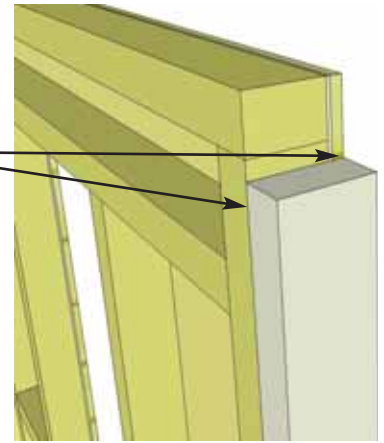

**21.** Locate **Vertical Door Jamb** (1 1/2" x 3" x 73") and position flush against right wall panel stud. The Jamb is 3" wide and will sit flush to outside of wall siding. When positioned correctly, secure Jamb using 4 - 2 1/2" screws.

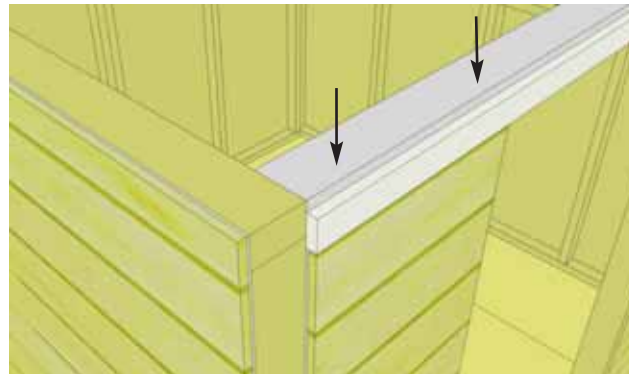
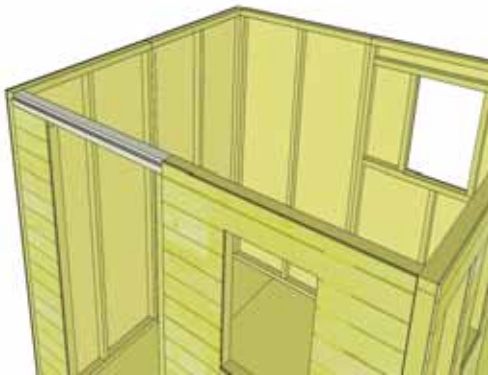

**Note:** Door Header has cleat attached, place with cleat on top and "notch" facing outward

**22.** Position and attach the **Door Header** (2" x 3" x 45 1/2") to Door Jamb and Narrow Wall Panel top framing. Header should sit flush with Door Jamb and Outside of Narrow Wall Panel Siding. Attach with 4 - 2 1/2" screws.

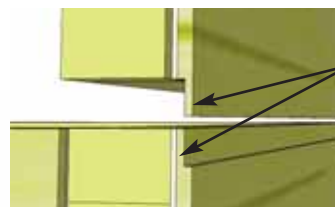

From outside, Lap Siding of panels will fit together.

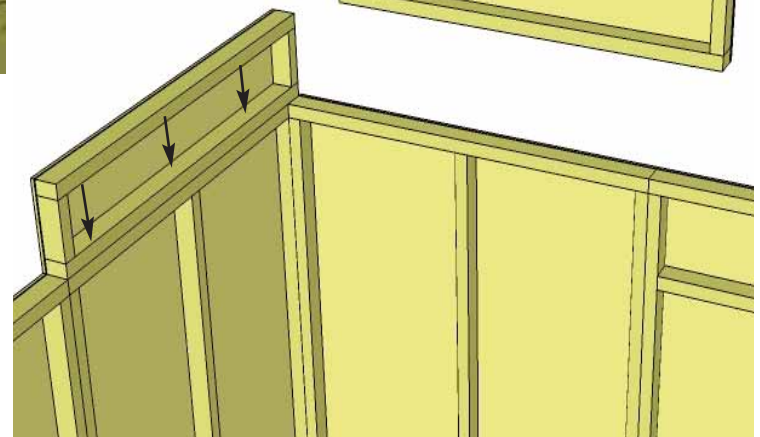
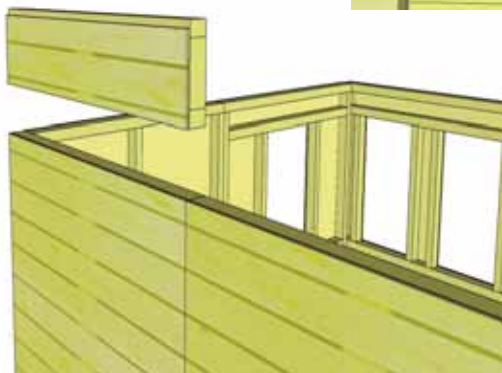
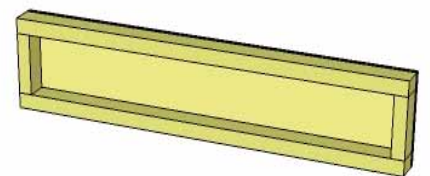

**23.** Locate and place **Wall Extenders** on top of rear left corner. Align so 2x3 framing lines up with framing of walls. When correctly in place, secure each with 3 - 2 1/2" screws in bottom framing. Secure vertical wall framing of extenders with 2 - 2 1/2" screws. **See Diagram Step 24.**

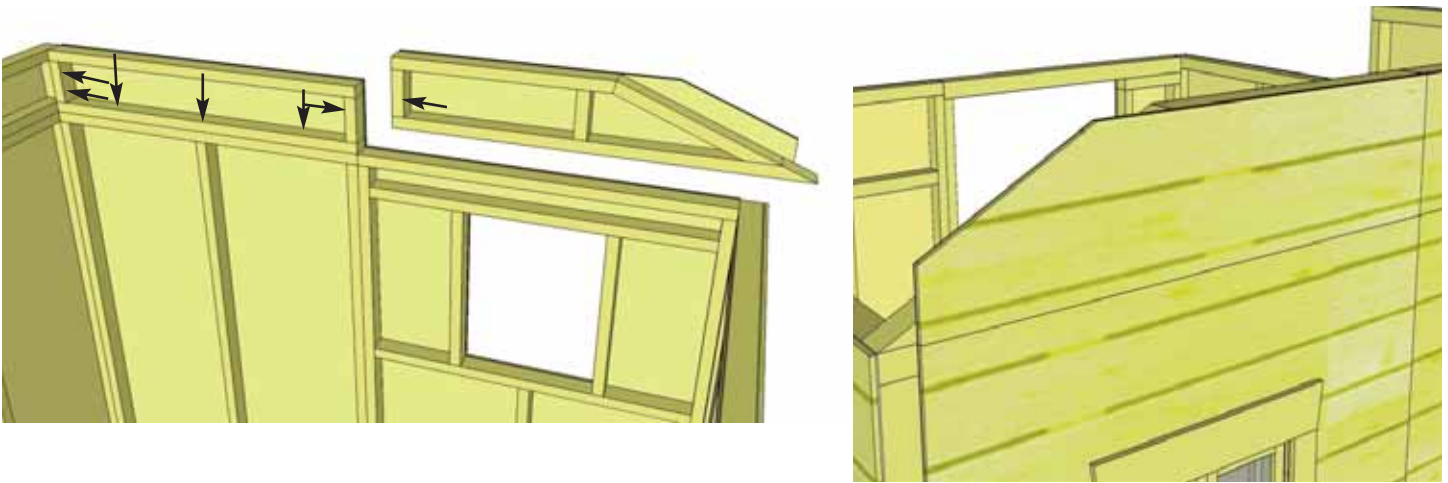

**24.** Locate and position an **Angled Wall Extendor** on the rear wall of Sunshed. Align once again so 2x3 frame lines up with previously installed Wall Extendor and regular wall panel. When correctly in place, secure with 5 to 6 - 2 1/2" screws.

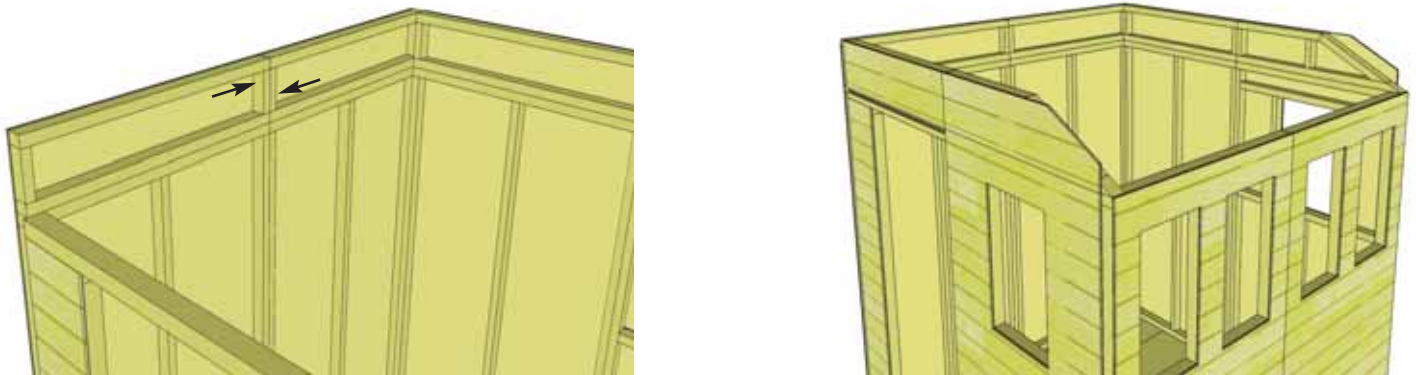

**25.** Align and attach remaining Wall Extendors as per **Step 23-24**. **Note:** Wall Extendors are not required for the double window wall side.

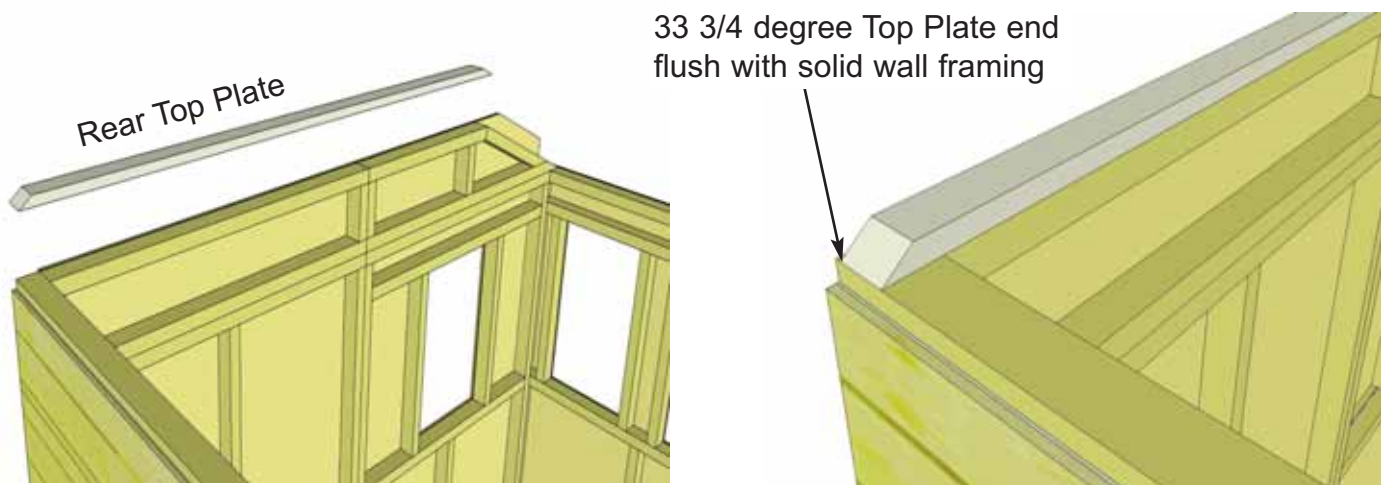

**26.** Locate **Rear Top Plate** (3/4" x 2 1/2" x 73 3/4") and position on wall flush to inside wall framing. Align so angle cut on 33 3/4 degree end is facing the solid wall side and 22 1/2 degree end is facing double window wall side. **Important:** See **Step 27** for Top Plate Angle alignment.

Top Plates should be flush with inside of wall framing.

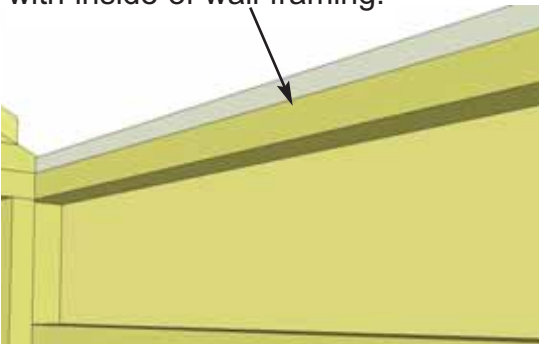

22 1/2 degree angle cut end follows angle of wall.

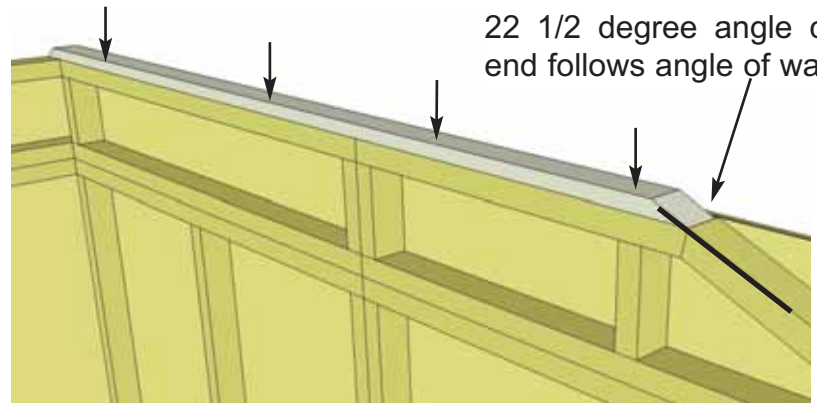

**27.** When properly positioned, attach by screwing down into extendor wall framing with 4 - 2" screws.

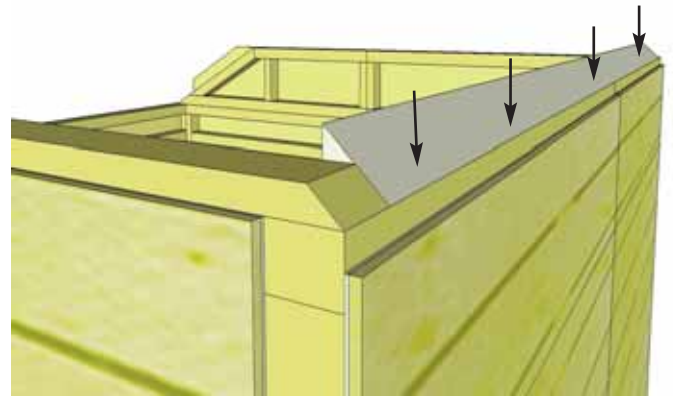
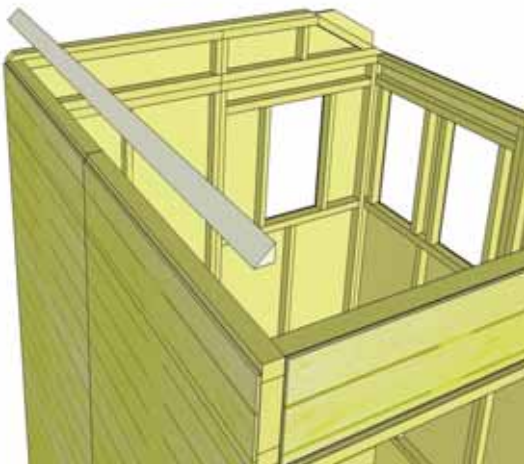

**28.** Next, attach the **Side Top Plate** (1 1/2" x 2 1/4" x 86" 33 3/4 degree cut down outside edge) to high wall side. Position so that angled edge lines up with angle of rear top plate. Secure with 4 - 2 1/2" screws.

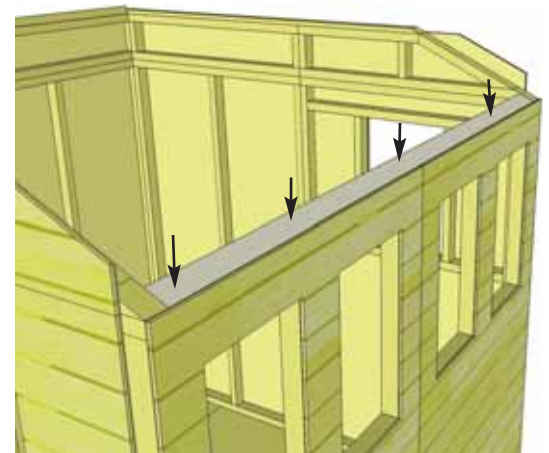
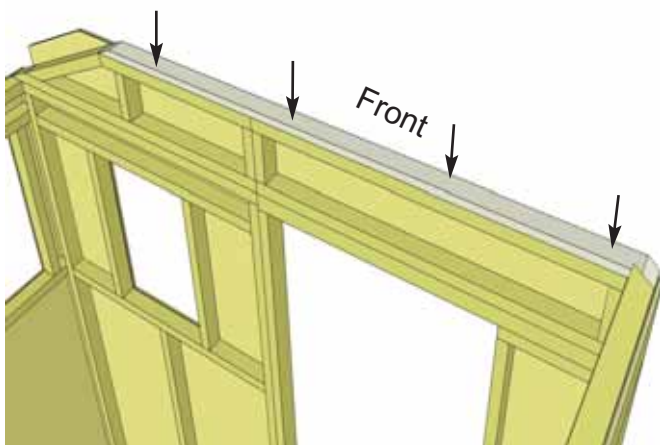

**29.** Position remaining **Front Top Plate** (3/4" x 2 1/2" x 73 3/4") and Window Wall **Side Top Plate** (3/4" x 2 1/4" x 86") into position on wall framing and secure with 4 - 2" screws per piece. Side Top Plate has a 22 1/2 degree cut down 1 edge.

**30.** Attach **Horizontal Wall Extendor Braces** (3/4" x 3 1/2" x 26"/30"/60") to Framing of Extendor and Bottom walls. Start with High Wall Side and attach 60" and 26" long pieces with 10 - 1 1/4" screws. Pieces should be flush with top of Extendor Wall Framing. Alternate screws into both pieces of framing. Complete Front and Rear walls (60" and 30" pieces).

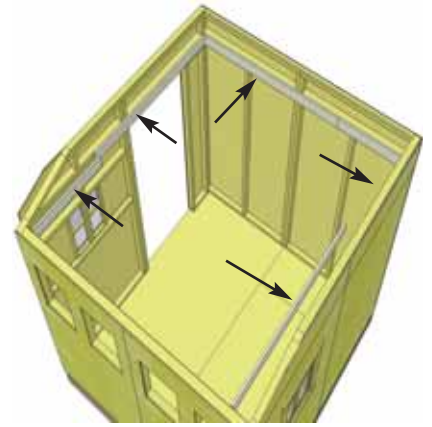

Confirm 32" wide Door Opening prior to attaching walls to floor.

**31.** When all walls are attached together, check alignment with the floor. Bottom wall framing should sit flush with outside floor framing. When positioned correctly, fasten bottom wall plates to floor using 4 - 2 1/2" screws per wall panel. **Important:** If walls are not lining up and appear higher or lower than each other, your floor may not be LEVEL. Please check the level of your floor. You may need to make slight adjustments to level your floor before proceeding.



**Triangular Gable Trim** attached in **Step 63.**



Straight Edge

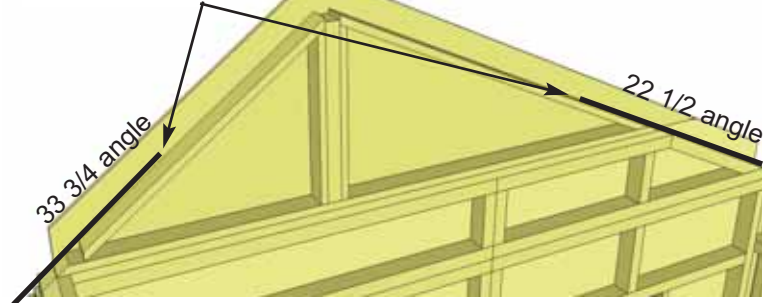

**32.** Lift up **Gable Wall** and place on top of rear wall. Gable side with 33 3/4" degree cut will align with solid wall. Slide Gable Wall side to side and use a straight edge to line up angled framing of gable with Top Plates and Wall. There is some tolerance, try for best fit on both sides.

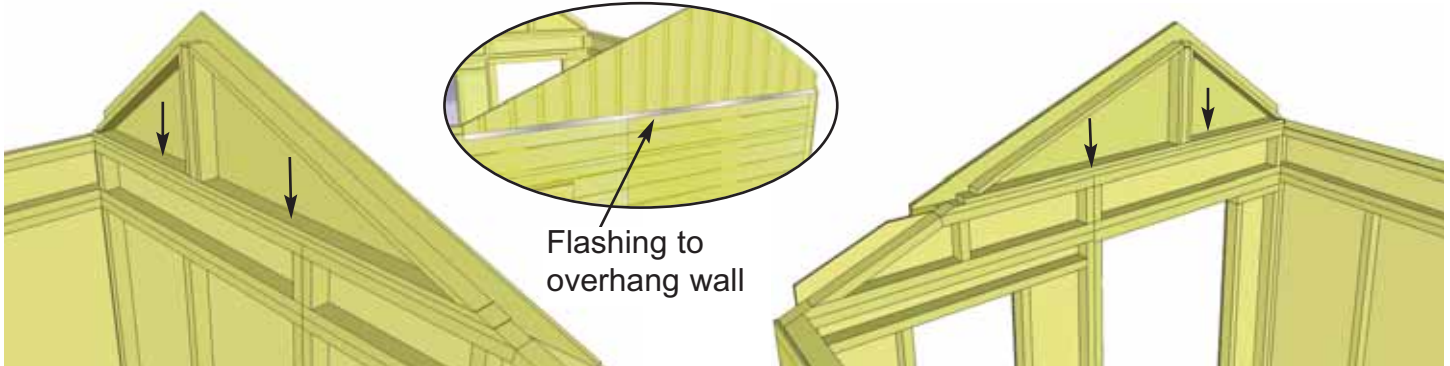

**33.** When Gable wall is positioned correctly, tack in place with 2 - 2" screws. Adjustment to Gable may be required in **Step 42.** Complete other Gable Wall.

# C. Rafter Section

## Long Roof Side

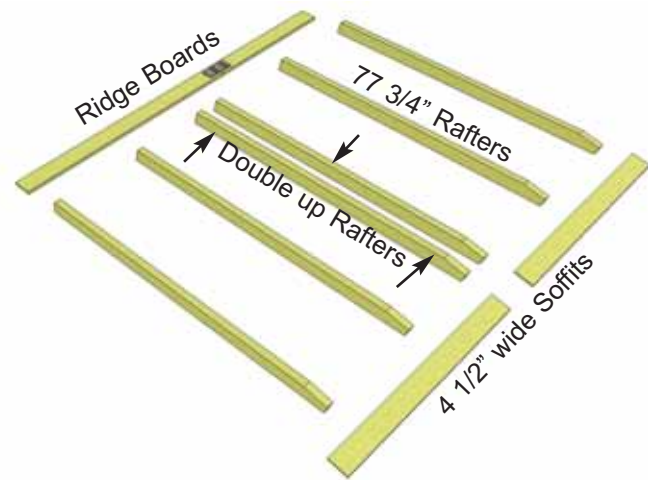
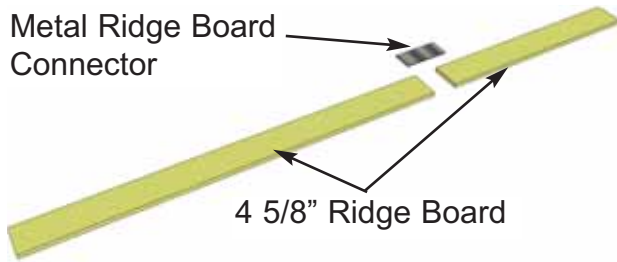

**34.** Starting with **LONG ROOF SIDE**, locate 2 **Ridge Boards** (3/4" x 4 5/8" x 33 1/2" and 3/4" x 4 5/8" x 57 1/2"). Attach together with **Metal Ridge Board Connector** using 8 - 3/4" screws. Locate 6 - 1 1/2" x 3 1/2" x 77 3/4" **Rafters** and 2 - 1/2" x 4 1/2" x 45 1/2" **Soffits** and lay out on a flat level surface as pictured. Screw doubled up rafters together with 3 - 2 1/2" screws. **Note: Soffits for long roof side are 4 1/2" wide, short roof side are 3 1/2"**.

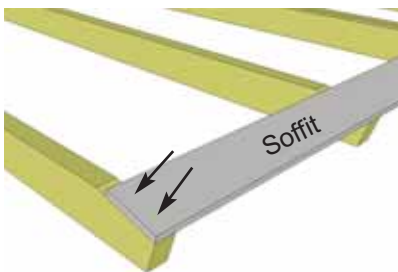

**Important:** Pilot Hole Ridge Board and Soffit to prevent splitting!

**Important:** Ridge Board must be aligned to bottom of rafter end in this position.

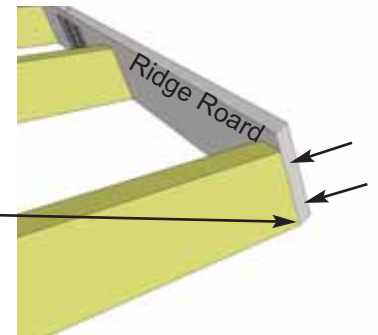

**35.** Attach end of a 45 1/2" long Soffit Board flush to ends of outside rafter with 2 - 1 1/4" screws per rafter end. Drill pilot hole in Soffit to prevent splitting. Attach Ridge Board to opposite rafter end, aligning to bottom of rafter, with 2 - 1 1/4" screws. Center Soffit on Middle Rafter and secure with 2 - 1 1/4" screws. Measure 45 1/2" from outside rafter and secure Ridge Board to rafter with 2 - 1 1/4" screws.

**Important:** Measure 20 1/2" spacing accurately to accommodate Lexan Panels in **Step 56**.

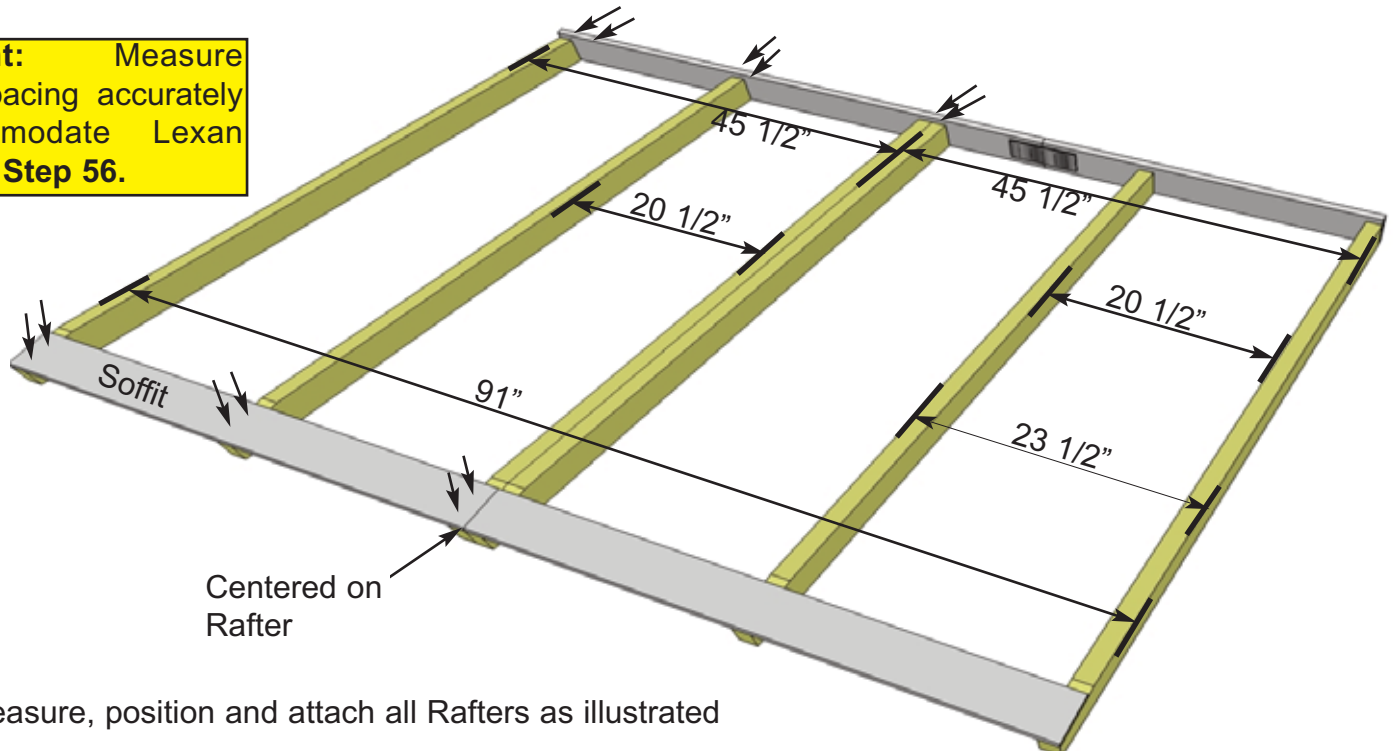

**36.** Measure, position and attach all Rafters as illustrated

## Short Roof Side

**37.** Complete **Short Roof Side Rafter Section** as per **Steps 34 - 36** with the following exceptions:

Rafters length = **37 3/4" long**

Soffit width = **3 1/2" wide**

Ridge Board = **5 1/8" wide**

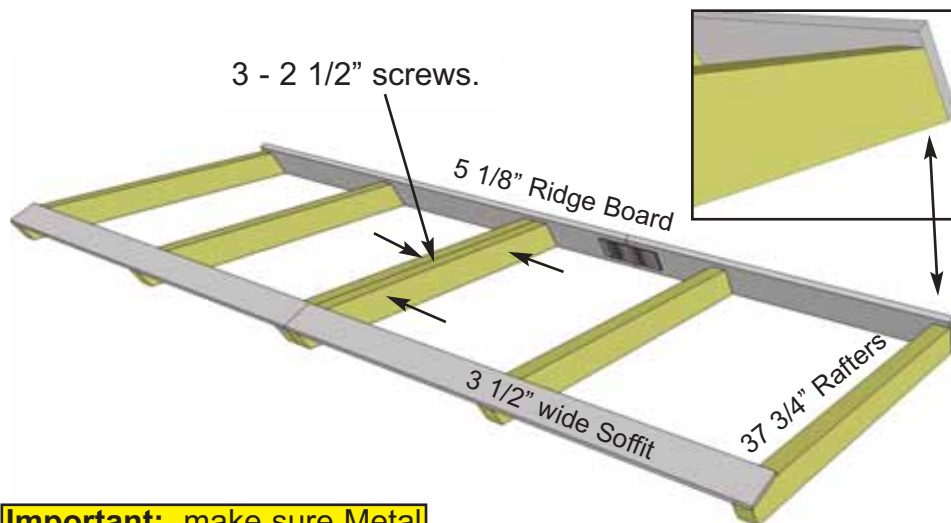

**Important:** make sure Metal Ridge Board Connectors on Long Roof side and Short Roof side are offset. See **Diagram Step 41.**

Slide Bottom of Ridge Board into notch of gable.

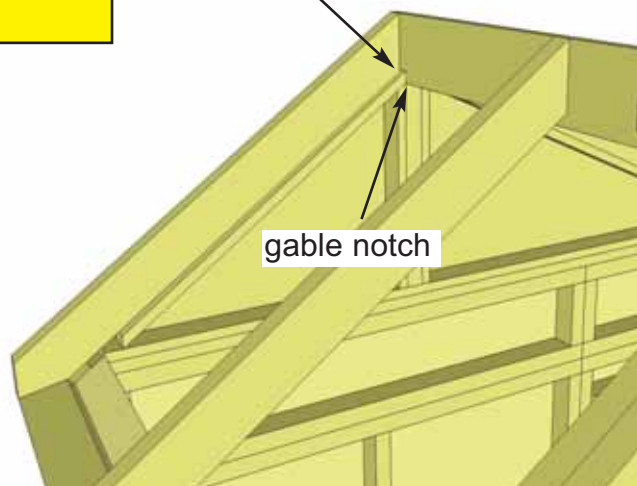
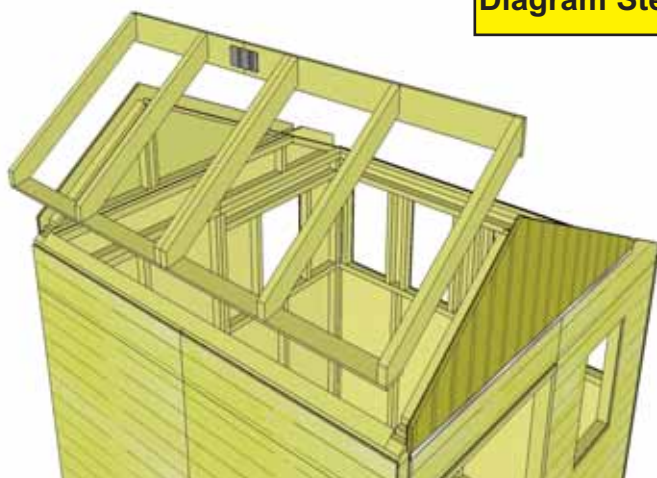

**38.** Starting with the Short Roof Side, lift and flip completed Rafter section over with Soffit now facing down. Slide rafter up on gable framing until bottom of Ridge Board slips into gable notch. Position rafters so they sit evenly on Gable framing from side to side.

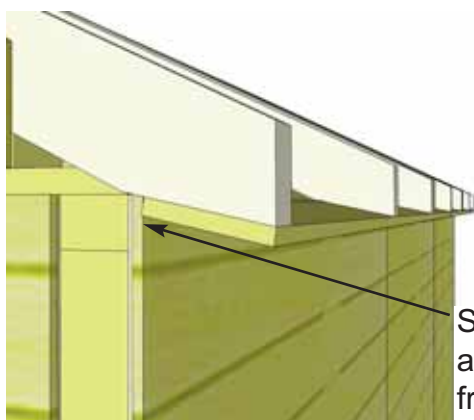

Soffit should sit approx. 1/8" away from wall panel.

**39.** Where Wall and Soffit meet, a small gap may appear. Confirm all Rafters are resting on Top Plate.

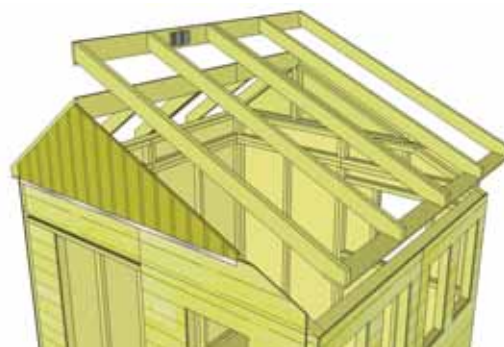

**40.** Lift and flip Long Rafter Side up and place on Gable framing. **Make sure Metal Ridge Board Connectors of both Roof Sections are offset. See Diagram Step 41.**

Short Roof side Ridge Board extends 1/2" past.

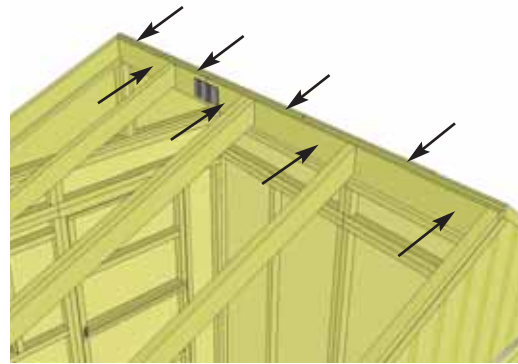
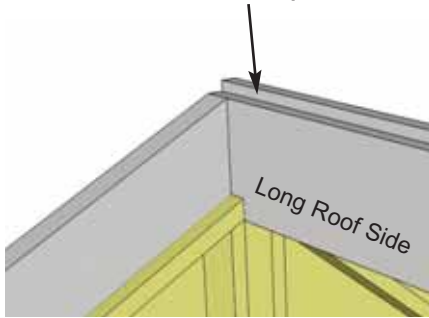

Ridge Board Connectors

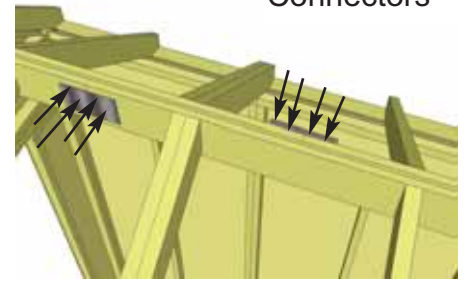

**41.** Slide Long Rafter Section on Gable framing so bottom of ridge board slips into Gable notch. At the peak, align Ridge Boards so they are tight together and secure them with 8 - 1 1/4" screws. **Important:** if there is a gap between Ridge Boards, have two helpers push side walls closer together from outside. To completely secure Ridge Boards, place 4 - 1 1/4" screws into any of the remaining Metal Ridge Board Connector's holes.

**Important:** If Gable framing does not line up with Rafters, remove temporary 2" screws from gable framing (**Step 33**). Re-align gable and secure with 7 - 2" screws into top plate.

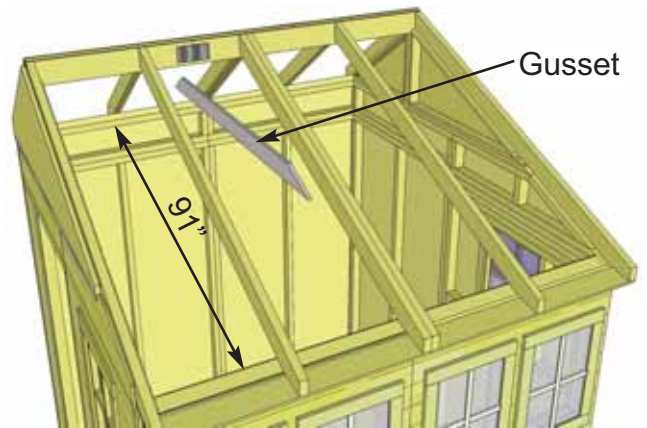
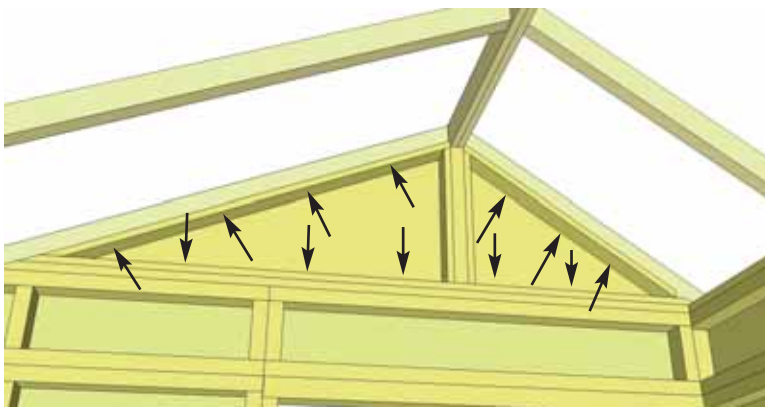

**42.** With both Short and Long Roof Side Rafters in correct alignment, secure Gable framing to both outside rafters with 7 - 2" screws per side at top and with 5 additional 2" screws into wall top plates at bottom. Prior to attaching **Gussets** (3 @ 3/4" x 3 1/2" x 72"), make sure walls are aligned correctly. Have two helpers push on side walls from the outside until the distance between the inside of the top plates is 91".

Leave 1" gap from top of rafter

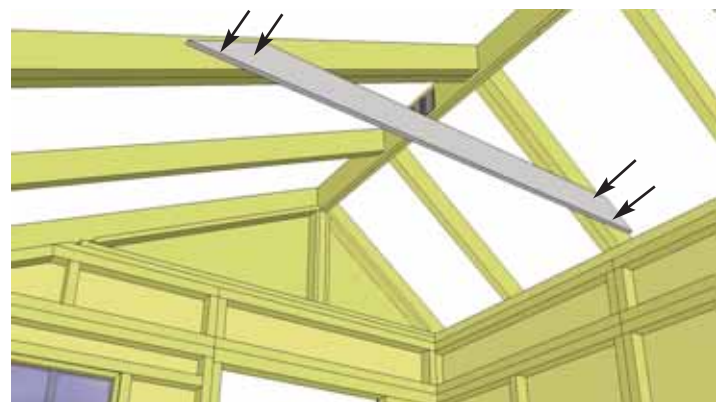
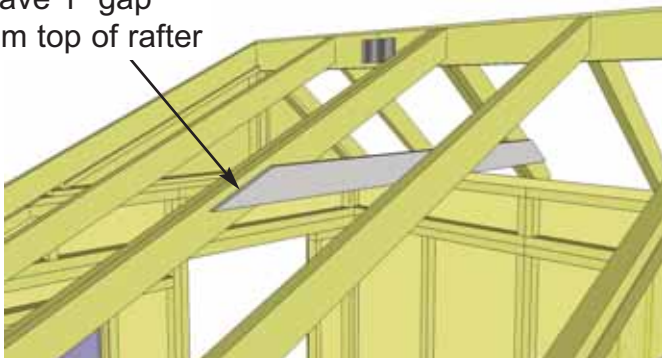

**43.** With walls correctly positioned, attach Gusset to Rafter with 4 - 2" screws. Use a level to check that it is square.



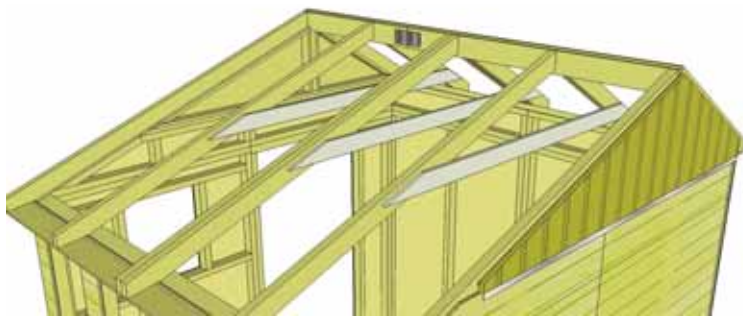

**44.** Complete installation of remaining Gussets.

**Important:** Drill pilot holes to prevent splitting!

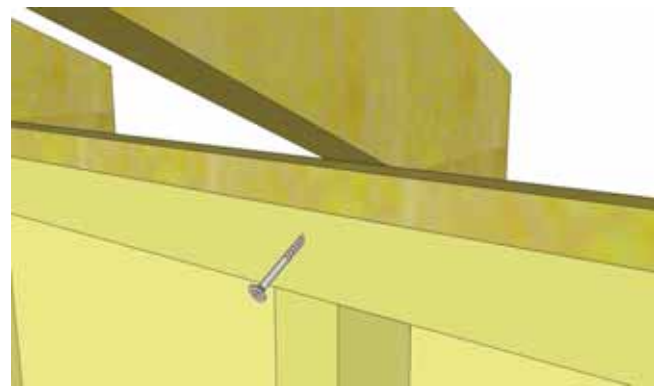
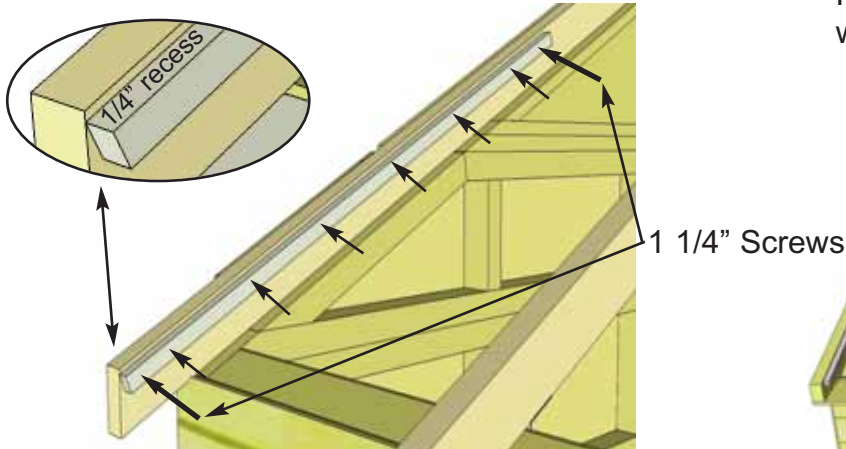

**45.** Secure Rafters to Top Wall Framing with one 3" screw per rafter. Screw through Wall Frame at an angle. Prior to attaching, make sure walls are properly aligned.

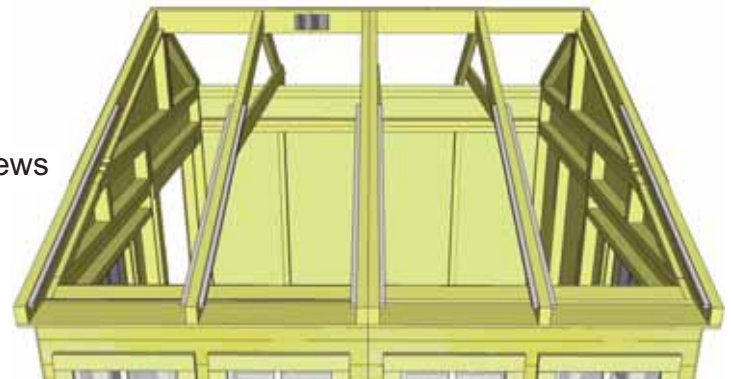

**46.** Position a **Polygal Support Cleat** (3/4" x 3/4" x 44 1/2") on a Long Rafter flush to end and recessed 1/4" down from edge of rafter. Nail to rafter using 6 - 1 1/2" finishing nails. Further secure Cleats with 2 - 1 1/4" screws. **Note:** Start nails in Cleat on ground first. Complete remaining 7 Polygal Support Cleats.

## D. Roof Section

Shingles overhang  
Plywood on outside.

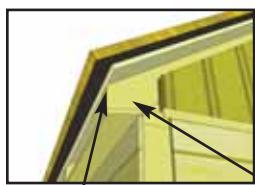

Plywood lines up  
with end of rafter.

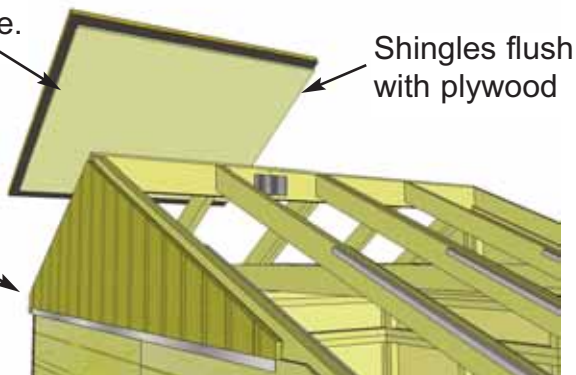

Shingles flush  
with plywood



**47.** Identify all **Roof Panels**. There are 2 Right side and 2 Left side Roof Panels. The outside of the panels will have shingles overhanging the plywood. Starting on the Short Roof Side, lift up and place a roof panel on rafters, centered on mid rafter. End of Plywood on roof should be flush with end of rafter at bottom. Screw down through shingles into rafter with 1 - 2 1/2" screw on bottom row of, for temporary support. **Note:** panel may need adjustments prior to adding additional support in **Steps 51 - 55**.

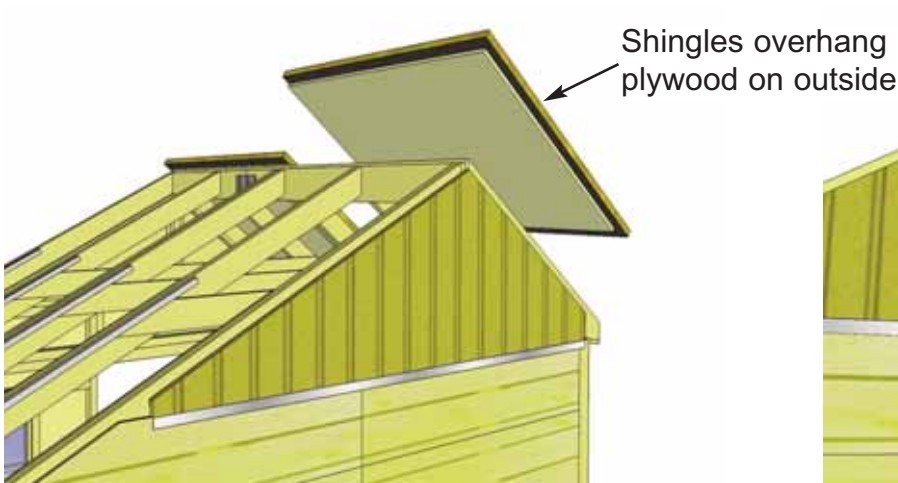

**48.** Lift up and place a 2nd Roof Panel on rafters. Once again, make sure shingles overhang the plywood on the outside of the panel. End of plywood on roof should be flush with end of rafter at bottom.

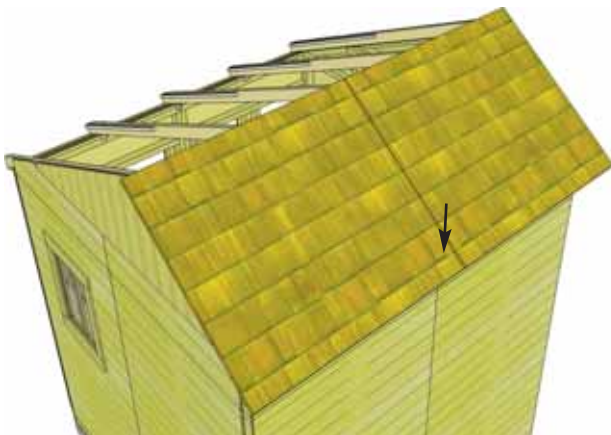

Roof Panel for Long Roof Side.

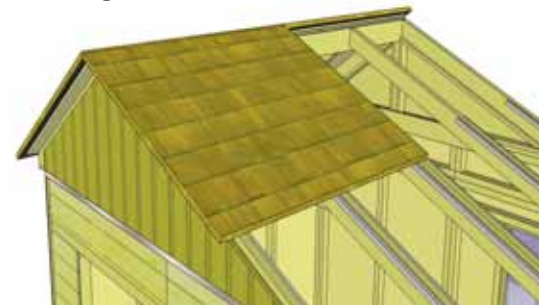

**49.** Both Roof Panels should be centered on Middle Rafters. Screw into bottom row of shingles with 1 - 2 1/2" screw. Lift up Front Roof Panel for long roof side and place on rafters.

Slight Gap between Roof Panels. Long Side will sit slightly past center.

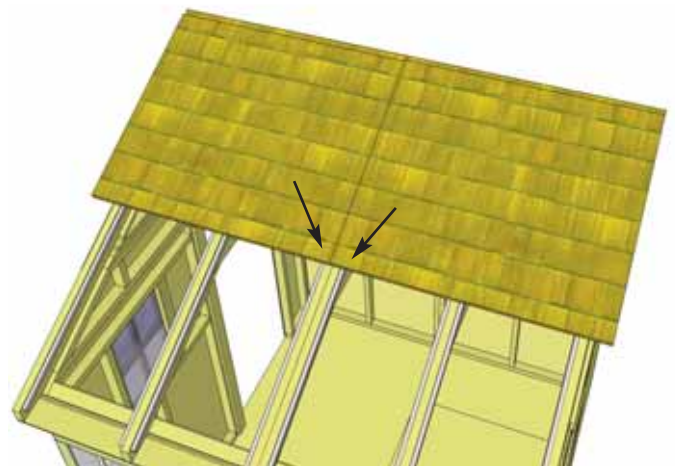

**50.** Follow **Steps 47 - 49** for positioning and attaching Long Roof Side Panels. Reach through skylight opening to attach at bottom. When positioning, align Roof Panels at top so only a small gap between Short and Long Roof Panels exists. Do not proceed to next step until roof panels are aligned properly.



**51.** Install **Filler Shingles** to hide roof seams. There are 2 - Long shingles and 1 Short shingle per seam. Starting at bottom on Short Roof Side, push a Long Filler Shingle underneath shingles directly above it until end is flush with bottom of shingles.

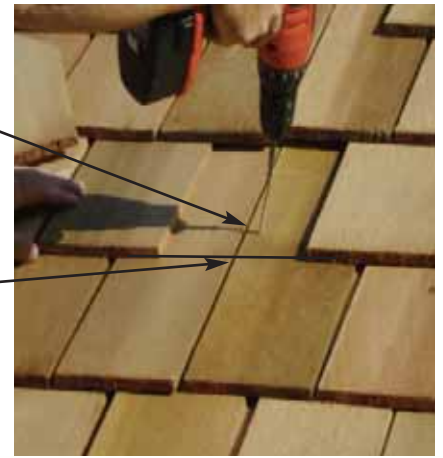

**52.** Screw first filler shingle down to rafters using 1 - 2 1/2" screw per panel (2 in total). Attach above the exposure line and make sure to screw into both rafters.



**53.** Slide in the next Long Filler shingle and attach as per **Step 52**. For the top row, use the smaller shingle to fit. Attach final shingle to roof with 2 shingle nails. Complete Long Roof Side next.

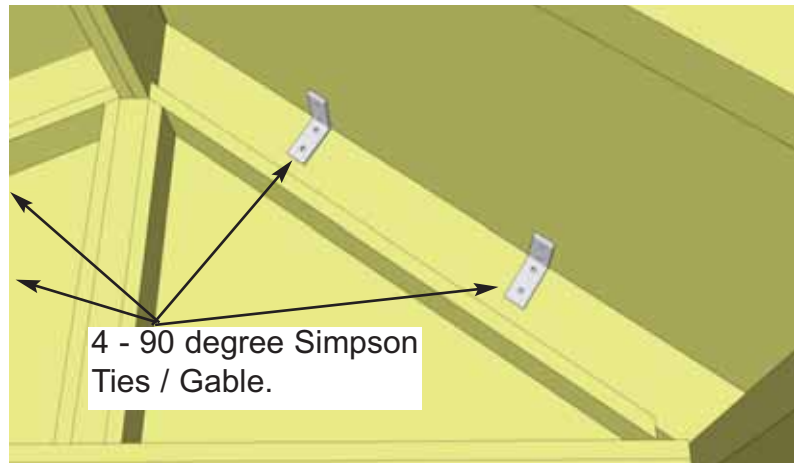

**54.** Position Simpson Strong ties on plywood and outside rafters and secure with 4 - 1 1/4" screws each. There are 4 ties per side.

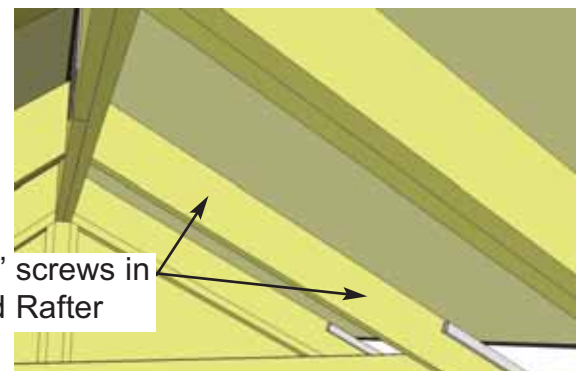
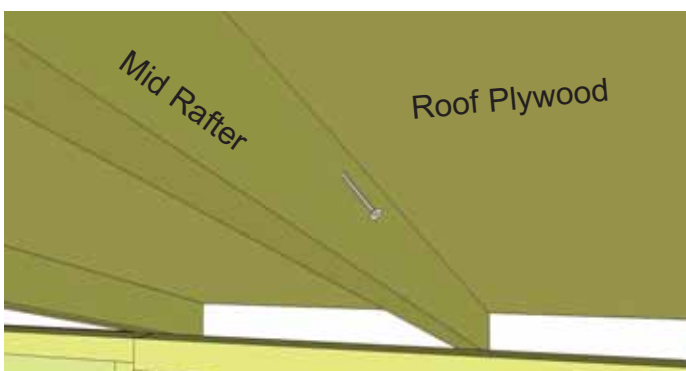

**55.** To further secure roof panels, from the inside, drill pilot holes in each Mid Rafter (2 per Rafter) on an angle. Using 2 - 2 1/2" screws, secure rafters to roof plywood. **Note:** from outside, have a helper push roof panel down so plywood sits flush against rafter when securing.

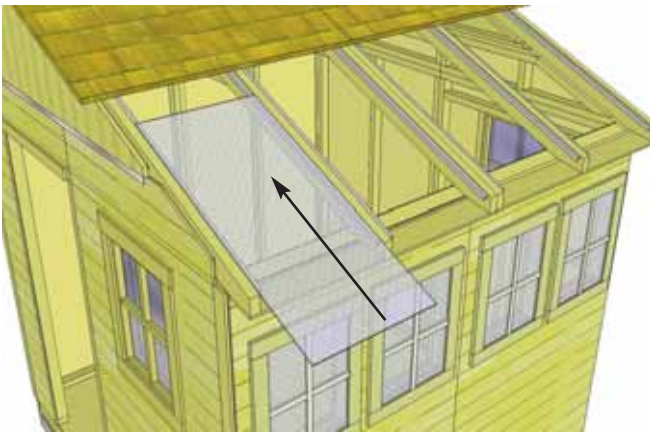

**56.** Installation of 4 **Polygal Panels** is next. Start by removing protective plastic layer from each panel. Exterior/interior side of protective polygal film is printed on film, be sure to note the side and install accordingly. Slide panel up between rafters so it rests on Polygal Support Cleats.

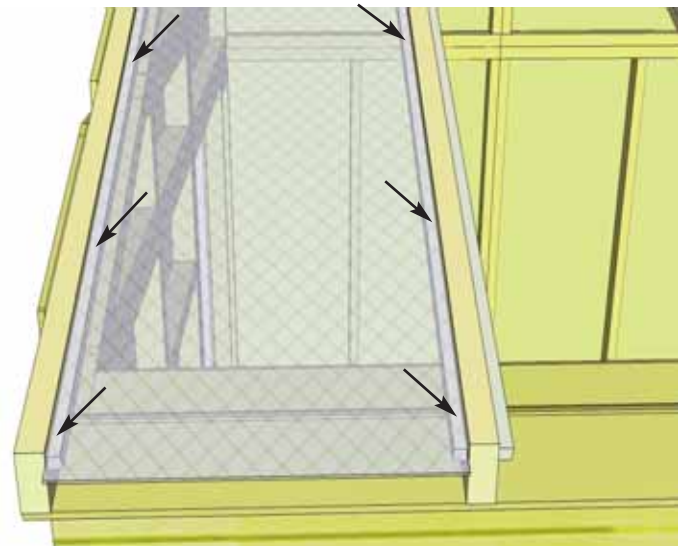

**57.** From the inside, carefully slide end of Lexan underneath roof. Position Polygal Panel equally between rafters and overhanging end of rafter by 1". With 6 - 1 1/2" finishing nails, secure panel to Polygal Support Cleats.

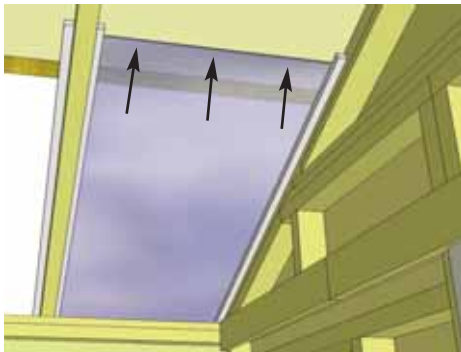

**58.** Use 3 - 1 1/2" finishing nails to secure Polygal Panel to underside of roof plywood.

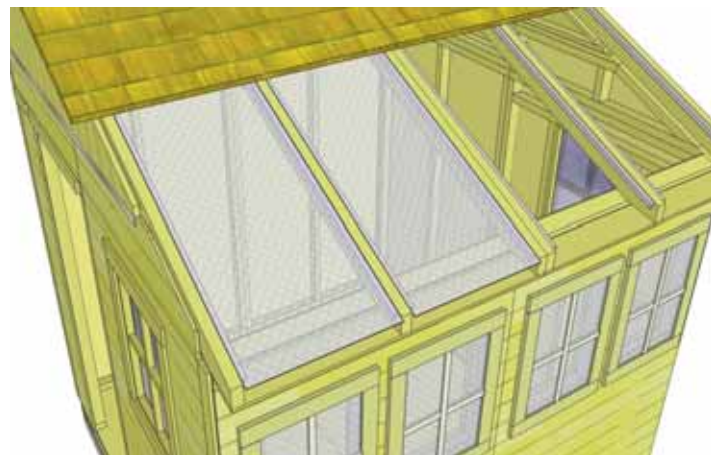

**59.** Position and secure 2nd Polygal Panel as per **Steps 56-58**.

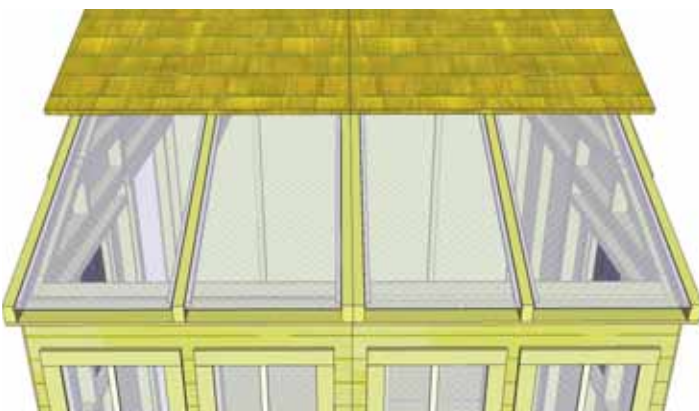

**60.** Complete installation of remaining Polygal Panels.

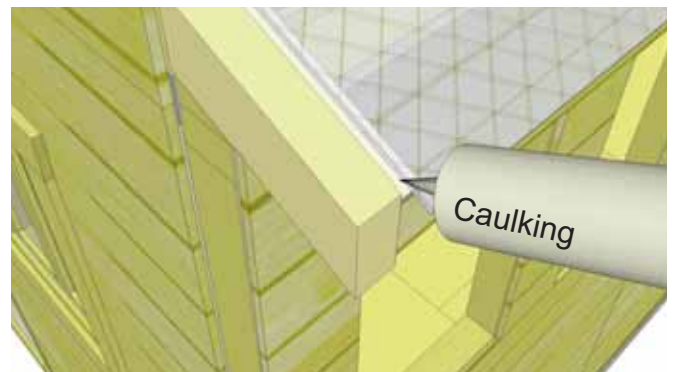

**61.** With a Caulking Gun, apply **Silicon** to seal gaps between rafters and Polygal Panels. Apply Silicon down each side of rafter. Use liberal amounts to properly seal.

## E. Miscellaneous Section

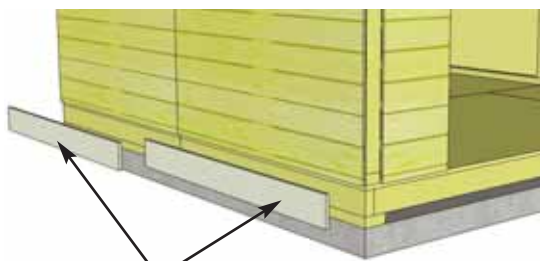

2 pieces of Bottom Skirting per side

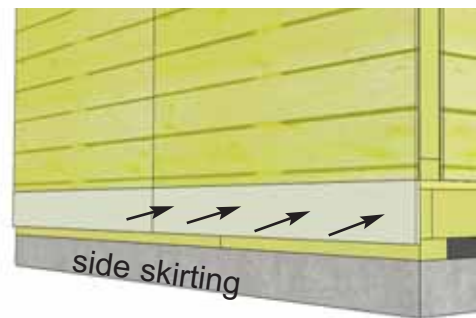

side skirting

**62.** Attach **Bottom Skirting** (8 @ 1/2" x 4 1/2" x 45 1/4") around the base of the shed. Skirting will hide floor framing. Gaps in corners will be covered by Wide Trim pieces later. Start with side pieces first and attach with 4 - 1 1/2" finishing nails per piece.



Front Skirting

Gap in corner

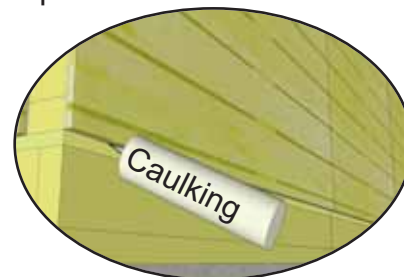

Caulking

**Optional:** Caulking seams will help prevent moisture from entering your shed. Caulking is included to complete Lexan Windows only. Additional Caulking may be required.

**Note:** Triangular Gable Trim is located inside gable corner behind scrap piece marked with "X"

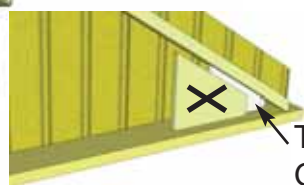
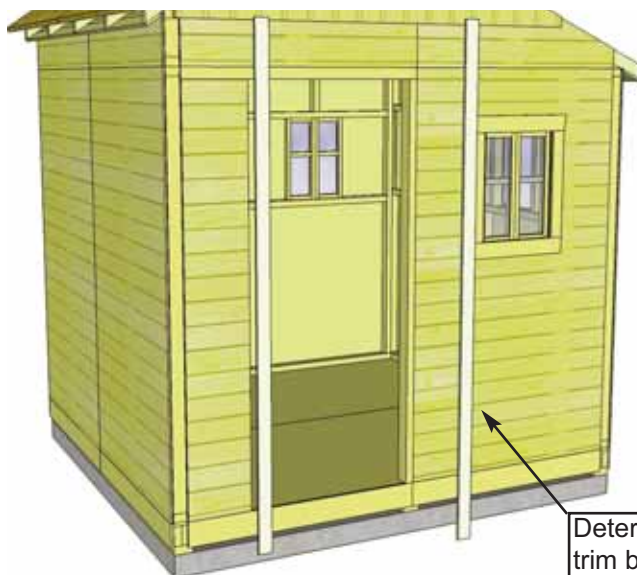

Triangular Gable Trim

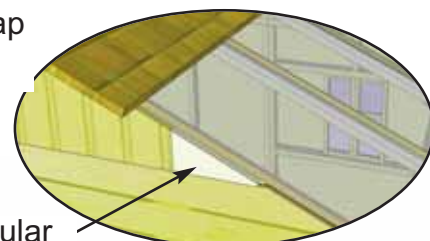

Determine vertical location of trim by using horizontal Gable Trim as a guide. See Step 82.

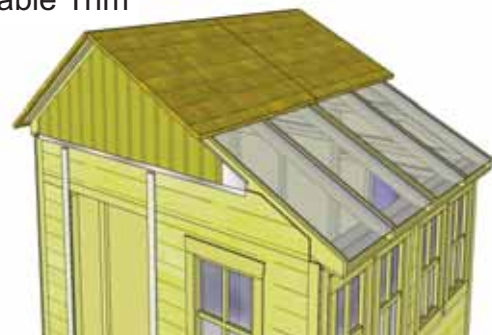

**63.** Position 2 **Door Trims** (2 - 1/2" x 2 1/2" x 87") on each side of door opening. Right side will sit flush with Door Jamb. Left side will sit flush on edge of Narrow wall. Do a dry run with the Horizontal Gable Trim (**Step 82**) to determine vertical height of Trims. Attach with 8 - 1 1/2" finishing nails each. Position **Triangular Gable Trim** over exposed cavity of Gable Wall on Long Roof Side. Use 2 finishing nails to secure into rafter. Complete for both front and rear.

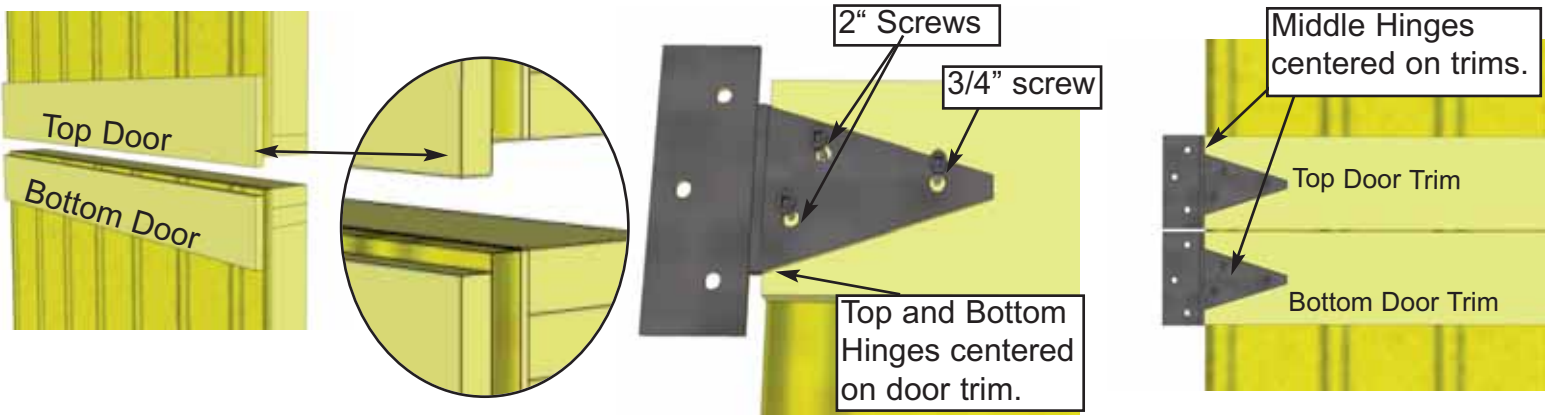

**64.** Attach Door Hinges to **Top** and **Bottom Dutch Door** sections. Top Door has trim overhanging door at bottom while bottom door has trim recessed slightly. Hinges should be centered on door trim with barrel nudged to end of trim. Use 2" & 3/4" black headed screws as shown above.

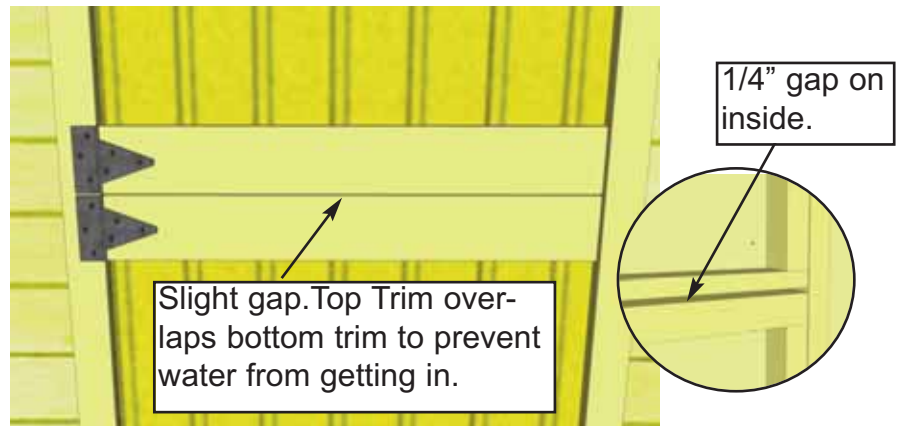
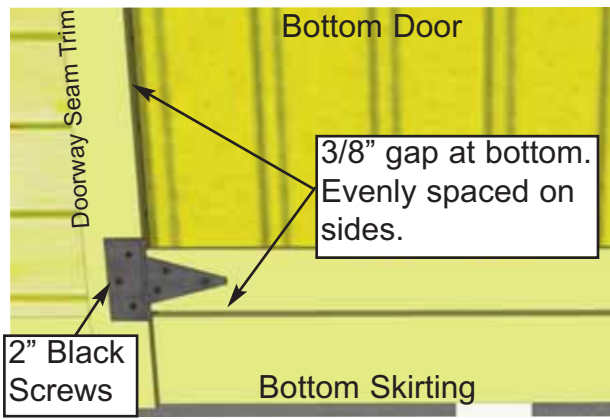

**65.** Place Bottom Dutch Door panel into position. Gap 3/8" on bottom, evenly space on sides, and attach hinge to doorway seam trim with 2" black headed screws. Use shim to help keep the door evenly spaced on bottom. One of the extra roof shingles (see parts list) can be used.

**66.** Place the Top Dutch Door Panel into place and gap top and bottom trims on the outside about 1/8" apart. On the inside, horizontal door frames should be about 1/4" apart. Use a shim once again to help you. Attach hinges to trim with 2" black headed screws provided.



Temporarily positioned Interior Door Stop to help align Interior Barrel Bolt.

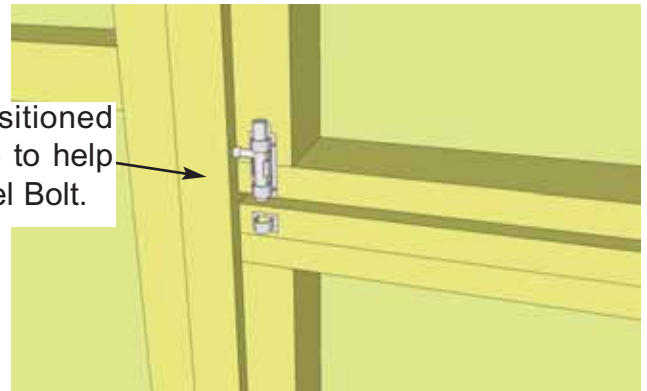

**67.** Attach **Door Handle**, **Exterior Barrel Bolt** and **Interior Barrel Bolt** to door. Handle is positioned on top door, Barrel Bolt on bottom door and Interior Barrel Bolt (silver) to top door stud. Attach Black Barrel Bolt as illustrated above with 3/4" Black Screws. Note how female part of Barrel Bolt is positioned higher than male. Do a dry run first to position Barrel Bolt correctly. **Important:** Drill pilot holes with 1/8" drill bit prior to securing with screws to prevent wood splitting.

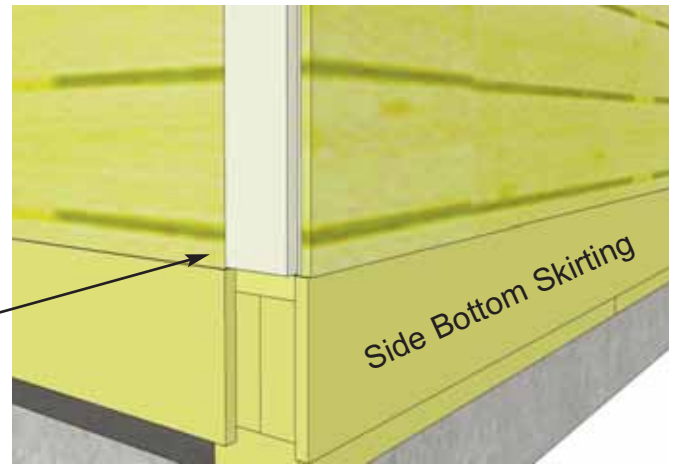

**68.** Attach **Filler Trim - Tall and Short** (2 - 1/2" x 2 1/2" x 75" & 2 - 84") to front and rear walls in each corner with 6 - 1 1/2" finishing nails. Strips are positioned flush with siding and bottom skirting.

**69.** Align and attach **Narrow Trims** in each corner. There are 2 Short Wall Trims (1/2" x 2 1/2" x 79"), and 2 Tall Wall Trims (1/2" x 2 1/2" x 88"). Align Trim tight underneath Soffit. Position flush with Filler Trim so Wide Trim will cap it when attached in **Step 70**. Use 8 - 1 1/2" finishing nails to secure each piece. Note that Narrow Trim will sit slightly below Bottom Skirting when correctly attached.

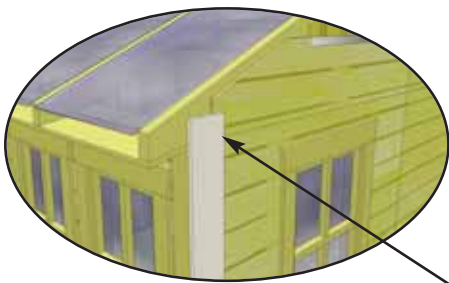

**70.** Position **Wide Trims** in each corner. There are 2 Short Wall Trims (1/2" x 4 1/2" x 82"), and 2 Tall Wall Trims (1/2" x 4 1/2" x 87"). Align to cover Filler Trim and cap Narrow Trim. Wide Trim will be flush with Narrow Trim at bottom. Secure trim with 8 - 1 1/2" finishing nails. Complete remaining corner trims.

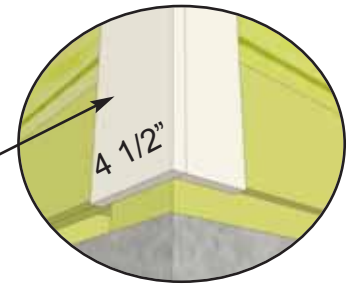
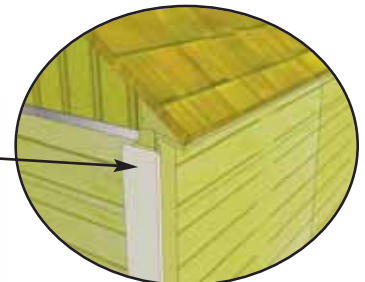



**71.** Attach remaining **Narrow Wall Trims** around the Sunshed. Narrow trims are used where wall panels come together and leave a seam. **Note:** the Narrow Trim on the Short Wall side is only 79" long. Attach with 8 - 1 1/2" finishing nails per piece. Align Trim flush at bottom with corner trim.

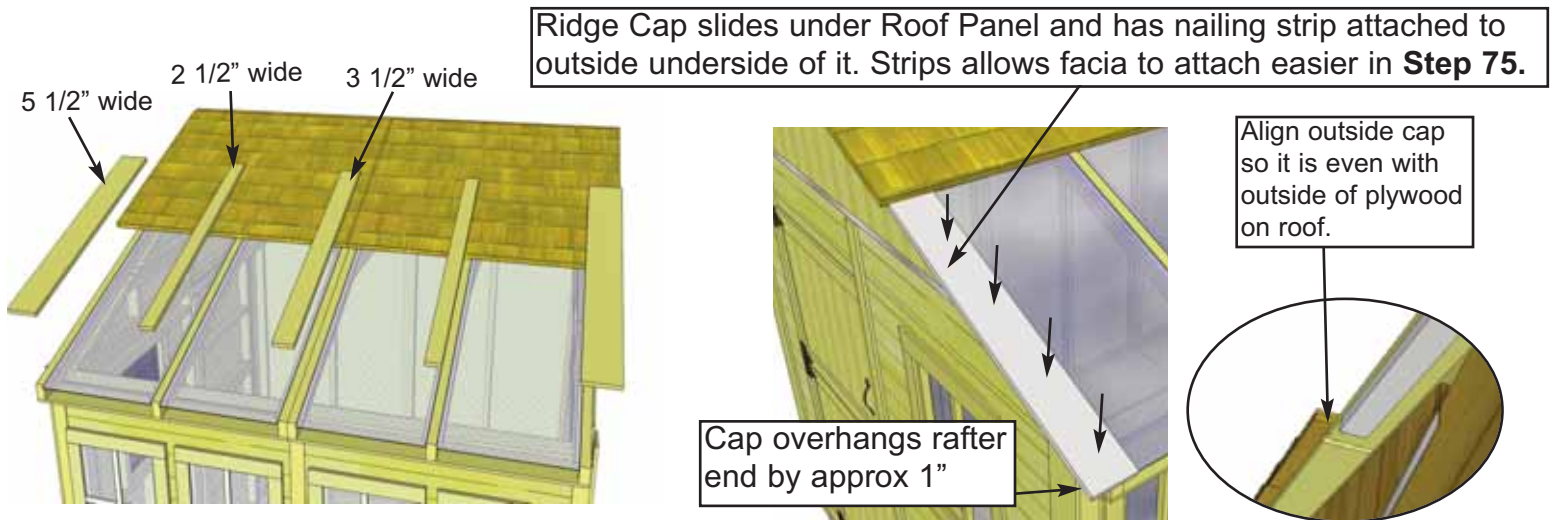

**72.** Locate all **Ridge Caps** for Polygal Panels (41 1/2" long - 2 Outside / 2 Mid / 1 Center). Starting from the outside, position a 5 1/2" wide cap so outside edge is aligned with plywood of roof and Cap end slides under roof until in contact with plywood. When correctly aligned, attach Cap to center of outside rafter with 6 - finishing nails. **See below for diagram of alignment.** Outside Ridge Cap has nailing strip attached.

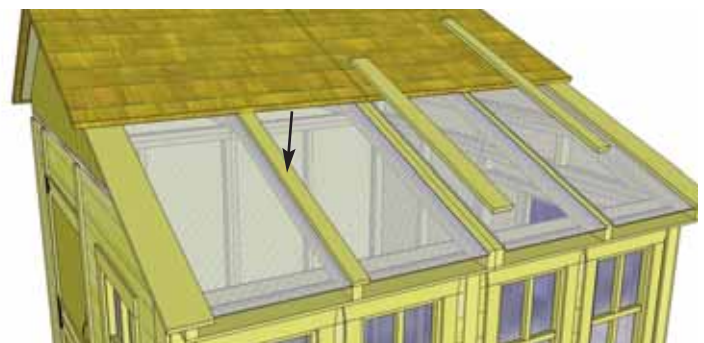

**73.** Position Mid Ridge Caps evenly spaced on mid rafters. Attach as per **Step 72.**



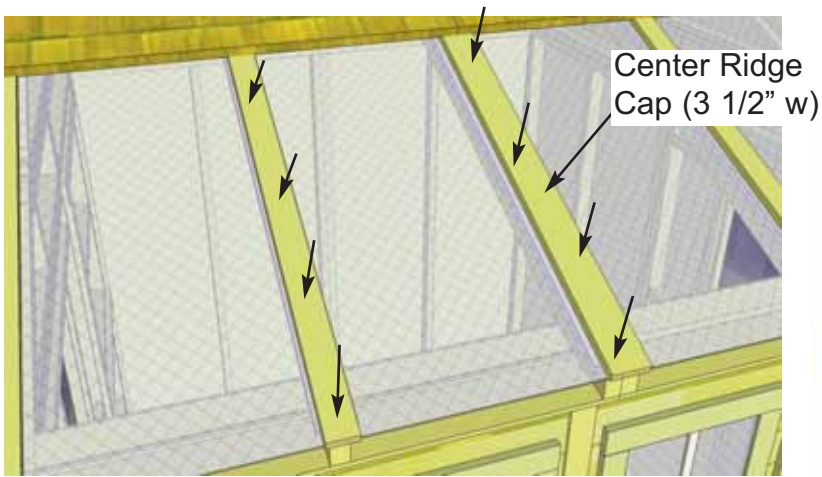

**74.** Align and attach remaining Ridge Caps as per **Steps 72 & 73**.

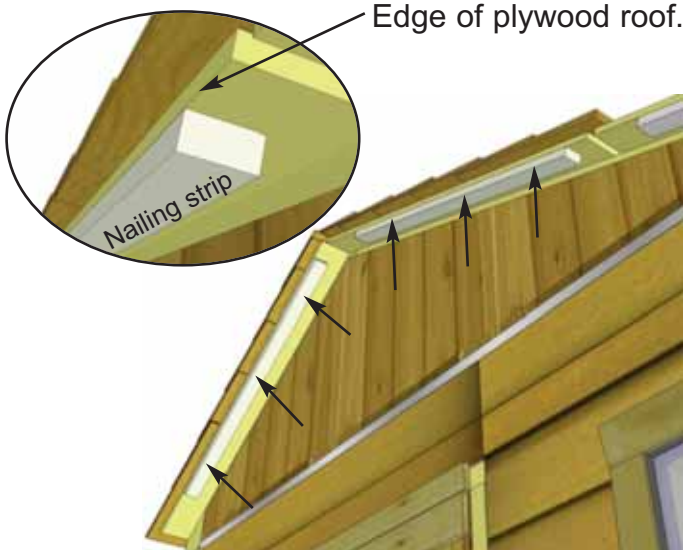

Do a dry run with Front and Rear and Side Facia (Steps 75-77) to confirm correct positioning prior to attaching.



**75.** Attach **Facia Nailing Strips** (3/4" x 1 1/2" x 30") to the outside of plywood roof sheathing using 3- 1 1/4" screws per piece. Do all outside roof panels. Starting with the **Short Roof** side, attach **Front and Rear Facia** (3/4" x 3 1/2" x 38 1/4" angle cut on ends) to end of roof plywood with 5 - 1 1/2" finishing nails per side. Facia end lines up with rafter ends. Do a dry run with side facia in **Step 76** before attaching.

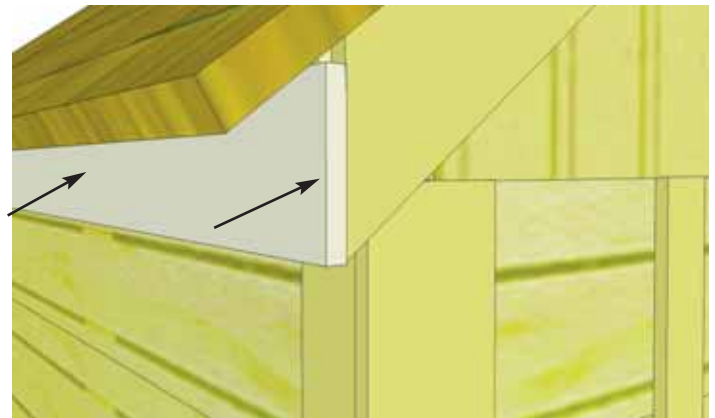

**76.** Attach **Side Facia** (4 @ 3/4" x 3 1/2" x 49") to roof rafter ends. There are 2 Side Facia pieces per side. Secure with 8 - 1 1/2" finishing nails per piece. Side Facia will overlap Front and Rear Facia.

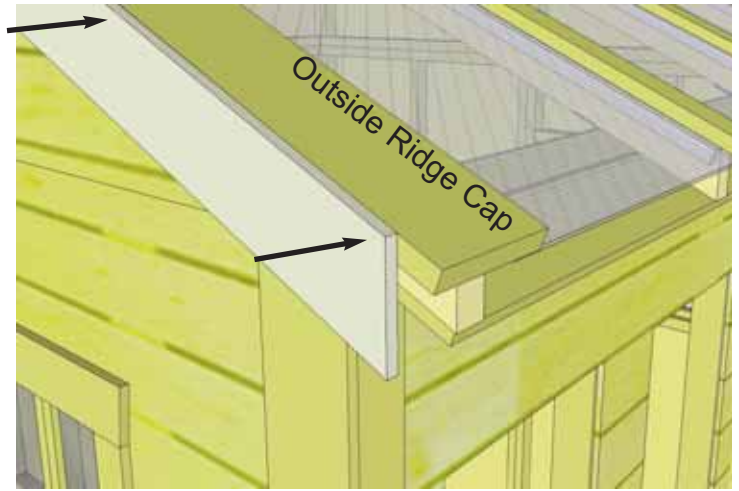
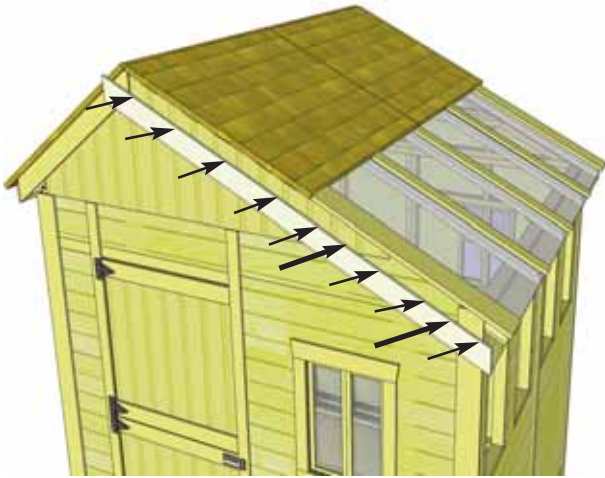

**77.** Attach Long **Front and Rear Fascia** (3/4" x 3 1/2" x 78 3/4" angle cut on ends) to roof plywood ends and Outside Ridge Cap edge with both 1 1/2" finishing nails and 1 1/4" screws. Use 2 screws where Outside Ridge Cap and Fascia meet. Line Fascia up so it is even with rafter ends.

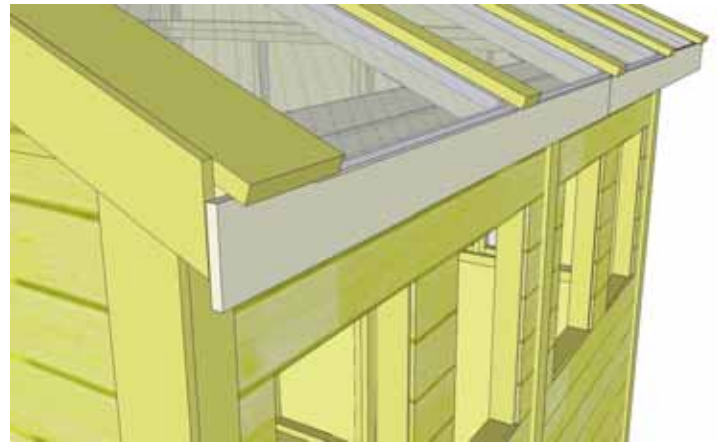
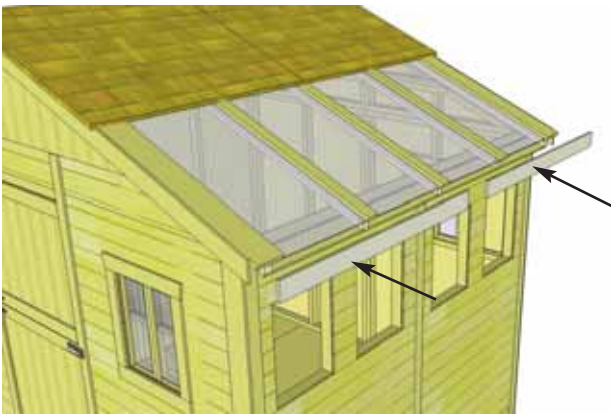

**78.** Attach remaining **Side Fascia** to roof rafter ends as per **Step 76**.

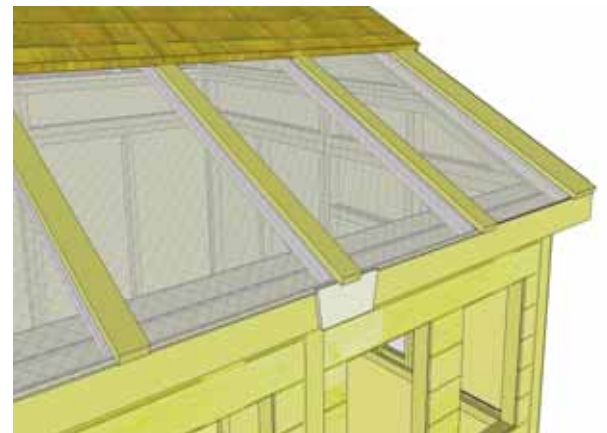
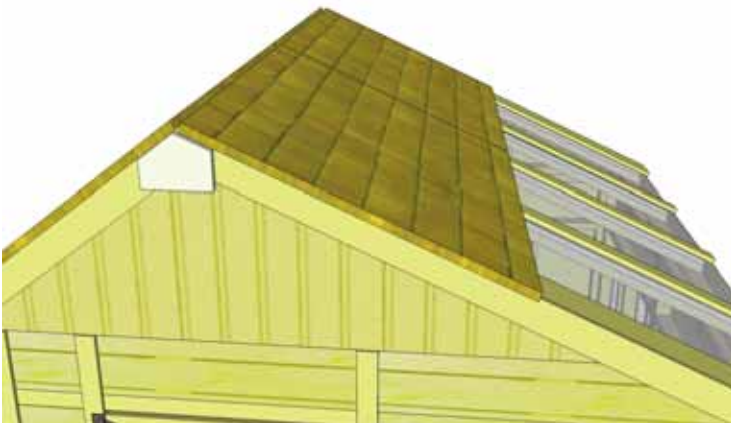

**79.** Attach **Fascia/Trim Detail Plates** and **Pentagon Detail Plates** to cover seams where fascia trim pieces come together. Secure each with 4 - 1 1/2" finishing nails.

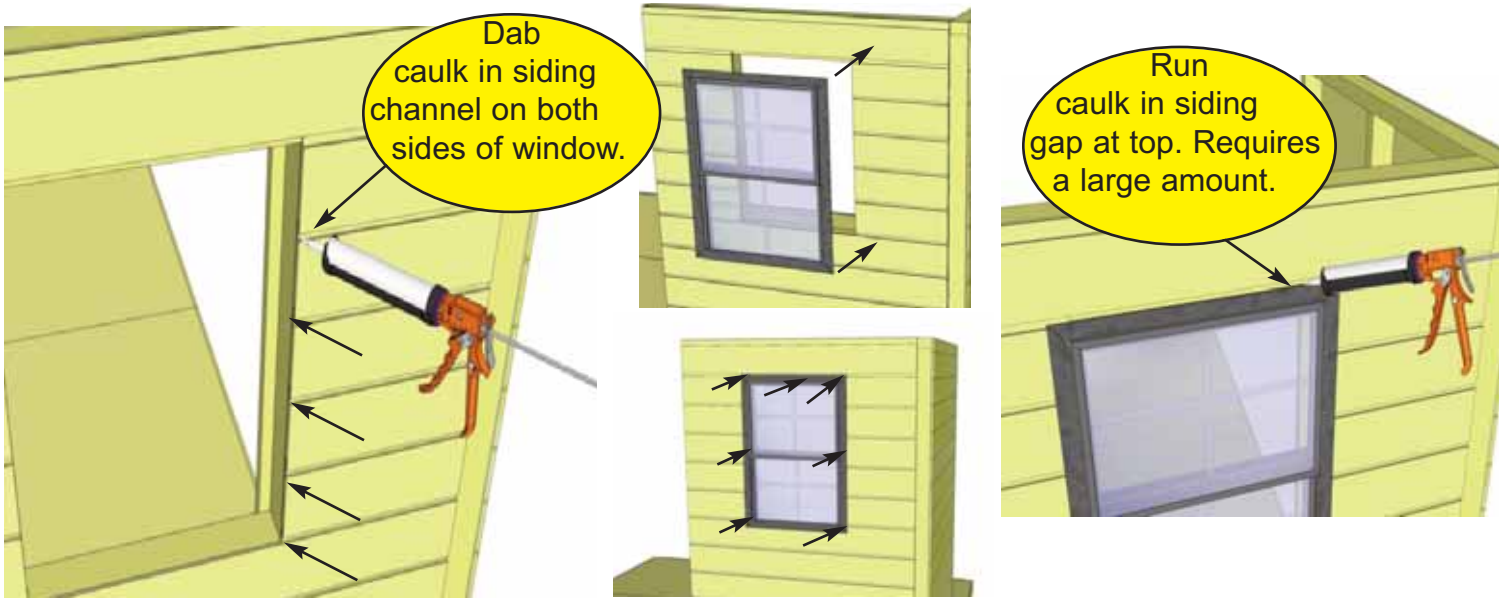

Dab caulk in siding channel on both sides of window.

Run caulk in siding gap at top. Requires a large amount.

**80.** Locate **Window Inserts for Regular Window Walls**. Before installing, dab caulk in siding channel on both sides of window opening. This will prevent water from getting in behind window. Position window in cavity and secure with 8 - 1 1/4" screws. Caulk gap between siding and window at top. This requires a large amount of caulking but is important to fill. Later, Window Trims will be installed to hide caulking.

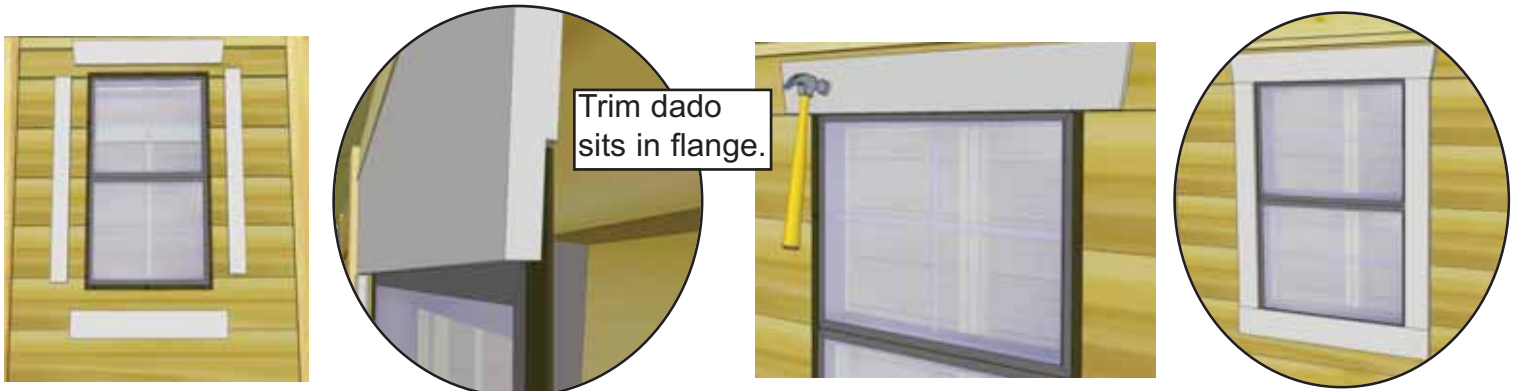

Trim dado sits in flange.

**80a.** Position Window Trim around window doing a dry run first and attach with 4 - 1 1/2" finishing nails per piece. There are two Trim Kits (Regular / Narrow). The regular window kit = 1x 24 1/16" = top (angle cut on ends) / 3 x 23" = Sides & Bottom. Narrow window kit = 1 x 19 7/8" Top, 2 x 21 7/16" Sides, 1 x 18 3/4" Bottom. Window trim has a small dado on reverse face. Outside flange of window will roughly sit in the dado to give a better fit.



**81.** To complete trimming of your shed, attach both the **Horizontal Door Trim** (32") and **Horizontal Narrow Wall Trim** (8 3/4") with 4 and 2 - 1 1/2" finishing nails.



**82.** Attach **Horizontal Gable Trim** (1/2" x 4 1/2" x 85 1/2") to both front and rear of shed. Position equally over gable and wall seam to cover Gable Flashing. Use 8 - 1 1/2" finishing nails per piece to secure.

**83.** Assemble **Flower Box Kit** with Assembly Instructions included. Position completed Flower Box below bottom of window trim and secure with 2 - 2 1/2" screws. Screw from inside of box into the center wall stud. Attach second screw 2" underneath first screw and once again into the wall stud. Install Flower Box Kits underneath each window.

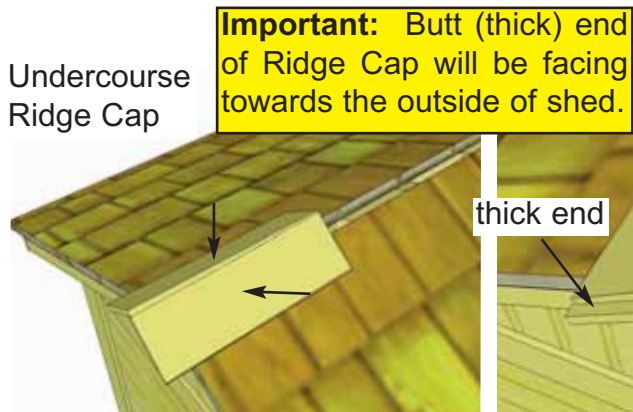

**84.** Place First **Roof Ridge Cap** (Lower Grade Undercourse Ridge Cap) on roof peak overhanging shingles by approximately 1". Attach with 2 - 1 1/2" Shingle Nails 9" from end. Place 2nd Ridge Cap 1" back from 1st cap. Attach with 2 - 1 1/2" Shingle Nails 9" from end.

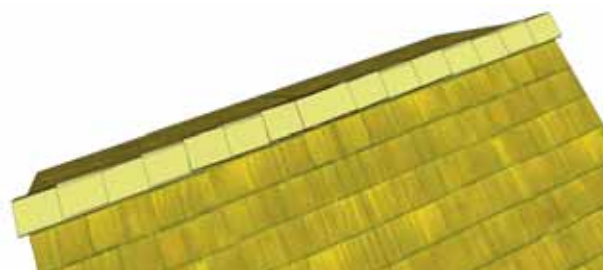
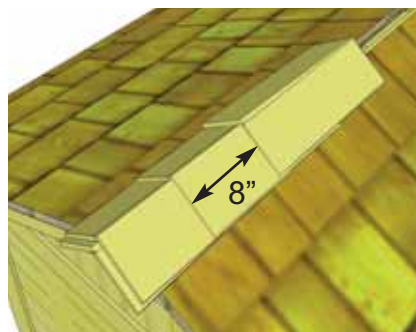
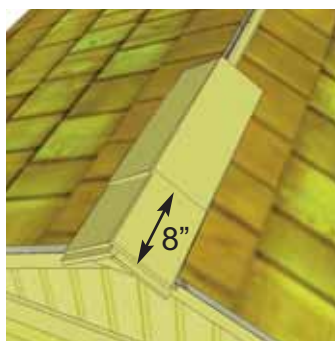

**85.** Place 3rd Ridge Cap 8" back from 2nd (enough to cover shingle nails). Attach 3rd Ridge Cap down as per **Step 84**. Continue to position and attach Ridge Caps until half the roof is complete. From opposite side, position and attach Ridge Caps as described above. Score/cut 1 Ridge Cap to 12" or to fit in the center of roof. Attach center cap with 4 - 1 1/2" Shingle Nails.

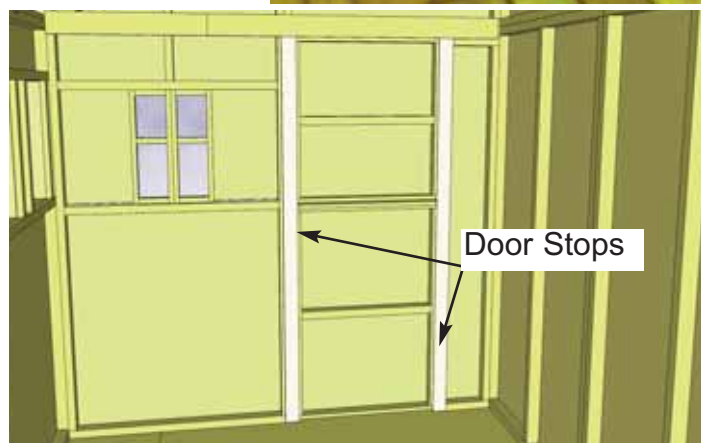
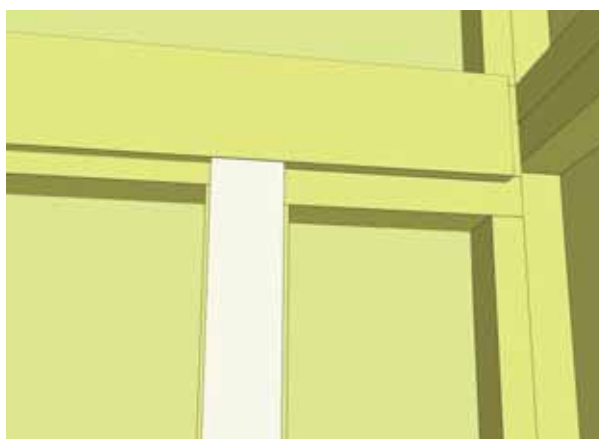
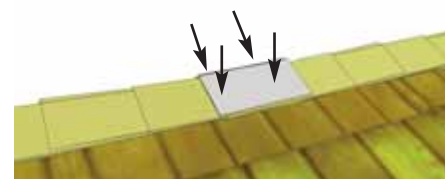

**86.** Attach Interior **Vertical Door Stops** to door framing from inside of shed. Use 4 - 2" screws to secure each Stop. Stops should overlap door by approx. 1/2".

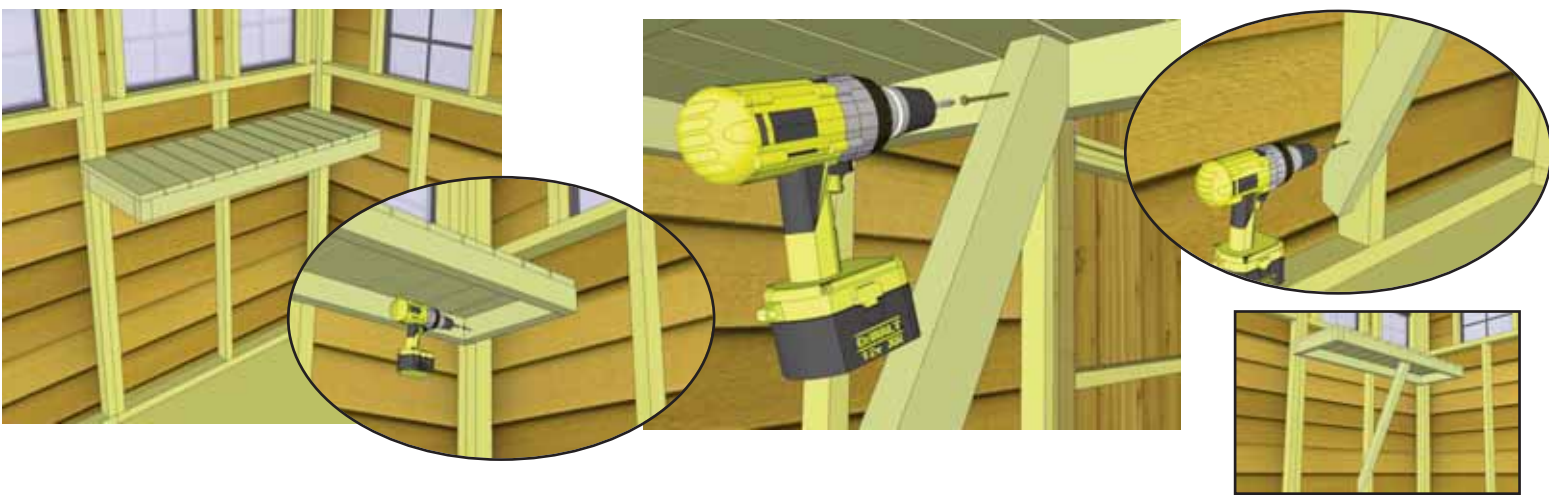

**87.** Locate 1 Long **Potting Shelf** and 1 **Leg**. Position shelf in corner tight against wall framing. While supporting the shelf, attach shelf with 2 1/2" screw. Place leg underneath shelf and attach to inside shelf frame and wall framing as illustrated above with 2 1/2" screws.



**88.** Place Short Potting Shelf against wall framing and end of long shelf framing. Attach with 2 1/2 " screws as per **Step 87**. Use a level to confirm shelving is square and level. Attach leg as previously illustrated. Screw to wall stud and up into the underside of the of shelf framing.

Complete attaching remaining long shelf in corner as per **Steps 87 & 88**.



Completed  
Potting Shelf



## Congratulations on Completing your 8 x 8 Sunshed!

We hope your experience constructing your Garden Shed has been both positive and rewarding.

**Note:** Our Sheds are shipped as an unfinished product. If exposed to the elements, the western red cedar lumber will weather to a silvery-gray color. If you prefer to keep the cedar lumber looking closer to the original color, we suggest that you treat the wood with a good oil base wood stain. You may also wish to paint your new shed rather than stain it. In both cases we recommend that you consult with a paint and stain dealer in your area for their recommendations.



We value your feedback and would like to hear back from you on how well we are doing in the following areas:

1. Customer Service
2. On Time Shipping
3. Motor Freight Delivery
4. Quality of Materials
5. Assembly Manual
6. Overall Satisfaction.

Please call, write or email us at:

Outdoor Living Today

Canadian Address  
9393 287th Street  
Maple Ridge, British Columbia  
Canada V2W 1L1

United States Address  
P.O. Box 96  
Sumas, Washington  
USA 98295



The materials contained in this Assembly Manual may be downloaded or copied provided that **ALL** copies retain the copyright and any other proprietary notices contained on the materials. No material may be modified, edited or taken out of context such that its use creates a false or misleading statement or impression as to the positions, statements or actions.