

WYNDHAM COLLECTION

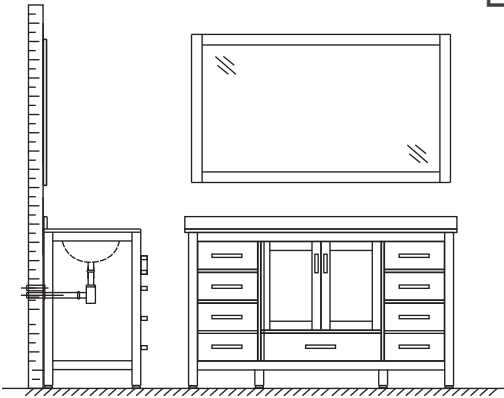

- Prior to installation please check received items against the "Packing List". Please report any missing items to your retailer immediately.
- Protect all surfaces from sharp objects, high heat sources, direct prolonged sunlight and chemical hazards.
- Professional installation recommended.

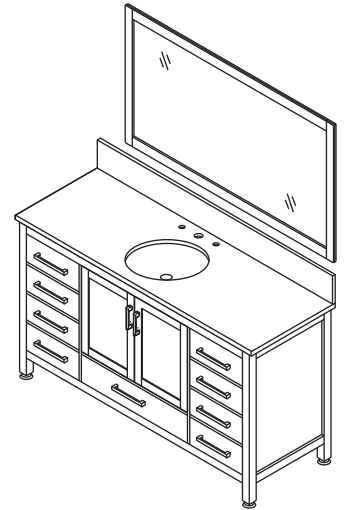

PACKING LIST

(Not all components may be included, depending upon your purchase)

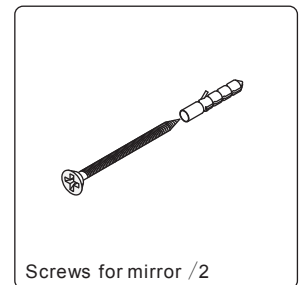
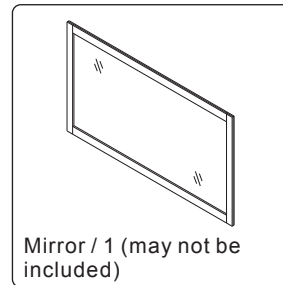
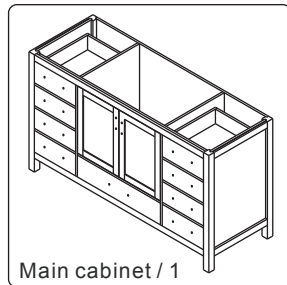
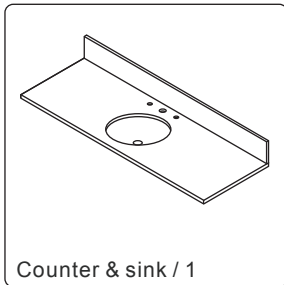

HOW TO ADJUST HINGES (if required)

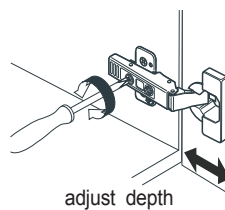
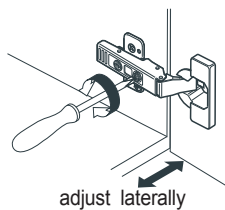
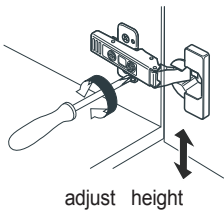

REQUIRED TOOLS NOT IN BOX

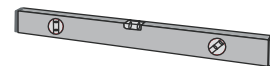
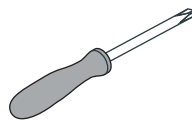
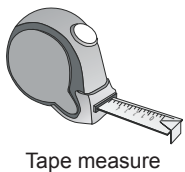

WC-1414-60 Single Installation Guide

WYNDHAM COLLECTION

INSTALLATION INSTRUCTIONS

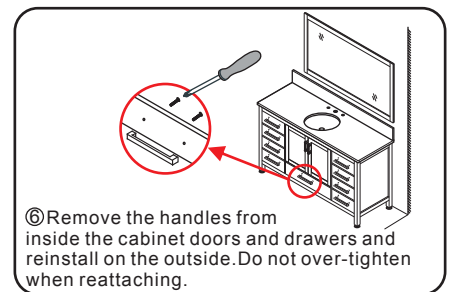
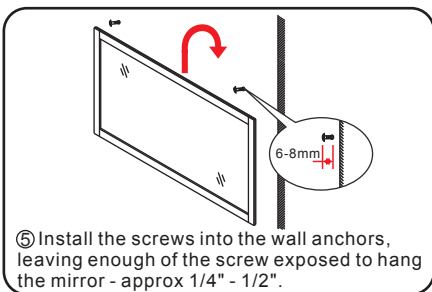
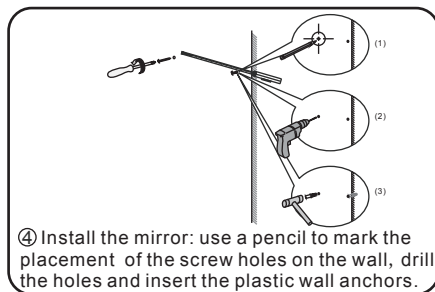
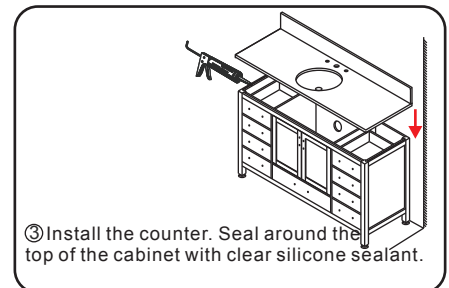
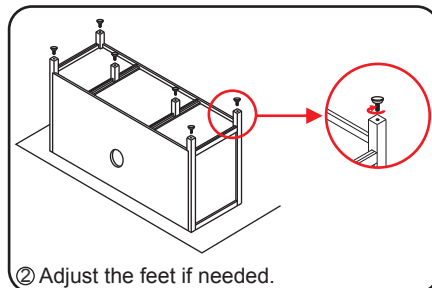
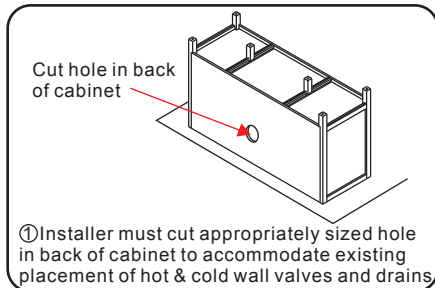

WC-1414-60 Single
Installation Guide

WYNDHAM COLLECTION

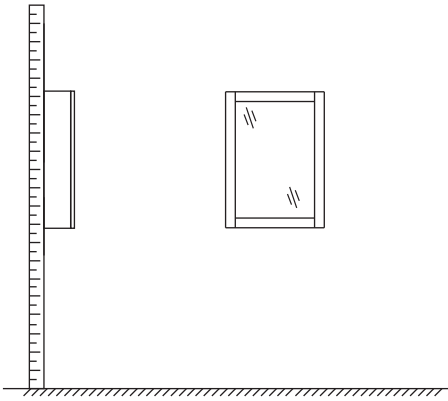

- Prior to installation please check received items against the "Packing List". Please report any missing items to your retailer immediately.
- Protect all surfaces from sharp objects, high heat sources, direct prolonged sunlight and chemical hazards.
- Professional installation recommended.

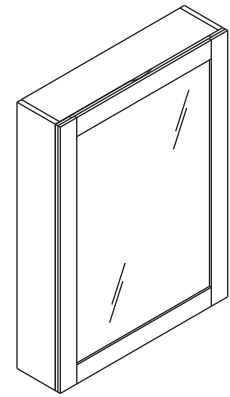

PACKING LIST

(Components may be different depending on your order)

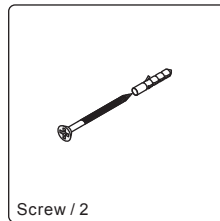
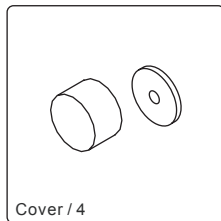
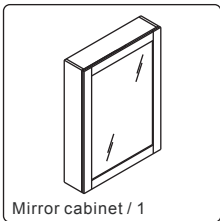

ADJUSTMENT OF HINGES (if required)

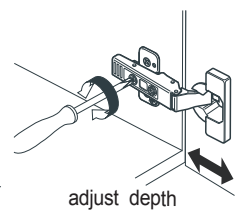
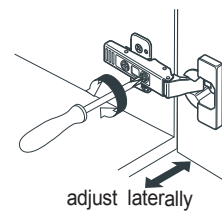
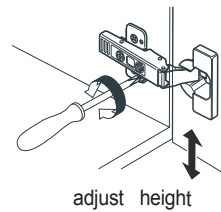

REQUIRED TOOLS NOT IN BOX

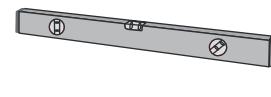
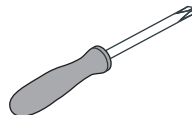
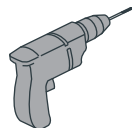
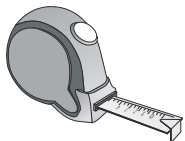

INSTALLATION INSTRUCTIONS

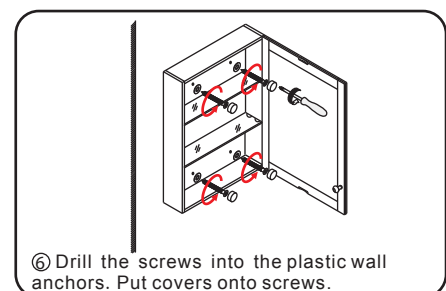
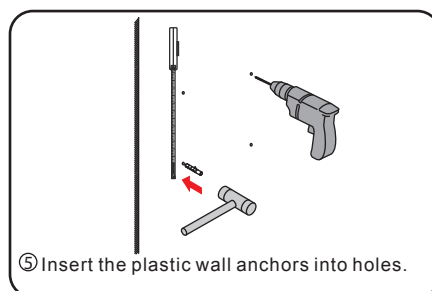
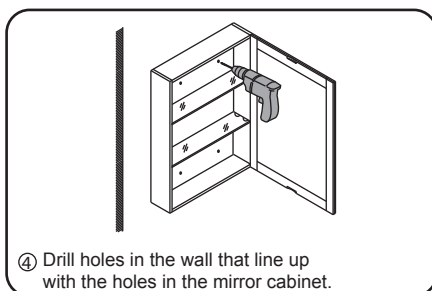
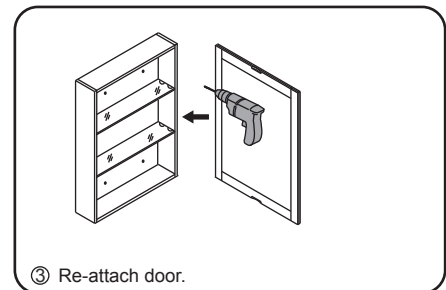
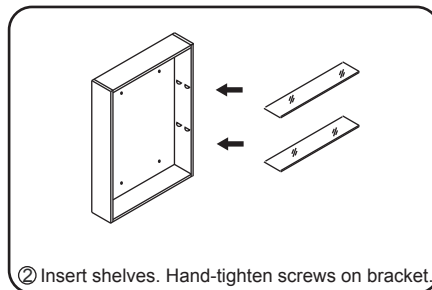
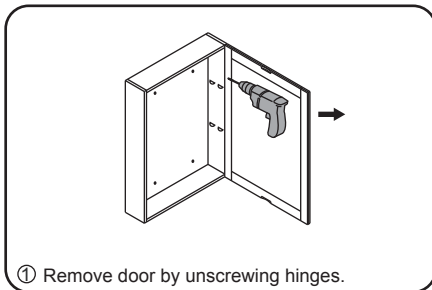

WC-1414-MC24
Installation Guide