

THROUGH - THE - WALL AIR CONDITIONER SLEEVE INSTALLATION INSTRUCTIONS

• TTW Sleeve with Expanded Grille: AXSVA1

SLEEVE HARDWARE

ITEM	DESCRIPTION	QTY
①	SLEEVE ASSEMBLY	1
②	WEATHER PANEL (BACK, FRONT)	2
③	EXPANDED ALUMINIUM REAR GRILLE	1
④	SUPPORTER	8
⑤	WASHER SCREW	14

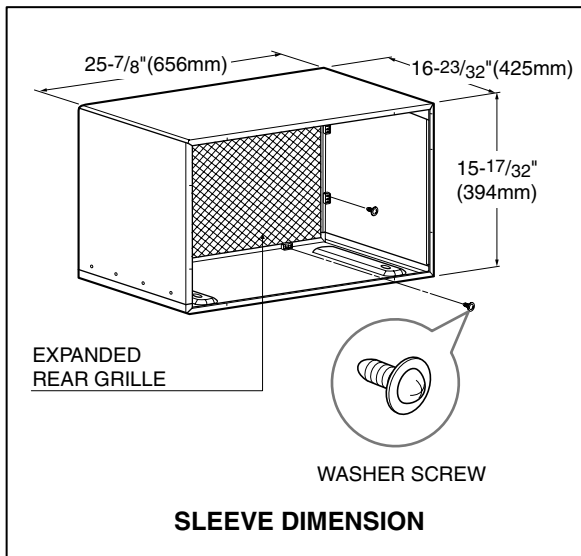
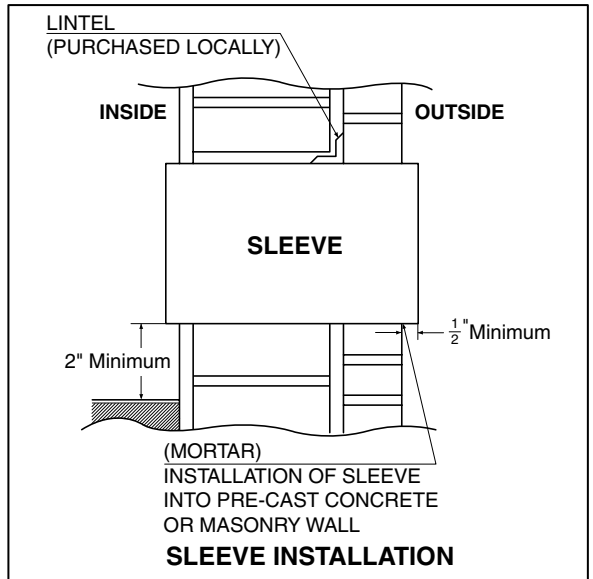
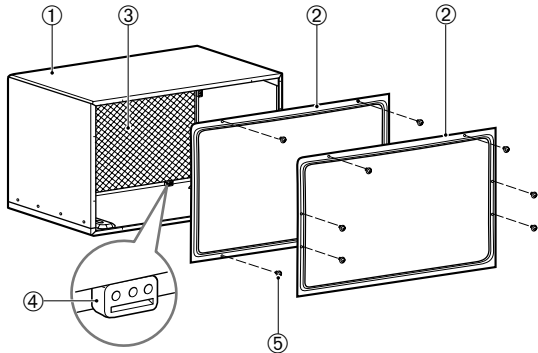

INSTALL THE UNIT

- Remove the old air conditioner from the existing wall sleeve and remove the existing wall sleeve.
- Prepare and install the new wall sleeve into the wall opening.
- The wall sleeve must be fastened in the wall securely before installing the new air conditioner.
- Keep the cover panels for later use to protect the unit from rainy or windy weather.
- Receptacle should be installed within 20" of left side or 45" of right side of wall opening.
- To avoid distortion to plastic air conditioner front, install sleeve 4" minimum distance from heating source. (e.g. Baseboard heating, radiator, etc.)
- After sleeve has been installed, caulk where necessary entire perimeter around exterior wall opening and sleeve. Use a good grade of caulking compound to seal all cracks against air and water infiltration.
- Do not remove front or back cover until all masonry is set and window frame is in place. this will prevent buckling of the during subsequent construction operations. the rear grille and washer screws should be kept well until the air conditioner is installed.

