



The World's Best Massage Chairs

**Infinity Massage Chairs
72 Stard Road
Seabrook, NH 03874**

**603-347-6006
www.infinitymassagechairs.com**



The World's Best Massage Chairs

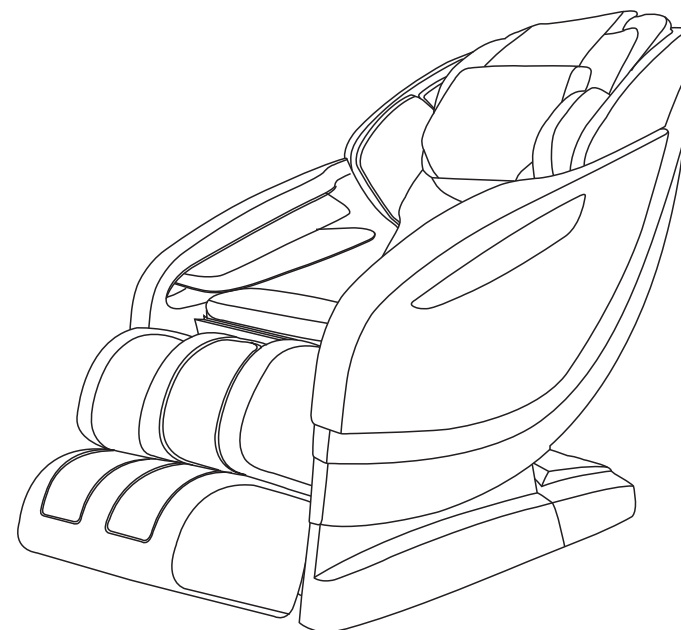

INFINITY

ALTERA
USER MANUAL

Thank you for your purchase of this massage chair. Before use, please read this USER MANUAL carefully, and pay special attention to the safety precaution to ensure proper operation and use.

CONTENTS

SAFETY PRECAUTIONS	1
NAME AND FUNCTION OF EACH COMPONENT	3
External structure	3
Internal structure	3
Power box	4
Controller	5
Controller Buttons	6
LCD screen	8
FUNCTIONS	9
PRECAUTION BEFORE USING	10
Installation Method	11
Machine adjustment	11
Before sitting down	13
Move method	13
Turn on power supply	14
Installation position	14
Floor protection	15
Surrounding environment	15
Grounding	15
PRODUCT STORAGE AND MAINTENANCE	16
TROUBLE SHOOTING	17
TECHNICAL SPECIFICATION	18

▶ TROUBLE SHOOTING



No.	Problem	Possible Cause	Solution
1	The sound of Shu shu and ta ta is heard.	It is a normal sound made by the working motor or the sound is produced when the massage ball is rubbed against the cloth cover.	It is normal.
2	The machine can not be started up.	The power supply plug is detached.	Insert the power supply plug into the socket again.
		The power supply switch is not turned on.	Turn on the switch
		The fuse of massage chair blew out.	Replace a new one with the same mode
3	The airbag installed at seat cushion or legrest can not work.	There may be an air tube blockage.	Clear the air tube.

If the issue still remains after the above measures have been taken, please contact technical support at 603-347-6006 for repair and maintenance.

Please Note: Do not dismantle the massage chair by yourself. Infinity Massage Chairs is not responsible for product damages or personal injury caused by improper use. Thanks for your cooperation.

▶ SAFETY PRECAUTIONS





⚠ CAUTION

 MASSAGE CHAIR PRECAUTIONS	<ul style="list-style-type: none"> ◆ Please put the massage chair on flat ground for use. ◆ When adjusting the legrest or backrest, please do not use excessive force. Additionally, keep children and pets clear of chair. ◆ When removing power plug, please hold the insulation plug, do not pull power cord. ◆ Please do not use the power supply that is beyond the specified electric voltage, as this may cause fire risk or damage to massage chair. ◆ Before using, please uncover the back cushion to check whether backrest or fabric is damaged; if damaged, please stop using this massage chair immediately, and contact manufacturer for repair immediately. ◆ Please do not operate the controller with damp hands, and do not put heavy objects on controller. ◆ Max Weight Capacity: 265 lbs ◆ Please do not use other therapeutic equipment in combination with this massage chair. ◆ If you feel any pain or discomfort during use, please stop use immediately and consult your doctor. ◆ This massage chair is designed and intended for non-commercial household use only. Do not use the massage chair for medical treatment. ◆ This massage chair is equipped with a heating function. People who are sensitive to heat should consult their doctor prior to use and practice caution during use. ◆ Always switch off power and remove the plug from the mains socket immediately after use and before cleaning.
 PROHIBITED	<ul style="list-style-type: none"> ◆ To avoid causing discomfort, do not use the massage chair immediately after meals. ◆ Do not fall asleep in the massage chair during operation. ◆ Do not use the massage chair while intoxicated. ◆ If the upholstery becomes dirty, use only high-quality leather cleaner. Do not use chemical cleaners, petrol, detergents, etc. Do not spray pesticide on the massage chair. ◆ Do not sit on backrest, legrest, or armrest to avoid accidental injury or damage to massage chair. ◆ Please do not smoke while using the massage chair.
 REMOVE PLUG	<ul style="list-style-type: none"> ◆ Before maintenance, please pull out power plug. In addition, please do not insert or unplug the power plug with damp hands, to avoid electric shock. ◆ When the massage chair is not in use, please switch off power and remove the plug from socket. When power is off, please cut off power supply immediately and pull out the power plug from socket.



▶ SAFETY PRECAUTIONS

Safety Precautions

- ▶ Before using, please read this “SAFETY PRECAUTIONS” carefully to ensure proper operation.

 WARNING	Improper operation may cause injury to users.
 CAUTION	Improper operation may cause users injury or product damage.
	Forbidden. Specific instruction will be indicated in the diagram drawings.
	Compulsory. Specific instruction will be indicated in the diagram drawings.(e.g, the left drawings means to disconnect the power plug)

WARNING

 COMPULSORY	<p>We recommend that those with any of the following conditions consult a doctor prior to using.</p> <ul style="list-style-type: none"> • Those using an electronic medical instrument embedded in the body, such as a cardiac pacemaker, etc. • Those being treated by doctors, especially those suffering with chronic pain and conditions. • Patients suffering with conditions like cancer, heart disease, and those receiving acute care for medical conditions or recovery. • Women who are pregnant. • Those with osteoporosis or spinal injuries. • Those with skin conditions or diseases.
 PROHIBITED	<p>Mentally disabled people should operate the massage chair ONLY under supervision, never alone.</p> <p>Do not allow children to play on this massage chair.</p> <p>Do not allow more than one person to use this massage chair at a time.</p> <p>If the power cord or plug becomes damaged in any way, disconnect it from the main supply immediately and contact technical support at 603-347-6006 for repair or replacement.</p> <p>To prevent damage, do not excessively bend, pull, twist, or not the power cord.</p> <p>Massage chair use not recommended for children.</p>
 NO DISASSEMBLY	<p>Anyone other than maintenance personnel specified by our company should not disassemble, maintain, or remodel this massage chair. If you experience problems, please contact Infinity Massage Chairs immediately.</p>

▶ TECHNICAL SPECIFICATIONS

Model: **ALTERA**

Rated voltage: 110V

Rated frequency: 50/60 Hz

Rated power: 200W

Safety design: Class I

▶ NAME AND FUNCTION OF EACH COMPONENT

External structure

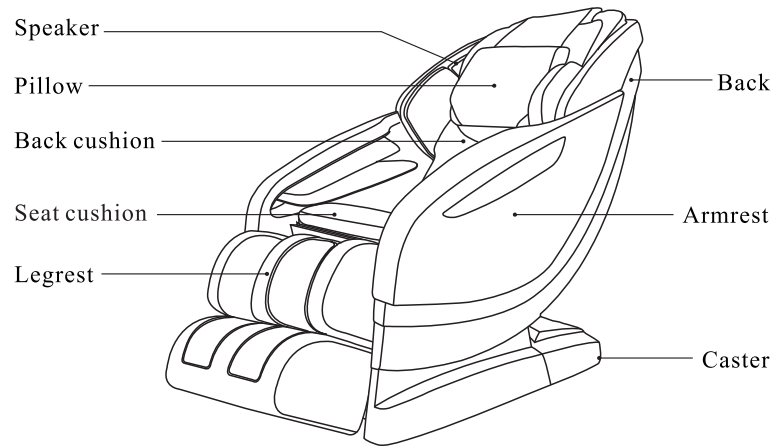

Internal structure

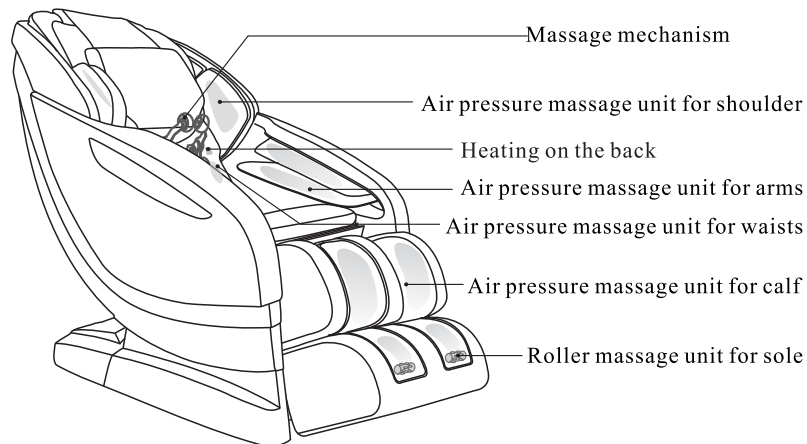

▶ PRODUCT STORAGE AND MAINTENANCE

Maintenance

- ▶ Dip a cotton cloth in a neutral detergent, twist out excess solution, and use it to wipe the back cover, hand rest, legrest, air tube, and other plastic components. Then use a dry cotton cloth to wipe them again.
- ▶ Use dry cloth to wipe the controller and power supply box.
- ▶ Use a cloth dipped in a neutral detergent to wipe the back cushion and pillow, then use a water-dampened cloth to wipe them, and finally, put them in a well-ventilated area to air-dry.

⚠ Caution

- ▶ Make sure to pull out the power supply plug prior to maintenance. Do not use wet hands to remove the plug in order to avoid electrical shock. When cleaning the back cover, avoid getting detergent in the power supply box.
- ▶ Do not iron the upholstery.

Storage method

- ▶ Wipe down the product after use. If the product is not to be used for a long period of time, cover it with a dust cover (not provided with the massage chair).

⚠ Caution

- ▶ Do not store the massage chair under direct sunlight or in places of extreme temperatures. This may cause the color of the upholstery to fade.

⚠ Caution

- ▶ If any unusual symptom occurs, please stop using the massage chair to avoid breakdowns and accidents.
- ▶ Turn off the power supply switch and pull out the power supply plug, then contact technical support at 603-347-6006 for repair and maintenance.
- ▶ Except for normal operation and maintenance mentioned above, any other repair and maintenance should be performed **ONLY** by an authorized dealer or service agent.

► PREPARATION BEFORE USING

Installation position

Safety distance for the periphery of massage chair.

- Please make sure there is adequate space for massage chair installation:

Back: Minimum of 4 inches from the wall or any other blocks

Front: Minimum of 20 inches from any blocks

- In order to prevent signal interference, please keep at least 3 feet away from the TV, radio, and other video and audio devices.

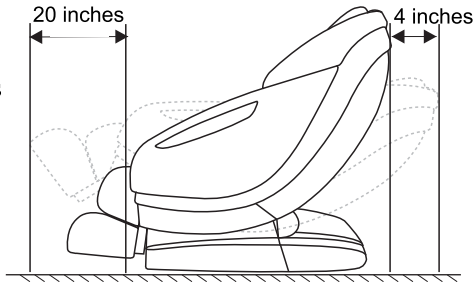

Floor protection

- Place the massage chair on carpet or other padding in order to avoid unwanted scratches, scuffs, or markings on the floor.

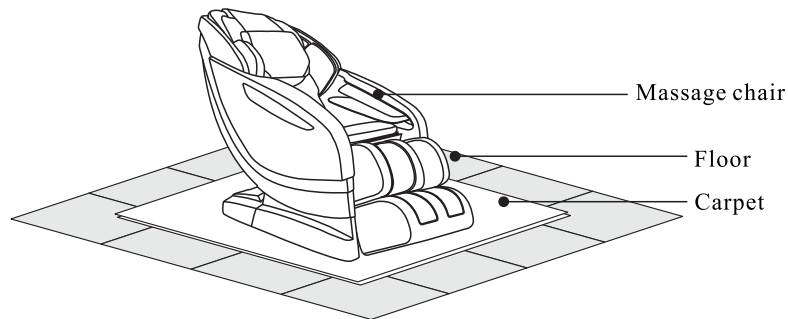

Surrounding environment



Keep the massage chair out of damp areas (e.g.: bathroom) to avoid electrical damage or shock.



Keep the massage chair away from sources of high temperatures (e.g.: stove) to avoid fire or damage to upholstery.

Grounding

This massage chair is a Level One electrical appliance. Make sure to use a three-core power supply socket and to guarantee the ground wire connected to the power supply socket has obtained good ground connection to avoid electrical damage, shock, or other issues during use.

► NAME AND FUNCTION OF EACH COMPONENT

Power box

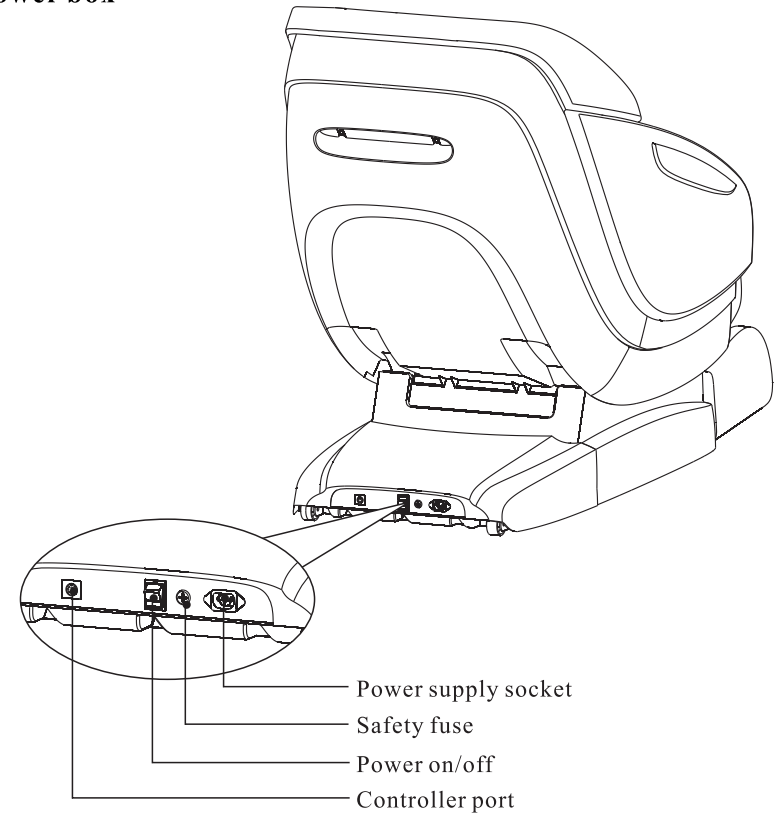

⚠ Caution

- To prevent accidents or damage to the power supply box, do not allow children to play on the massage chair.
- Please power off the chair and unplug it from the power supply socket after use.
- Shut down and unplug the chair from the power supply socket when it is not in use to prevent accidents or damage.
- Store the chair if it will not be used for a long period of time.

▶ NAME AND FUNCTION OF EACH COMPONENT

Controller

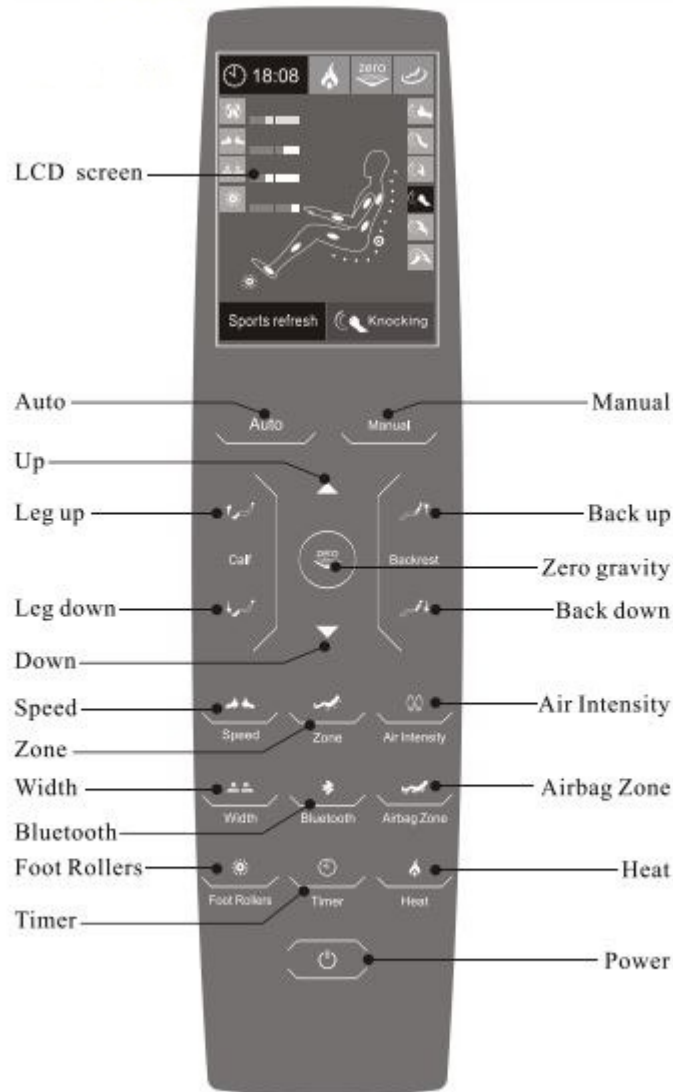

▶ PREPARATION BEFORE USING

Move method

- ▶ There are rollers on the bottom of the chair to aid in moving.
- ▶ Raise the back of the chair to its highest point.
- ▶ Turn off and unplug the chair.
- ▶ Lift the front part of the chair as shown in the figure below (one person should raise the front part by holding the moving handle, while another holds the top of the chair and pushes it from behind). You will be able to move the chair by the rollers.

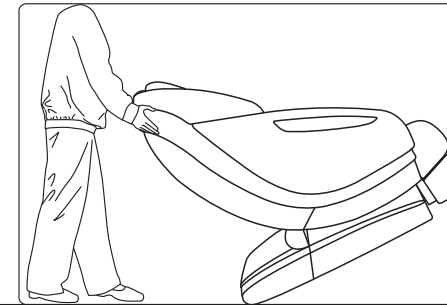

⚠ Caution

- ▶ Don't move the chair when someone is sitting in it.
- ▶ Don't use the armrest to move the chair. Only hold the moving handles in the back and front.

Turn on power supply

- ▶ Plug the power cord into three core socket with well grounding.
- ▶ Turn on the power switch on the bottom of massage chair.

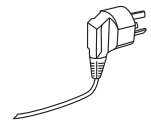

⚠ Caution

- ▶ Before switching on the chair, please make sure there is no damage on the power wire and other exposed wires.
- ▶ Make sure the power switch is off before the chair is connected to electricity.

► PREPARATION BEFORE USING

Massage chair Setup

- ▶ Using the controller, put the backrest in the lowest position and raise the legrest to the highest position. Then move the chair into position, making sure there is enough room around the chair so that it will not make contact with any walls, objects, etc.
- ▶ Test all of the functions of the chair and make sure everything is working as expected. When finished, shut off the chair and turn off the power.

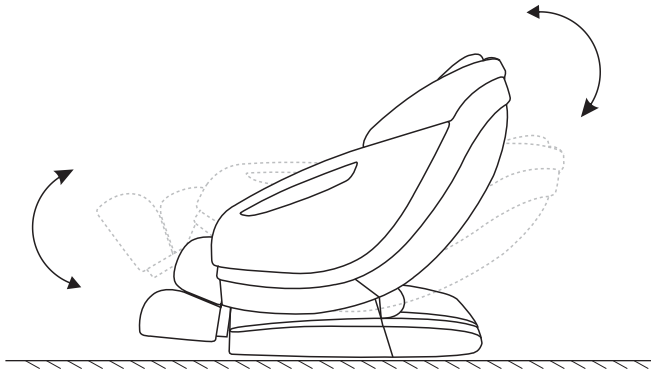

Before sitting in the chair

- ▶ Make sure the legrest is installed properly.
- ▶ Make sure the chair is in the original position. If any part is not in the initial position, power it on and then off again to put it back in its original position.

⚠ Caution

- ▶ Never sit in the chair if the legrest is not in its original parked position.
- ▶ Never use excessive force or place any heavy load on the legrest suddenly, as this could cause damage.

► NAME AND FUNCTION OF EACH COMPONENT

Controller Buttons



Power: to start/end massage function of the chair

- ▶ When the chair is plugged in, press this button to start up the chair and activate the LCD screen. You can then choose Auto, Manual, Airbag, Heating, and Roller Massage functions.



Auto

- ▶ Press this button to enter Auto menu. Choose from the Extension, Working Relief, Sports Refresh, Rest & Sleep, Neck & Shoulder, or Waist & Spine massage programs according to your preferred massage style and massage time. (See the LCD menu for details.)





Manual

- ▶ Press this button to access the Manual programs menu. You can choose from Shiatsu, Rubbing, Tapping, Knocking, Kneading, Sync, or Rhythm massage mode based on your preferences. (See the LCD menu for details.)



Leg up and down

- ▶ Keep pressing “”, the leg rest raises to the highest; stop pressing, the leg rest stays.
- ▶ Keep pressing “”, the leg rest descends to the lowest; stop pressing, the leg rest stays.





Zero Gravity

- ▶ Press this button to start (and end) the zero gravity function. The icon will light up on the LCD screen. When you manually adjust the backrest and legrest, if the icon is off, it is in the zero gravity state.
- ▶ Zero gravity creates a completely relaxing, naturally comfortable massage position by placing the back, buttocks, and legs at a certain angle similar to lying in a space capsule. The zero gravity position relieves the body of pressure and helps muscles relax.





Shoulder Position adjustment

- ▶ When the massage chair is in manual mode, continue pressing “” or “” to adjust the point of massage.
- ▶ These buttons are also used for shoulder position adjustment.



Backrest up and down

- ▶ Keep pressing “”, the backrest raises to the highest; stop pressing, the backrest stays.
- ▶ Keep pressing “”, the backrest descends to the lowest; stop pressing, the leg rest stays.

NAME AND FUNCTION OF EACH COMPONENT



Massage force adjustment

- ▶ Under manual mode, press this button to choose from 6 different degrees of massage force, which is indicated on the LCD screen.



Zone

- ▶ In manual mode this button allows the selection of having the massage work on the whole back, just a portion of the back, or point mode to select a specific single spot for concentrated massage.



Air Intensity

- ▶ Press this button to choose from 5 different degrees of air bag intensity, which shows in the LCD screen.



Width

- ▶ Under manual mode, if the button is lit, it is ready for operation. Press this button to choose wide, medium, or narrow massage width. The indicator light will be on or off.
- ▶ If the button is not lit up, this function is not available.



Bluetooth

- ▶ Use this button to turn on/off the Bluetooth feature. The icon will light up on the LCD.



Airbag Zone

- ▶ Press this button to start or end shoulder, leg, seat, whole body airbag massage. Indication on the LCD is on or off.



Foot Roller massage adjustment

- ▶ Press this button to start or end the foot roller massage. You can choose from high, medium, or low modes. There is an icon on the LCD screen.



Time

- ▶ Press this button to choose length of massage: 10 mins, 20 mins, or 30 mins.



Heating

- ▶ Press this button to start heating function on back and seat (icon will be lit up). Press it again to turn off heating function (icon light will be off).

PREPARATION BEFORE USING

- ▶ Lift the calf massage unit, then connect the air tube and air valve plug unit into the ports on the seat base and make sure they are fastened.

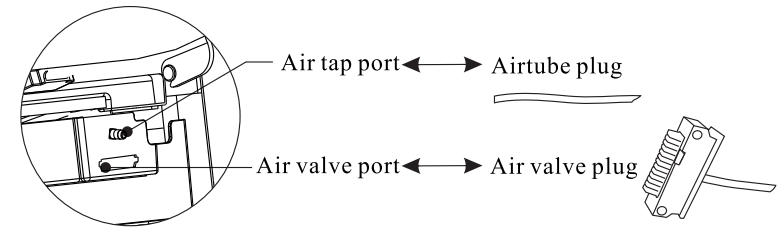

Step 3 Installation of other units

- ▶ Insert the plug of remote control into the socket on the power box at the bottom.
- ▶ Connect the power cord connector to the power cord port on the power box. (See diagram below)

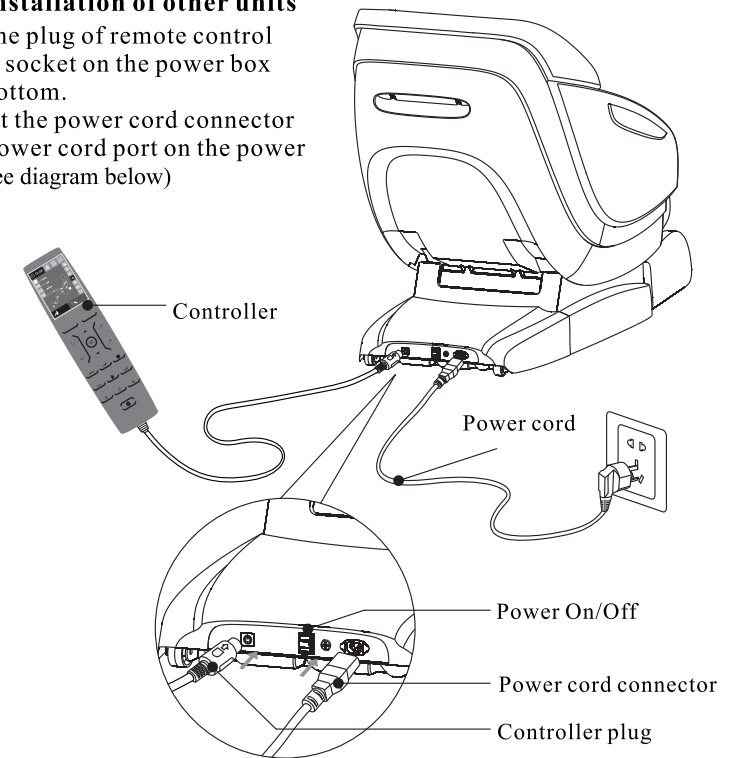

- ▶ After all parts are assembled, insert the power cord into the power socket, turn on the switch, and press the power on the remote control to start massage. (See diagram above)

► PREPARATION BEFORE USING

Installation method

Step 1: Take out the massage components

- Open the boxes and take out the accessory box.
- Ensure that all components are complete. (Please check one by one according to list.)

Step 2: Install legrest kit

- Remove the legrest from the box. Connect the hook to the coupling shaft on one side, then connect on the other side. Center the legrest on chair and shafts.

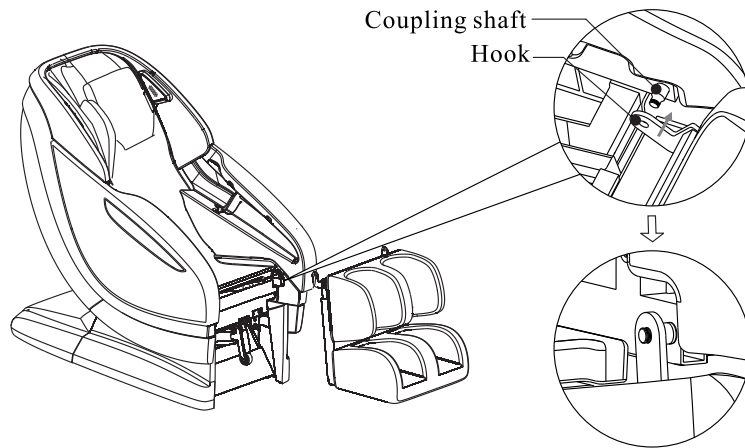

- After the legrest is balanced on the coupling shafts, fasten both sides with the lock clips as shown below.

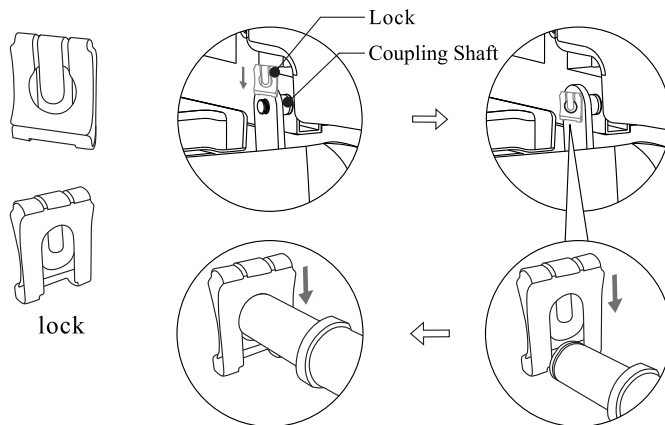

► NAME AND FUNCTION OF EACH COMPONENT

LCD screen

Auto programs

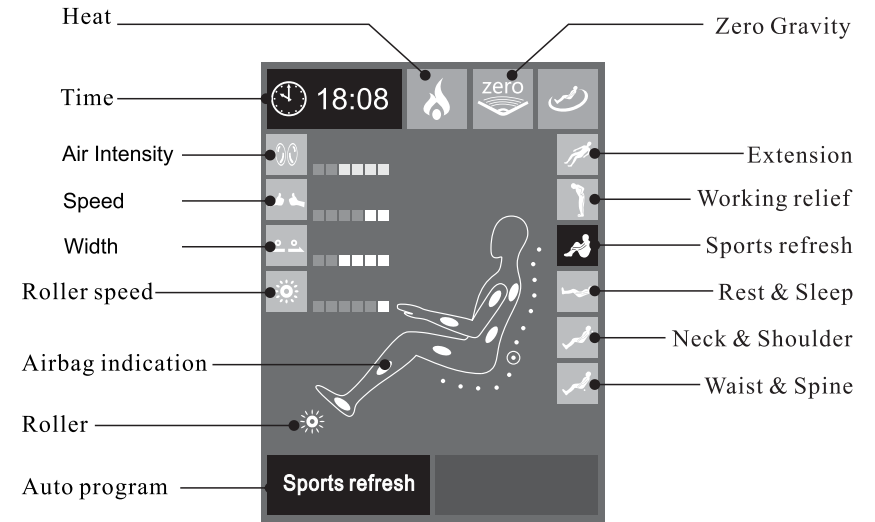

Manual programs

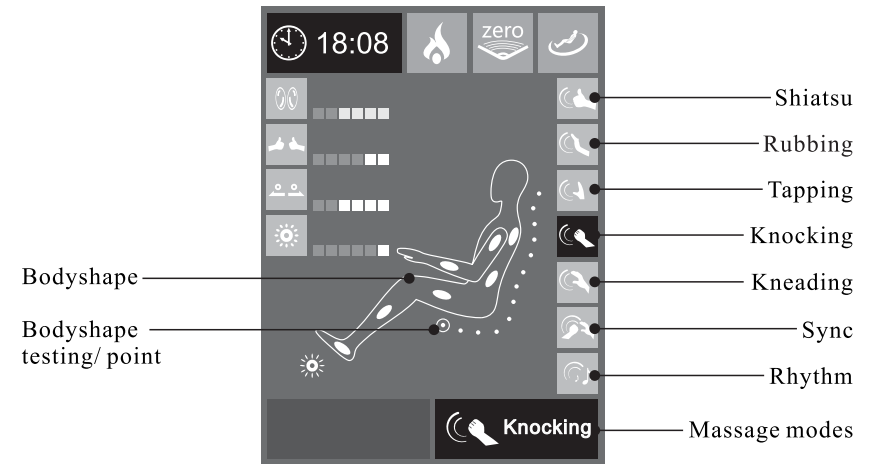

▶ NAME AND FUNCTION OF EACH COMPONENT

LCD Menu

▶ Auto programs

With electricity connected, press the power button and the LCD screen will come on. Press Auto to enter the Auto program menu. Then, choose from Extension, Working relief, Sports Refresh, Rest & Sleep, Neck & Shoulder, or Waist & Spine. (See image below)

Extension:

This program utilizes Thai massage techniques. The strong kneading and stretching of the body effectively stretches the legs, waist, and more. It's the best choice to relax tired muscles and increase physical vigor.

Working Relief:

This is an exclusive massage program designed for desk workers. People who spend long periods of time sitting at a desk or traveling will find this massage can ease muscle tension and recuperate the entire body.

Sports Refresh:

This is designed to relieve muscles after sports activities and exercise. It eases and relaxes muscles after intense exercise and promotes the body's circulation system to help speed up muscle recovery after exercise.

Rest & Sleep:

This gentle program is perfect for lunch breaks and improving sleep. The mild massage starts with powerful kneading that gradually becomes lighter, eventually using a barely-there feeling to help soothe the tired body.

Neck & Shoulder:

This massage relieves neck and back pain symptoms. This program will spend 80% of the massage time focusing on the shoulders and neck. The S-shaped backrest allows the massage rollers to completely touch the shoulders and neck, thus relieving fatigue and stiffness of these areas.

Waist & Spine:

This massage is to relieve the symptoms of lumbar spine pain. 80% of the massage time will focus on the lumbar spine and the rollers will conduct specific area massage to relieve the sense of tension and keep the health of this part.

▶ Manual programs

With electricity connected, press the power button and the LCD screen will come on. Press Manual to enter the Manual program menu. Then, choose from Shiatsu, Rubbing, Tapping, Knocking, Kneading, Sync, or Rhythm. (See image above)

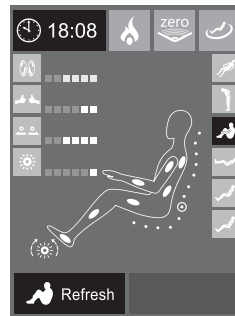

Auto programs interface

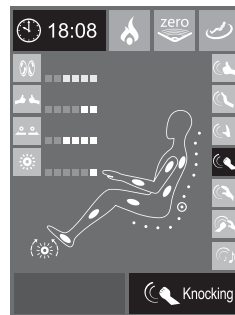

Manual programs interface

▶ FUNCTIONS

• Bluetooth Audio Features

This massage chair is designed to play music using Bluetooth technology. It can play music when connected to an Android mobile device, iPhone, iPad, or other compatible tablet computer.

• Zero Gravity

This chair uses the NASA zero gravity principle, elevating the legs above the heart and imitating weightlessness. This position is known to increase comfort and release stress.

• Four-roller Massage Mechanism

The innovative four-roller massage mechanism and S-shaped track perfectly complements the human spine.

• Six Levels of Massage Intensity

Choose from 6 levels of massage intensity, selectable in manual mode. You can select suitable massage intensity according to your body condition and massage time.

• Air Pressure Massage

Enjoy air pressure massage for the back, waist, shoulders, arms, buttocks, calf, and feet.

• Touchable Buttons

For people who prefer the tactile feel of real buttons, this chair does not have a touch screen or hidden menus. All functions are selectable from the face buttons on the remote.

• Roller Massage for Sole

Double-row rollers massage the soles and provide a full Shiatsu massage to the feet.

⚠ WARNING

- ▶ This massage chair has a heated surface. People sensitive to heat must be careful and should consult a doctor prior to using.
- ▶ People and children with compromised physical, sensory, or mental capabilities, as well as those with lack of product experience and knowledge, should not use the massage chair unless given supervision or instructions. All users should first have a full understanding of how to safely use the massage chair, as well as the hazards involved.
- ▶ Do not allow children to play with the massage chair. Children also should not clean or maintain the massage chair without supervision.