

Assembly Instructions

Caution : You must read this before you proceed

Umbrella Base

Reminder : Maximum diameter for open Umbrella - 80 inches

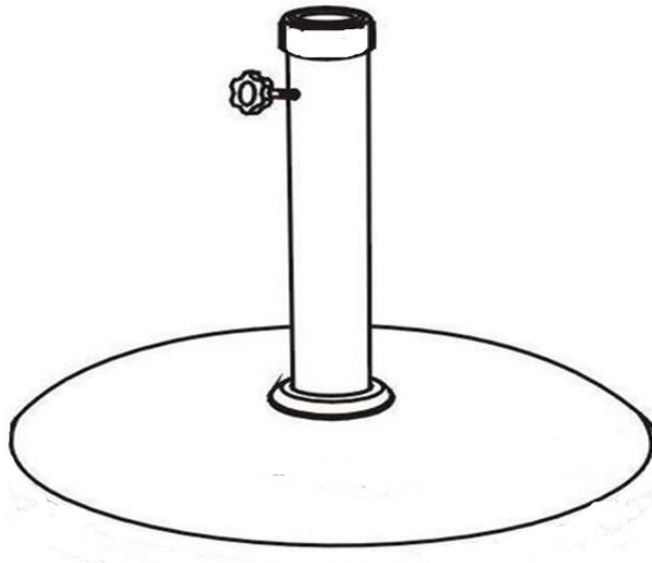



Parts List

Label	Picture	Description	QTY
A		Umbrella Base	1
B		Support Pole	1

Hardware

①		Nut	1
②		Washer	1

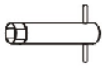
③		38mm & 48mm Adapter	1
④		Gasket	1
⑤		Socket Wrench	1

Assembly Preparation

Before Beginning Assembly:

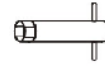
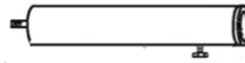
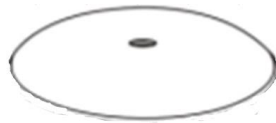

- Read instructions, cover to cover-



- Have 2 adults on hand for assembly-



- Do not assemble on flooring or carpet-



- Assemble on a clean non-marring surface (packing foam)-



- Save all packaging until finished-

WARNING: CHOKING HAZARD. Do not allow children to play with plastic wraps or any small parts in this package.

Notice: As a safety precaution, when your Umbrella is not in use, please close the Umbrella.

Remove Umbrella from this Base and store in safe location

This Base is NOT suited and NOT recommended to be used as a free-standing Umbrella Base.

This Base must be used under a matching table and matching Umbrella size.

ATTENTION: This Umbrella Base is exclusively recommended to be used together under a table with the matching Umbrella with diameter of 71 inches to 80 inches.

The matching Support Pole diameter: 38mm - 48mm.

Assembly Steps

Overview

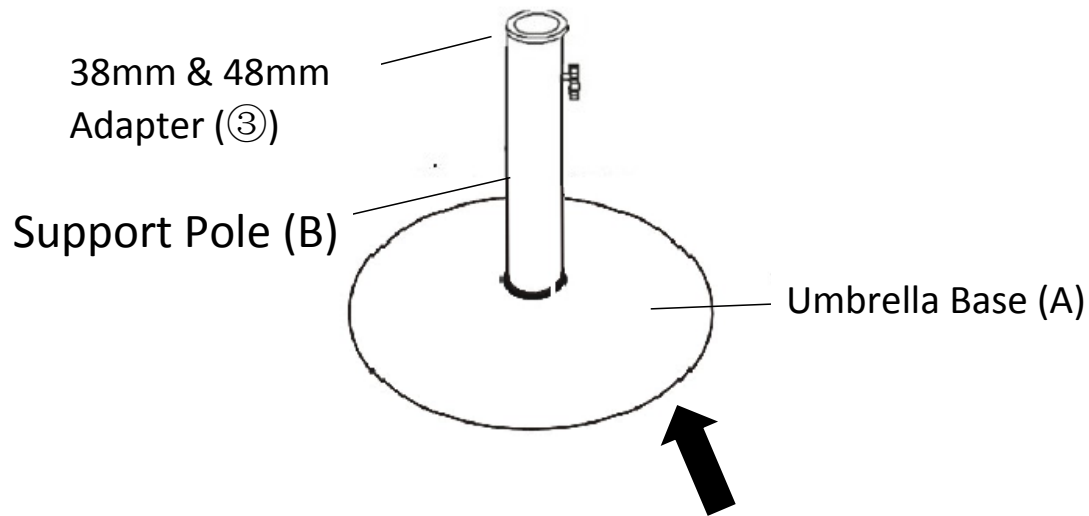

FRONT FACING

This Umbrella Base has multiple parts and may require up to 30 minutes to assemble. To give you an overview of the Umbrella parts, the above picture is to help you put the various parts into perspective. Please read through the instructions below to familiarise yourself with the parts and steps before assembly.

Step 1

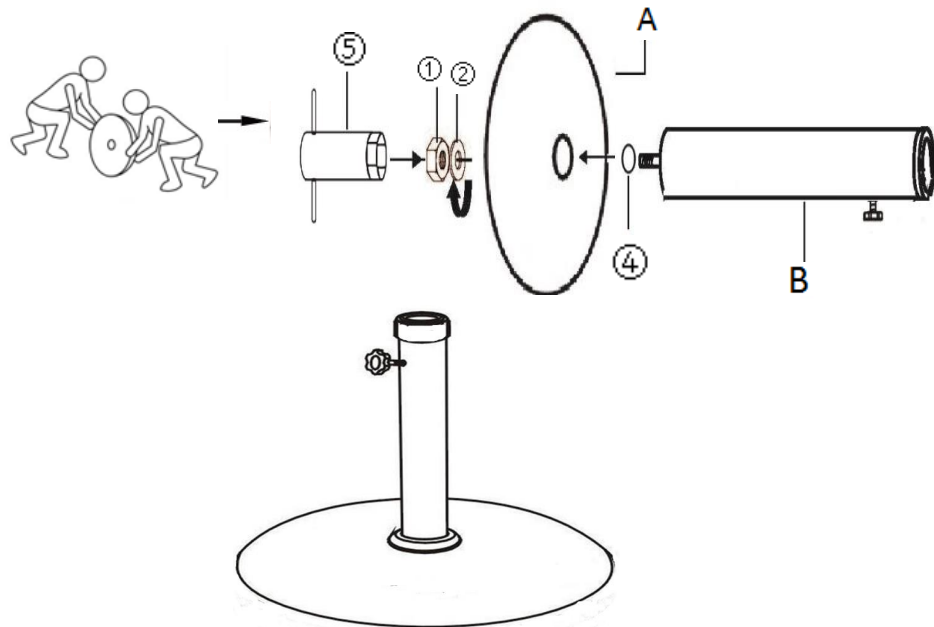

This is a two person team assembly product.

Tilt the Umbrella Base to its side as pictured.

Attach Support Pole(B) and Gasket(④) to Umbrella Base(A) using Washer(②) and Nut(①) with Socket Wrench(⑤).

Tighten Bolt until fully secure.

Operation Instruction

For Umbrella Pole with 48mm diameter:

Insert the 38mm & 48mm Adapter(③) into the Support Pole(B). Pull out the 38mm Adapter; Then insert your 48mm Umbrella Pole. Tighten the Adjustable Screw on the Support Pole to secure your Umbrella Pole.

The Umbrella Base is ready for use.

This Umbrella Base only be used on a flat, level surface.

For Umbrella Pole with 38mm diameter:

















Insert the 38mm & 48mm Adapter(③) into the Support Pole(B).

Then insert your 38mm Umbrella Pole. Tighten the Adjustable Screw on the Support Pole to secure your Umbrella Pole.

The Umbrella Base is ready for use.

This Umbrella Base only be used on a flat, level surface.

Care & Maintenance

-   ● Do not put hot items directly on furniture surface
 -   ● Do not clean furniture with harsh cleansers or polish.
 -   ● To obtain the longest lifespan of your outdoor products, minimizing exposure to direct sunlight is recommended.
 -   ● Children should not climb or jump on the furniture.
 -   ● To obtain the longest lifespan of your outdoor products, avoid extended and lengthy exposure to rain, snow, and direct sunshine. Whenever possible cover the product and /or place under patio or awnings.
 -   ● Not for commercial use. For residential use only .
 -   ● Stains may be removed with mild soap solution and damp cloth.
-
-   ● Dust and pick-up spills using a clean, non-colored, lint-free cloth .

What is Proposition 65?

Proposition 65 is a California law that requires warning labels on products that may contain one of more than 800-plus chemicals or ingredients that the California Office of Environmental Health Hazard Assessment (OEHHA) has deemed to cause cancer or other reproductive toxicity. Chemicals and elements on this list include wood dust, brass, and other everyday substances, which can be found in very common household items, such as: lamps, tableware, jewelry, crystal glasses, electric cords, beauty products, automobiles, and furniture.

Why Did I Find a Proposition 65 Warning on My Home Goods Product?

We include Proposition 65 warnings on all of our products because there is always a chance that one of the 800-plus common chemicals and ingredients listed under this law could potentially be on our furniture or packing materials. We risk large fines under this law, if we don't include this warning.

Should I worry?

We realize you may be worried finding this warning on our products, but we want to reassure you that the hazardous exposure limits for any of these chemicals have never been found on furniture products that we've shipped to our customers. Additionally, this warning label is very common and can be found on almost every piece of furniture sold in the state of California.

Just How Common Are Proposition 65 Warnings?

Proposition 65 warnings have become so common in California that it is hard to take a trip to a local bank, grocery store, or restaurant without finding at least one warning. In fact, even the Disney Land Resort has a Proposition 65 warning:

